



## POLIZEITRUCK/ FEUERWEHR LEITERWAGEN/ BAGGER/ ABENTEUER JET POLICE TRUCK/ FIRE ENGINE/ EXCAVATOR/ JET ADVENTURE CAMION DE POLICE/ CAMION DE POMPIERS AVEC ÉCHELLE/ PELLETEUSE/ JET FANTASTIQUE

 DE  AT  CH  GB  IE  FR  BE  NL  PL  CZ  SK  ES  DK  IT  HU  CZ  DE22397 Hamburg GERMANY

**POLICE TRUCK/ FIRE ENGINE/ EXCAVATOR/ JET ADVENTURE/ LORRY**  
Instructions for use

**CAMION DE POLICE/ CAMION DE POMPIERS AVEC ÉCHELLE/ PELLETEUSE/ JET FANTASTIQUE/ CAMION**  
Notice d'utilisation

**POLITIEVRACHTWAGEN/ BRANDWEER LADDERWAGEN/ GRAAFMACHINE/ ADVENTURE-JET/ VRACHTAUTO**  
Gebruiksaanwijzing

**ZESTAW DO ZABAWY- CIĘŻARÓWKA POLICYJNA/ ZESTAW DO ZABAWY- WÓZ STRAŻACKI Z DRABINĄ/ ZESTAW DO ZABAWY- KOPARKA/ ZESTAW DO ZABAWY- ODRZUTOWIEC PRZYGODOWY/ SAMOCHÓD CIĘŻAROWY**  
Instrukcja użytkownika

**POLICEJNÍ NÁKLADNÍ AUTO/ HASIČSKÉ AUTO SE ŽEBŘÍKEM/ BAGR/ DOBRODRUŽNÁ VESMÍRNÁ LOĎ/ NÁKLADNÍ AUTOMOBIL**  
Návod k použití

**POLICAJNÉ NÁKLADNÉ AUTO/ HASIČSKÉ AUTO S REBRÍKOM/ BAGER/ DOBRODRUŽNÁ STÍHAČKA/ KAMIÓN**  
Navod na používanie

**CAMIÓN DE POLICÍA/ COCHE DE BOMBEROS CON ESCALERA TELESCÓPICA/ PALA EXCAVADORA/ JET DE AVENTURAS/ CAMIÓN**  
Instrucciones de uso

**LEGETØJSSÆT „POLITILASTBIL“/ LEGETØJSSÆT „STIGEVOGN“/ GRAYVKO/ EBVENTYR-JET/ LASTBIL**  
Brugervejledning

**CAMIONETTA DELLA POLIZIA/ CAMION DEI POMPIERI/ ESCAVATORE/ JET AVVENTURA/ CAMION**  
Istruzioni d'uso

**RENDŐRKAMION/ LÉTRÁS TÚZOLTÓAUTÓ/ KOTRÓGÉP/ JET KALAND/ TEHERAUTÓ**  
Használati útmutató



IAN 425746\_2301



**CL-12805**

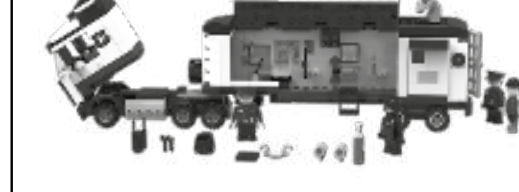

**CL-12806**



Herzlichen Glückwunsch! Mit Ihrem Kauf haben Sie sich für einen hochwertigen Artikel entschieden. Machen Sie sich vor der ersten Verwendung mit dem Artikel vertraut.

**Lesen Sie hierzu aufmerksam die nachfolgende Gebrauchsanweisung.**

Benutzen Sie den Artikel nur wie beschrieben und für die angegebenen Einsatzbereiche. Bewahren Sie diese Gebrauchsanweisung gut auf. Händigen Sie alle Unterlagen bei Weitergabe des Artikels an Dritte ebenfalls mit aus.

**Lagerung, Reinigung**  
Lagern Sie den Artikel bei Nichtbenutzung immer trocken und sauber bei Raumtemperatur. Nur mit einem trockenen Reinigungstuch sauber wischen. WICHTIG! Nie mit scharfen Reinigungsmitteln reinigen.

**Lieferumfang CL-12805**  
489 x Einzelteil  
1 x Stickerbogen  
1 x Aufbauanleitung  
1 x Gebrauchsanweisung

**CL-12806**  
306 x Einzelteil  
1 x Stickerbogen  
1 x Aufbauanleitung  
1 x Gebrauchsanweisung

**KB-11151**  
275 x Einzelteil  
1 x Stickerbogen  
1 x Aufbauanleitung  
1 x Gebrauchsanweisung

**KB-11152**  
387 x Einzelteil  
1 x Stickerbogen  
1 x Aufbauanleitung  
1 x Gebrauchsanweisung

**CL-12809**  
363 x Einzelteil  
1 x Stickerbogen  
1 x Aufbauanleitung  
1 x Gebrauchsanweisung

**Technische Daten**  
Herstellungsdatum (Monat/Jahr): 06/2023  
Hiermit erklärt Delta-Sport Handelskontor GmbH, dass dieser Artikel mit den folgenden grundlegenden Anforderungen und den übrigen einschlägigen Bestimmungen übereinstimmt: 2009/48/EG - Spielzeug-Richtlinie

**Bestimmungsgemäße Verwendung**  
Dieser Artikel ist ein Spielzeug für Kinder ab 5 Jahren für den privaten Gebrauch.

DE/AT/CH

### **Sicherheitshinweise**

- Achtung: Nicht für Kinder unter 36 Monaten geeignet. Erststickungsgefahr. Kleine Teile.
- Kinder dürfen nur unter Aufsicht von Erwachsenen mit dem Artikel spielen.
- Achtung: Alle Verpackungs- und Befestigungsmaterialien sind nicht Bestandteil des Spielzeugs und müssen aus Sicherheitsgründen stets entfernt werden, bevor der Artikel Kindern zum Spielen übergeben wird.
- Prüfen Sie den Artikel vor jedem Gebrauch auf Beschädigungen oder Abnutzungen. Der Artikel darf nur in einwandfreiem Zustand verwendet werden!

**Lagerung, Reinigung**  
Lagern Sie den Artikel bei Nichtbenutzung immer trocken und sauber bei Raumtemperatur. Nur mit einem trockenen Reinigungstuch sauber wischen. WICHTIG! Nie mit scharfen Reinigungsmitteln reinigen.

**Hinweise zur Entsorgung**  
Entsorgen Sie den Artikel und die Verpackungsmaterialien entsprechend den aktuellen örtlichen Vorschriften. Bewahren Sie Verpackungsmaterialien (wie z. B. Folienbeutel) für Kinder unreachbar auf.

Weitere Informationen zur Entsorgung des ausgedienten Artikels erhalten Sie bei Ihrer Gemeinde- oder Stadtverwaltung. Entsorgen Sie den Artikel und die Verpackung umweltschonend.

Der Recycling-Code dient der Kennzeichnung verschiedener Materialien zur Rückführung in den Wiederverwertungskreislauf (Recycling). Der Code besteht aus einem Recyclingssymbol für den Verwertungskreislauf und einer Nummer, die das Material kennzeichnet.

### **Hinweise zur Garantie und Serviceabwicklung**

Der Artikel wurde mit großer Sorgfalt und unter ständiger Kontrolle produziert. DELTA-SPORT HANDELSKONTOR GmbH räumt privaten Endkunden auf diesen Artikel drei Jahre Garantie ab Kaufdatum (Garanziefrist) nach Maßgabe der folgenden Bestimmungen ein. Die Garantie gilt nur für Material- und Verarbeitungsfehler. Die Garantie erstreckt sich nicht auf Teile, die der normalen Abnutzung unterliegen und deshalb als Verschleißteile anzusehen sind (z. B. Batterien) sowie nicht auf zerbrechliche Teile, z. B. Schalter, Akkus oder Teile, die aus Glas gefertigt sind.

Ansprüche aus dieser Garantie sind ausgeschlossen, wenn der Artikel unsachgemäß oder missbräuchlich oder nicht im Rahmen der vorgesehenen Bestimmung oder des vorgesehenen Nutzungsumfangs verwendet wurde oder Vorgaben in der Anleitung/Anweisung nicht beachtet wurden, es sei denn, der Endkunde weist nach, dass ein Material- oder Verarbeitungsfehler vorliegt, der nicht auf einem der vorgenannten Umstände beruht.

Ansprüche aus der Garantie können nur innerhalb der Garanziefrist unter Vorlage des Originalkaszenbelegs geltend gemacht werden. Bitte bewahren Sie deshalb den Originalkaszenbeleg auf.

Die Garanziefrist wird durch etwaige Reparaturen aufgrund der Garantie, gesetzlicher Gewährleistung oder Kulanz nicht verlängert. Dies gilt auch für ersetzte und reparierte Teile. Bitte wenden Sie sich bei Beanstandungen zunächst an die untenstehende Service-Hotline oder setzen Sie sich per E-Mail mit uns in Verbindung. Liegt ein Garanziefall vor, wird der Artikel von uns – nach unserer Wahl – für Sie kostenlos repariert, ersetzt oder der Kaufpreis erstattet. Weitere Rechte aus der Garantie bestehen nicht.

Ihre gesetzlichen Rechte, insbesondere Gewährleistungsansprüche gegenüber dem jeweiligen Verkäufer, werden durch diese Garantie nicht eingeschränkt.

IAN: 425746\_2301

**DE** Kundenservice Deutschland  
Tel.: 0800 5435 111  
E-Mail: deltasport@idli.de

**AT** Service Österreich  
Tel.: 0800 447744  
E-Mail: deltasport@idli.at

**CH** Service Schweiz  
Tel.: 0800 56 44 33  
E-Mail: deltasport@idli.ch

Congratulations! You have chosen to purchase a high-quality product. Familiarise yourself with the product before using it for the first time.

**Read the following instructions for use carefully.**  
Use the product only as described and only for the given areas of application. Store these instructions for use carefully. When passing the product on to third parties, please also hand over all accompanying documents.

**Scope of delivery CL-12805**  
489 x parts  
1 x sticker sheet  
1 x assembly instructions  
1 x instructions for use

**CL-12806**  
306 x parts  
1 x sticker sheet  
1 x assembly instructions  
1 x instructions for use

**KB-11151**  
275 x parts  
1 x sticker sheet  
1 x assembly instructions  
1 x instructions for use

**KB-11152**  
387 x parts  
1 x sticker sheet  
1 x assembly instructions  
1 x instructions for use

**CL-12809**  
363 x parts  
1 x sticker sheet  
1 x assembly instructions  
1 x instructions for use

### **Technical data**

Date of manufacture (month/year): 06/2023

Delta-Sport Handelskontor GmbH hereby declares that this product meets the following basic requirements, as well as other important regulations: 2009/48/EC – Toy Safety Directive

UK CA UK Conformity Assessed  
Delta-Sport Handelskontor GmbH hereby declares that this product meets the following basic requirements, as well as other important regulations: Toys (Safety) Regulations 2011

DE/AT/CH

**Use according to guidelines**  
This product is a toy for children 5 years and up for private use.

### **Safety Instructions**

- Warning. Not suitable for children under 36 months. Choking hazard. Small balls.
- Children may play with this article only under adult supervision.
- Warning. The packaging and mounting materials are not a constituent part of the toy and they must be removed in all cases for safety reasons before the product is given to children to play with.
- Check the product for damage and wear before each use. The product may only be used in good order and condition!

**Storage, cleaning**  
When not in use, always store the product clean and dry at room temperature. Wipe clean with a dry cloth only. IMPORTANT! Never clean the product with harsh cleaning agents.

**Disposal**  
Dispose of the product and packaging materials in accordance with current local regulations. Store the packaging materials (foil bags, for example) out of the reach of children. For further information about disposal of the product no longer needed, contact your local council. Dispose of the product and the packaging in an environmentally friendly manner.

The Recycling Code distinguishes different materials to be returned for recycling. The Code consists of the recycling symbol for the recycling process and a number that identifies the material.

### **Notes on the guarantee and service handling**

The product was produced with great care and under continuous quality control. DELTA-SPORT HANDELSKONTOR GmbH gives private end customers a three-year guarantee on this product from the date of purchase (guarantee period) in accordance with the following provisions. The guarantee is only valid for material and manufacturing defects. The guarantee does not cover parts subject to normal wear and tear that are thus considered wear parts (e.g. batteries) or fragile parts such as switches, rechargeable batteries, or parts made of glass.

GB/IE

Claims under this guarantee are excluded if the product has been used incorrectly, improperly, or contrary to the intended purpose, or if the provisions in the instructions for use were not observed, unless the end customer proves that a material or manufacturing defect exists that was not caused by one of the aforementioned circumstances.

Claims under the guarantee can only be made within the guarantee period by presenting the original sales receipt. Please therefore keep the original sales receipt.

The guarantee period is not extended by any repairs carried out under the guarantee, under statutory guarantees, or as all cases for safety reasons before the product is given to children to play with.

If you wish to make a claim please first contact the service hotline mentioned below or contact us by e-mail. If there is a guarantee case, then the product will be repaired or replaced free of charge to you or the purchase price will be refunded, depending on our choice. Your legal rights, in particular guarantee claims against the respective seller, are not limited by this guarantee.

IAN: 425746\_2301

**GB** Service Great Britain  
Tel.: 0800 404 7657  
E-Mail: deltasport@idli.co.uk

**IE** Service Ireland  
Tel.: 1800 101010  
E-Mail: deltasport@idli.ie

Félicitations ! Vous avez acquis un article de grande qualité. Avant la première utilisation, familiarisez-vous avec l'article.

**Pour cela, veuillez lire attentivement la notice d'utilisation suivante.**  
Lisez l'article uniquement comme indiqué et pour les domaines d'utilisation mentionnés. Conservez bien cette notice d'utilisation. Si vous cédez l'article à un tiers, veuillez à lui remettre l'ensemble de la documentation.

**Contenu de la livraison CL-12805**  
489 pièces  
1 feuille d'autocollants  
1 notice de montage  
1 notice d'utilisation

**CL-12806**  
306 pièces  
1 feuille d'autocollants  
1 notice de montage  
1 notice d'utilisation

**KB-11151**  
275 pièces  
1 feuille d'autocollants  
1 notice de montage  
1 notice d'utilisation

**KB-11152**  
387 pièces  
1 feuille d'autocollants  
1 notice de montage  
1 notice d'utilisation

**CL-12809**  
363 pièces  
1 feuille d'autocollants  
1 notice de montage  
1 notice d'utilisation

### **Données techniques**

Date de fabrication (mois/année) : 06/2023

Delta-Sport Handelskontor GmbH déclare par la présente que cet article répond aux exigences essentielles et aux autres dispositions en vigueur suivantes : 2009/48/CE – Directive relative à la sécurité des jouets

UK CA UK Conformity Assessed  
Cat article est un jouet pour enfants à partir de 5 ans destiné à un usage privé.

FR/BE

### **Zastosowanie zgodne z przeznaczeniem**

Ten produkt jest zabawką dla dzieci od 5. roku życia i jest przeznaczony do użytku prywatnego.

### **Wskazówki bezpieczeństwa**

- Ostrzeżenie. Nie nadaje się dla dzieci w wieku poniżej 36 miesięcy. Niebezpieczeństwo udławienia się. Małe kulki.
- Ostrzeżenie. Opakowanie oraz materiały mocujące nie są częścią zabawki i ze względów bezpieczeństwa muszą być zawsze usunięte, zanim artykuł będzie przekazany dzieckiemu do zabawy.

• Dzieci mogą bawić się artykułem tylko pod nadzorem osób dorosłych.

• Należy sprawdzić artykuł przed każdym użyciem pod względem uszkodzeń i zużycia. Artykuł może być używany tylko w nienagannym stanie!

### **Przechowywanie, czyszczenie**

Podczas nieużywania należy zawsze przechowywać produkt w suchym i czystym miejscu, w temperaturze pokojowej. Wycierać do czysta jedynie suchą szmatką.

### **WażNE!** Nie czyścić przy użyciu ostrych środków czyszczących.

### **Uwagi odnośnie recyklingu**

Artykuł i materiały opakowaniowe należy usunąć zgodnie z aktualnie obowiązującymi miejscowymi przepisami. Materiały opakowaniowe (np. worki foliowe) należy przechowywać w miejscu niedostępnym dla dzieci. Szczegółowe informacje na temat sposobów usuwania użytego artykułu można uzyskać u władz gminnych i miejskich. Artykuł oraz opakowanie należy usunąć w sposób przyjazny dla środowiska.

Kod recyklingu służy do oznaczenia różnych materiałów nadających się do ponownego przetworzenia (recyklingu). Kod taki składa się z symbolu recyklingu odzwierciedlającego obieg materiałów do ponownego przetworzenia, a także z numeru, który jest oznaczeniem materiału.

### **Wskazówki dotyczące gwarancji i obsługi serwisowej**

Artykuł został wyprodukowany z najwyższą starannością i pod stałą kontrolą DELTA-SPORT HANDELSKONTOR GmbH dla przynajmniej 3-letniej gwarancji (okres gwarancyjny) z zastrzeżeniem poniższych postanowień. Gwarancja dotyczy wyłącznie wad materiałowych i wad wykonania.

FR/BE

FR/BE

FR/BE

NL/BE

NL/BE

NL/BE

PL

PL





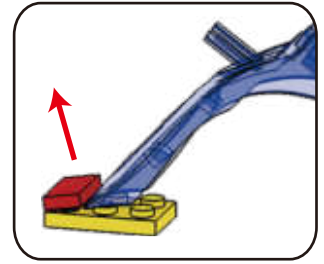
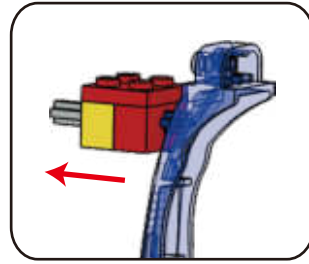
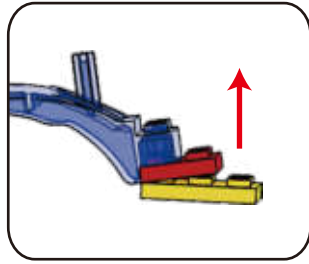
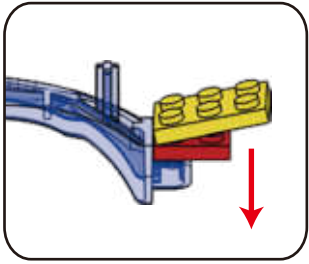

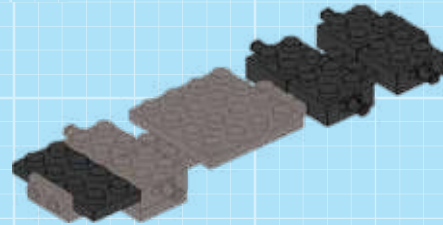
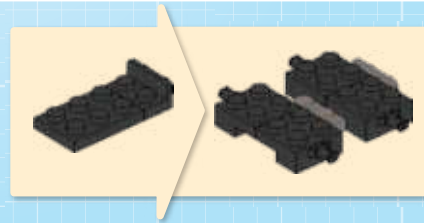
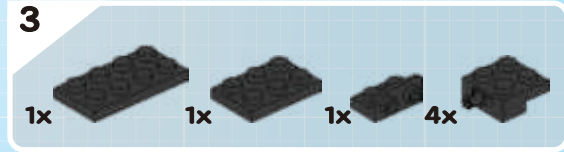
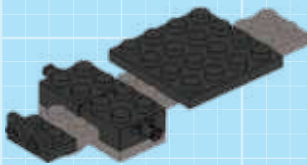
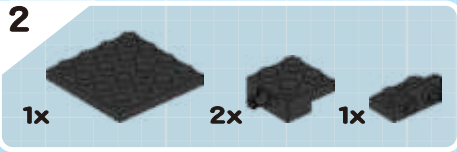
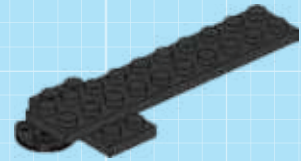
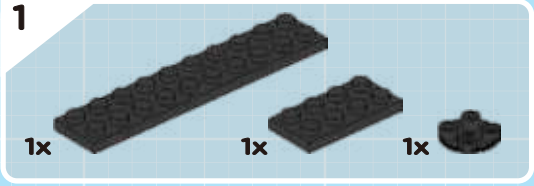

4

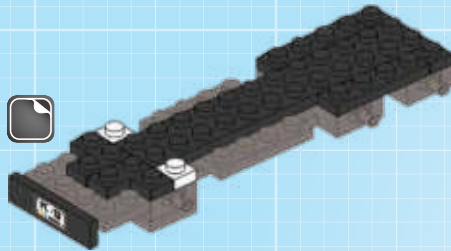
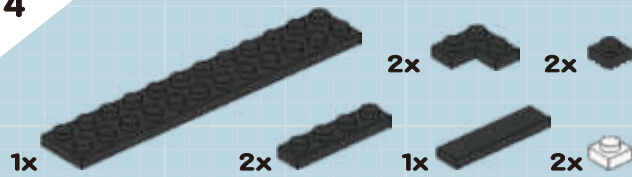

5

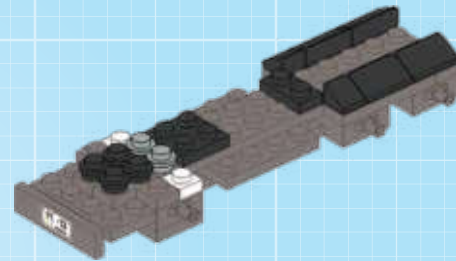

6

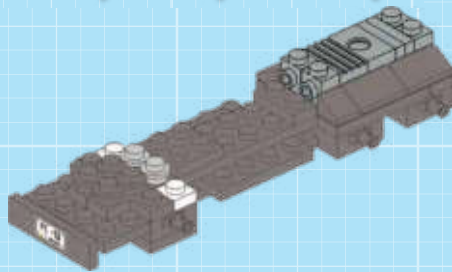
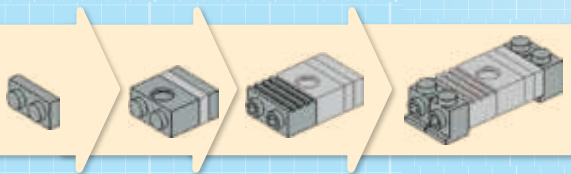

2

7

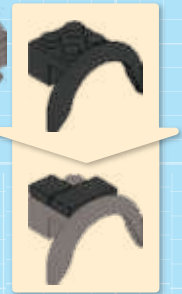
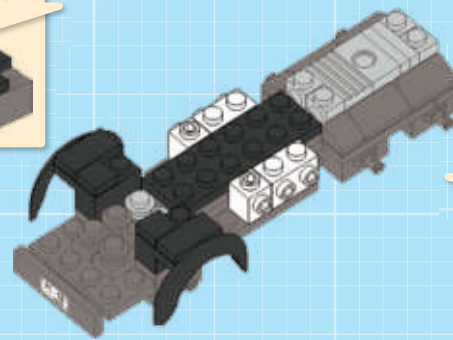

8

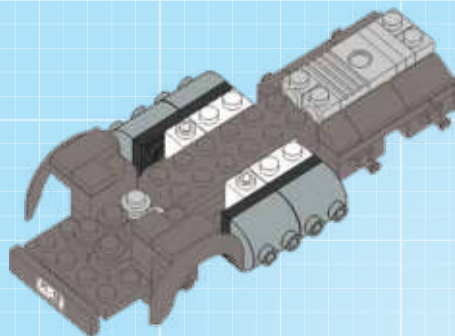
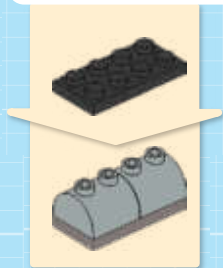
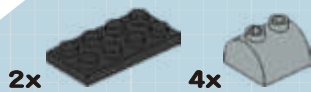

9

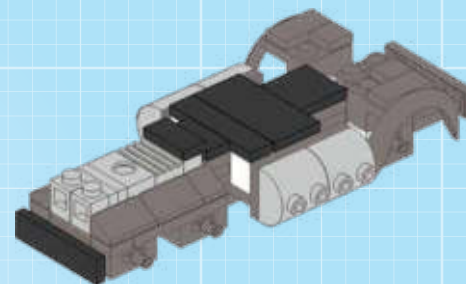
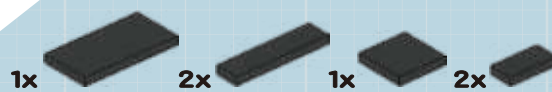

10

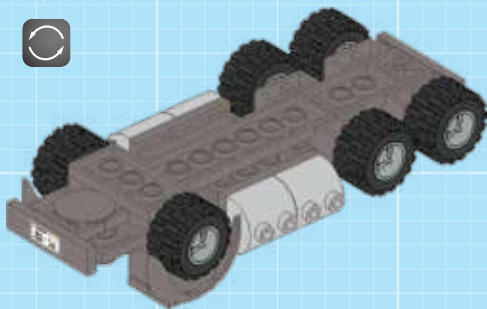

11



12

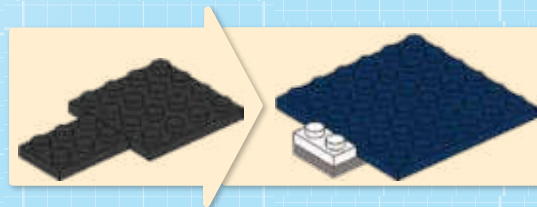
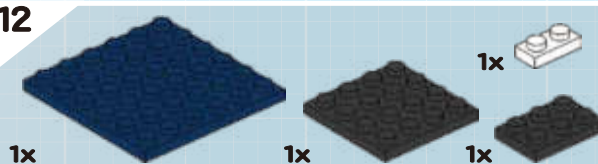

13

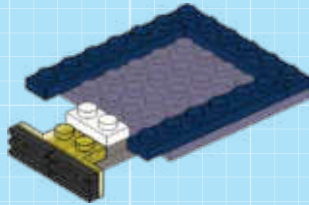
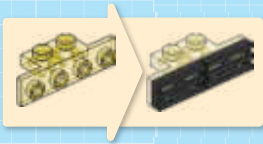
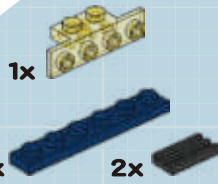

14

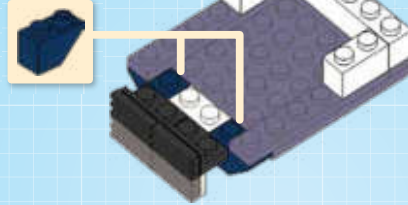
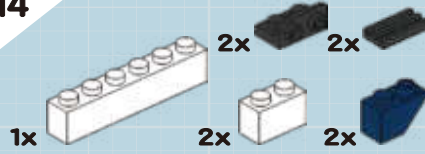

15

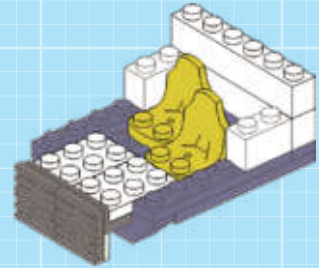
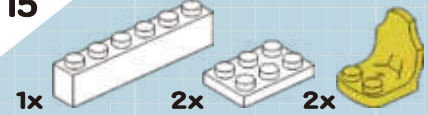

16

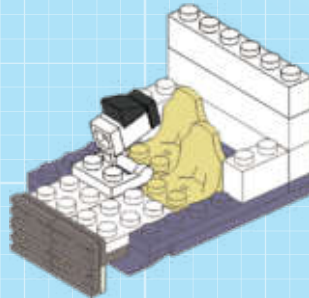

17





18

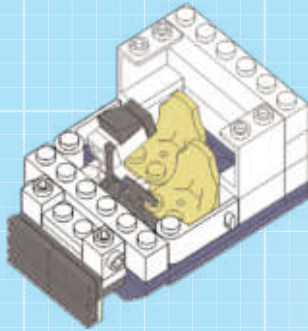
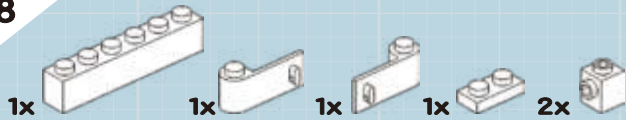

19

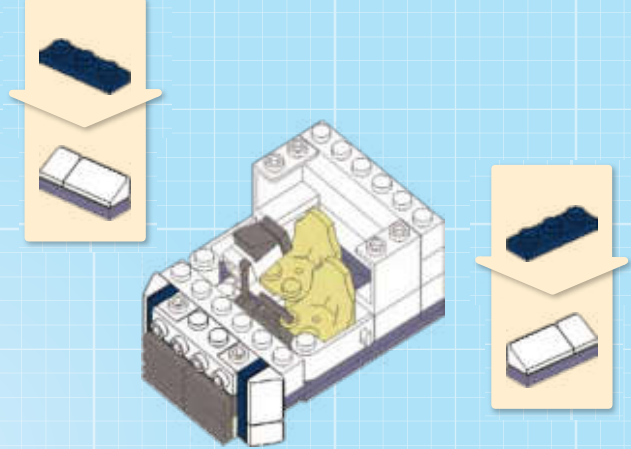
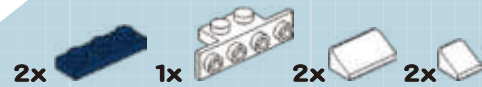

20

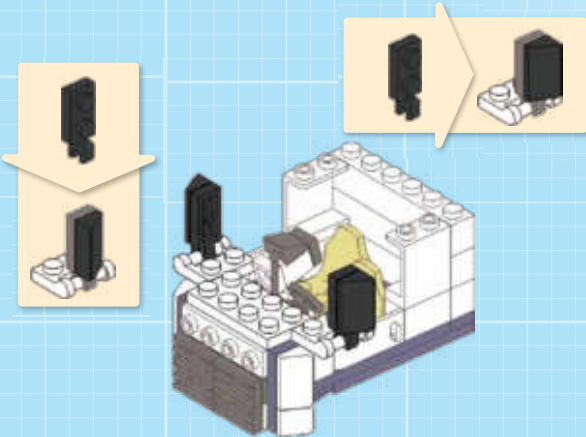

21

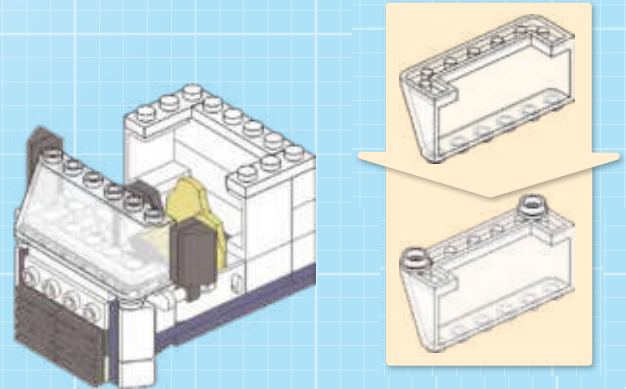
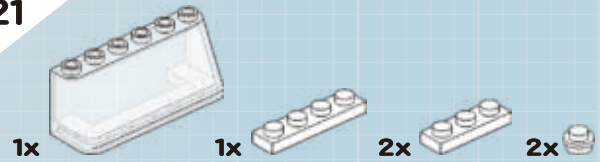

22

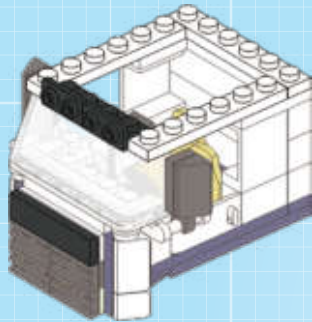

23

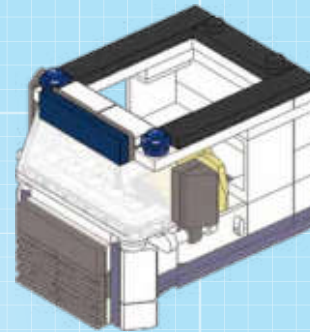

24

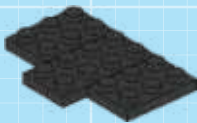
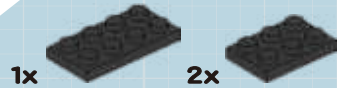

25



26

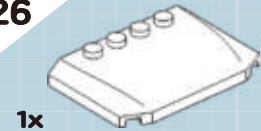

27

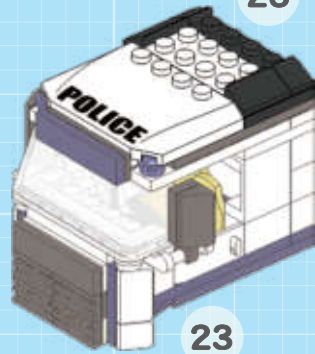

28

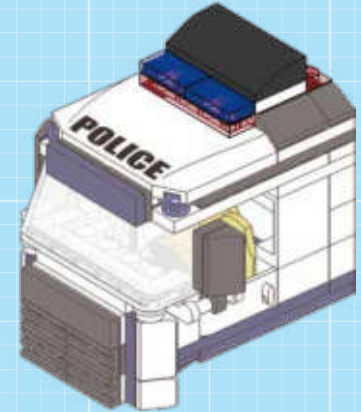
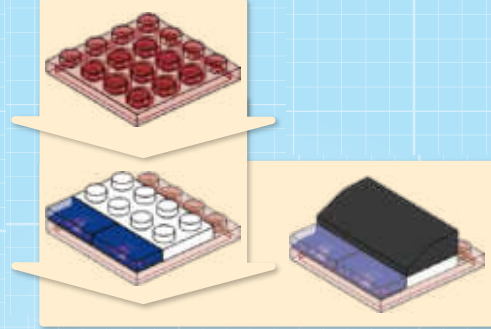

29

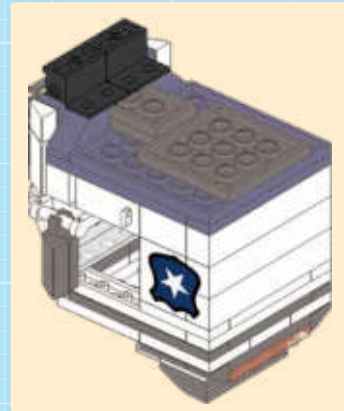
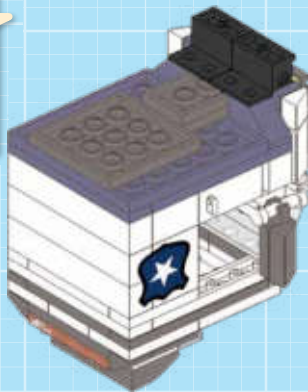

30

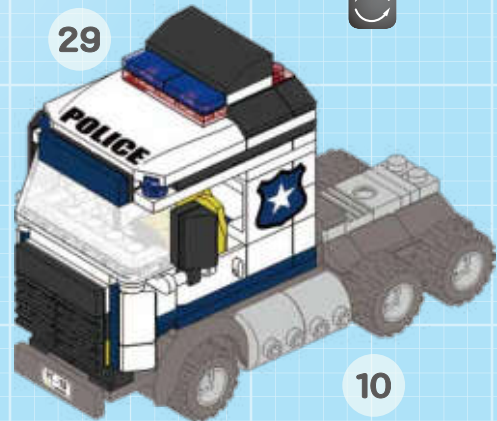

2



31

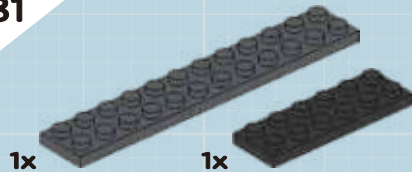

1x

1x

32

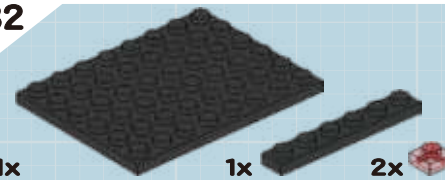

1x

1x

2x

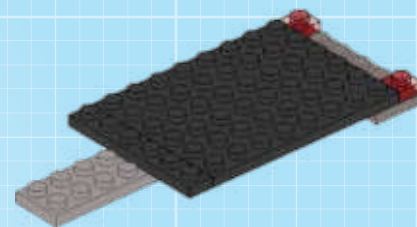
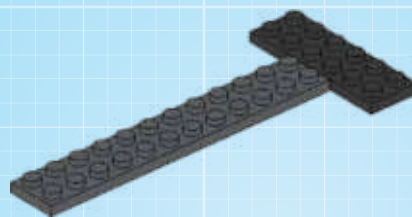

33

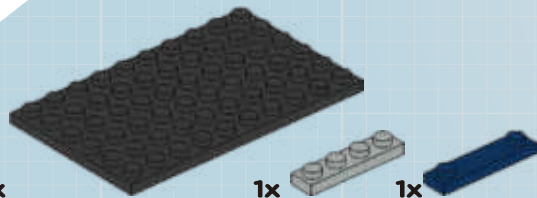

1x

1x

1x

34



1x

1x

1x

1x

1x

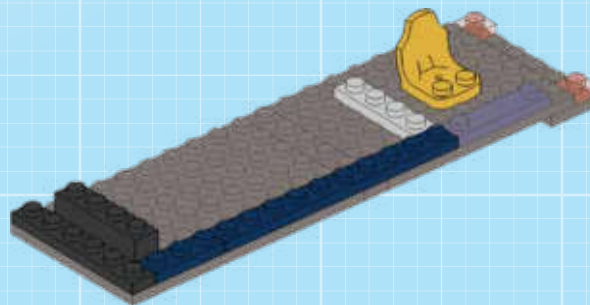
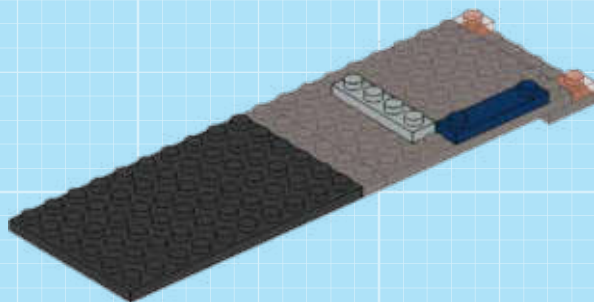

35

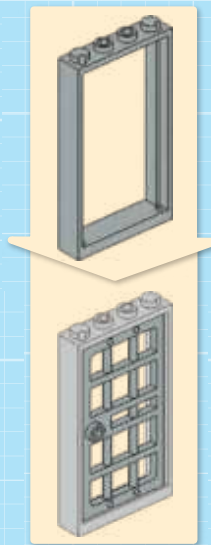
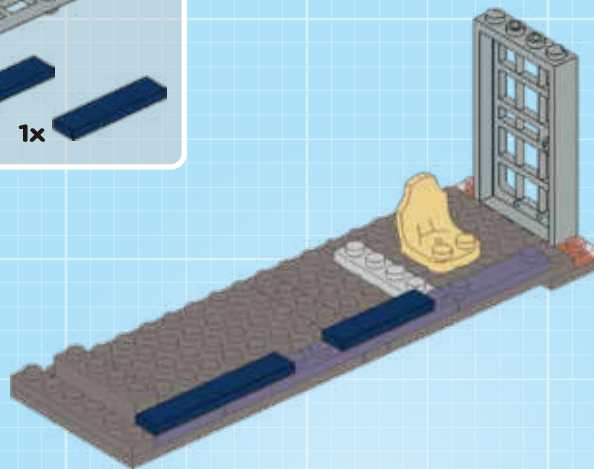
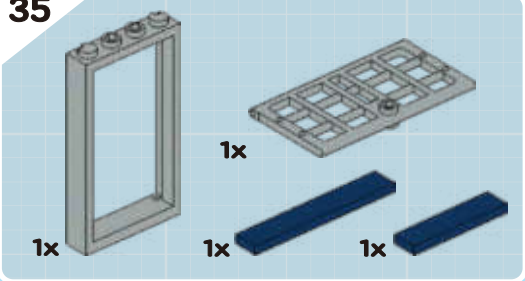

36

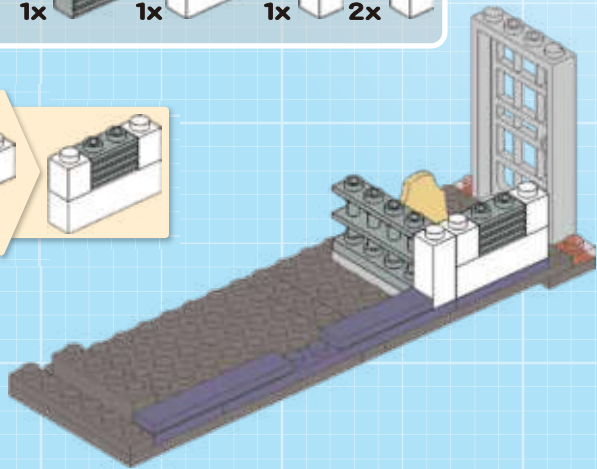
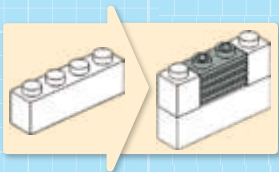
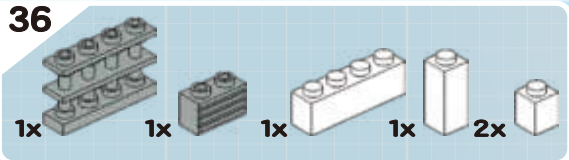

37

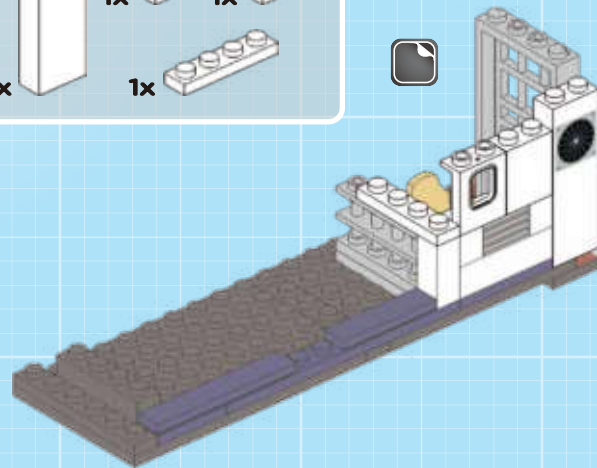
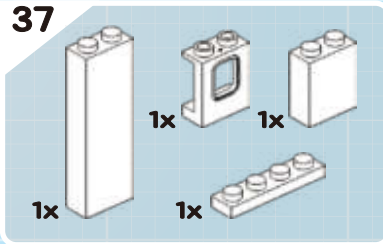

38

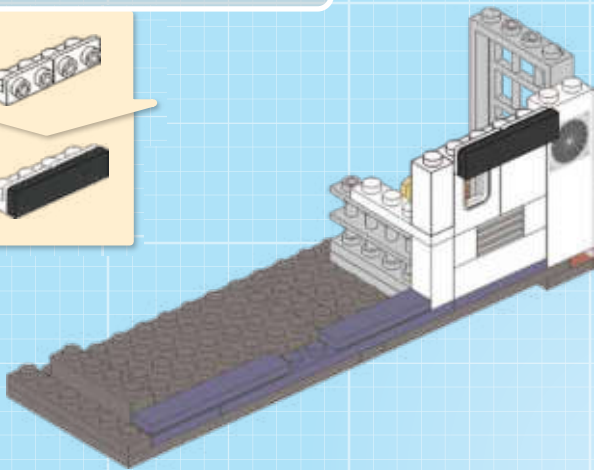
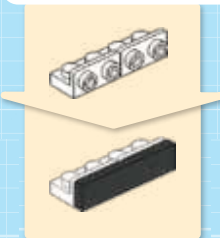
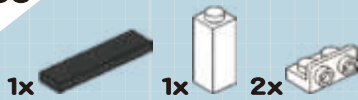

39

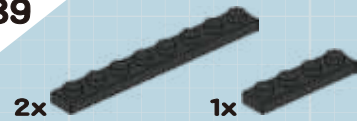

40

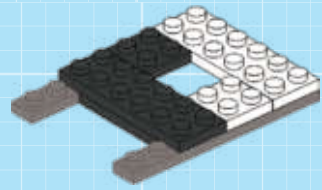
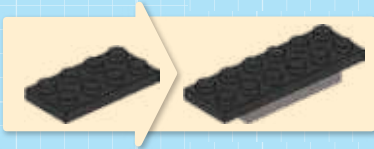
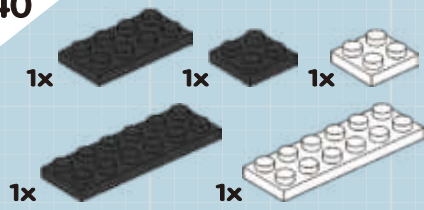

41

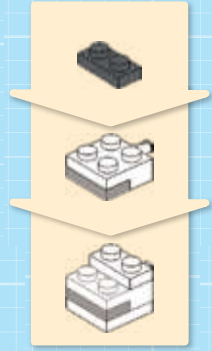
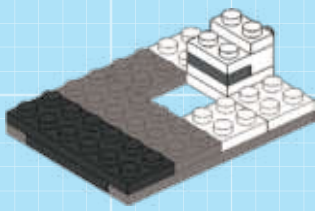

42

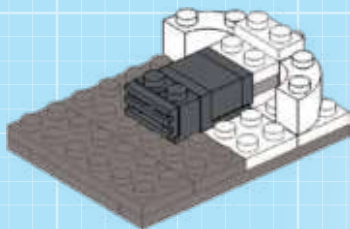
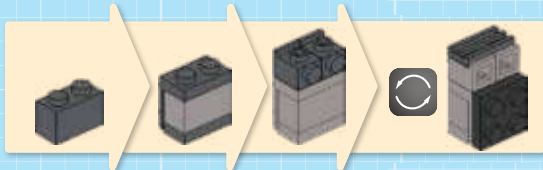

43

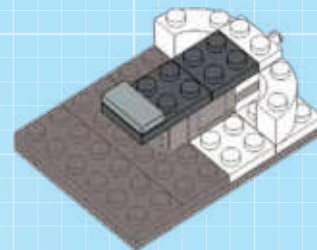
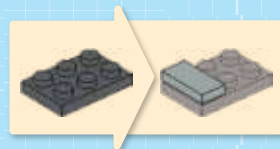

44

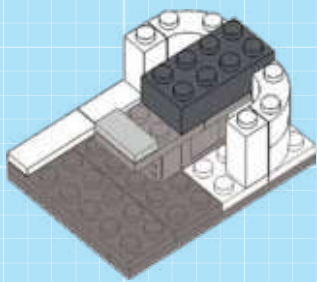
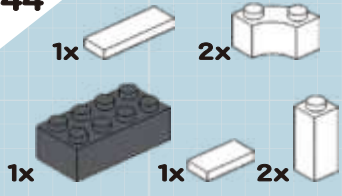

45

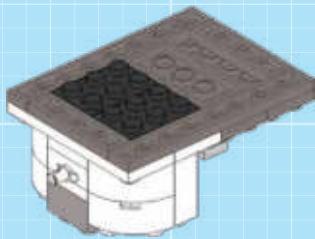

46

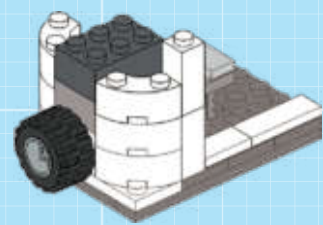
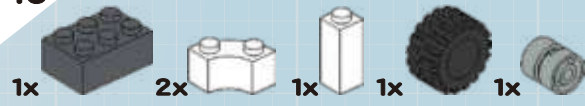

47

- 2x
- 2x
- 1x
- 1x
- 1x

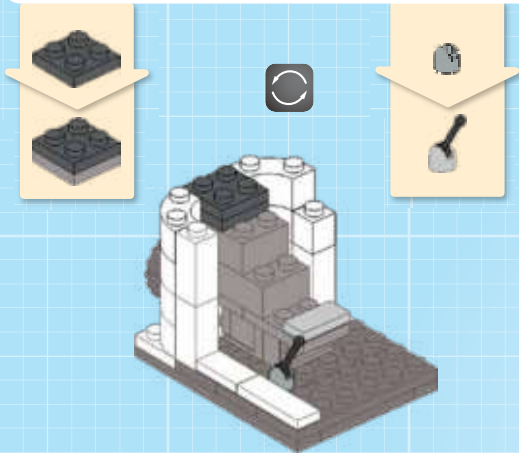

48

- 1x
- 1x
- 1x
- 1x
- 1x

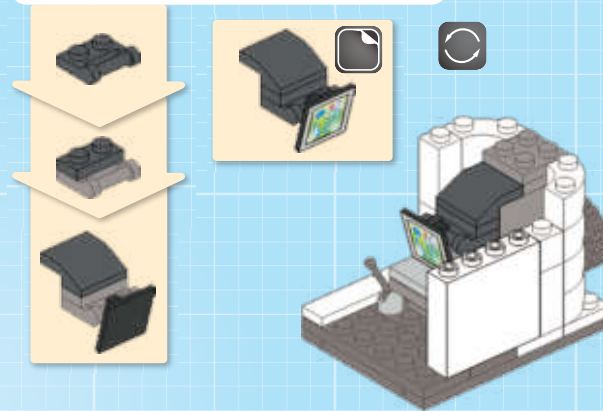

49

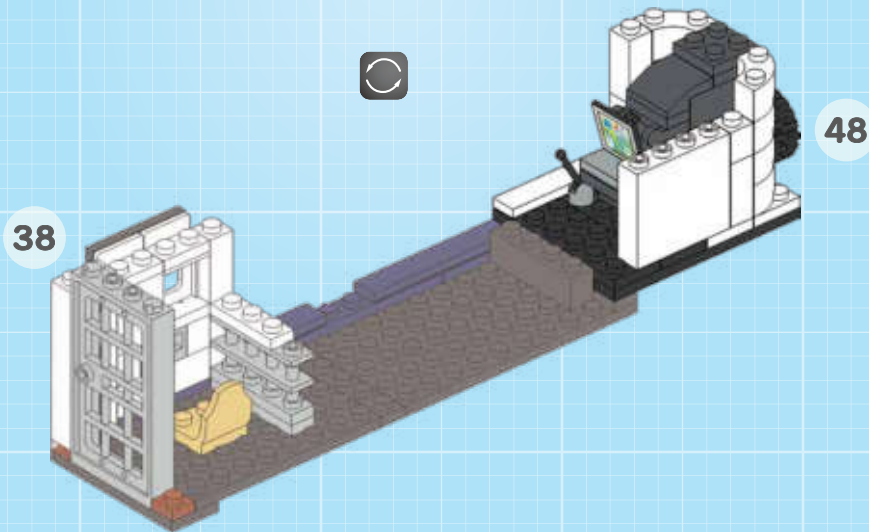



50

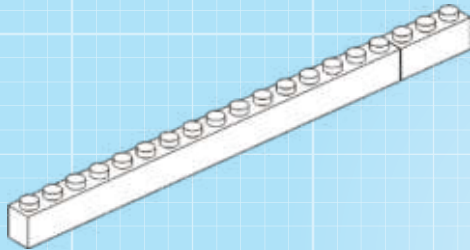
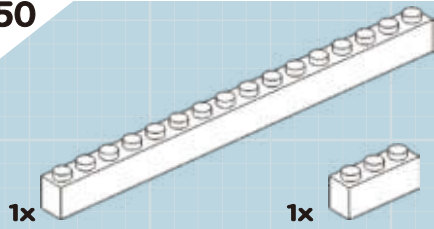

51

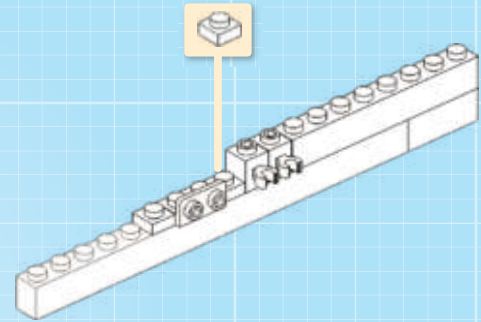
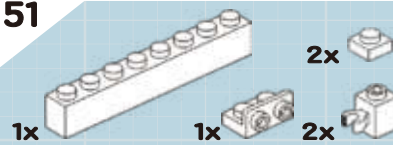

52

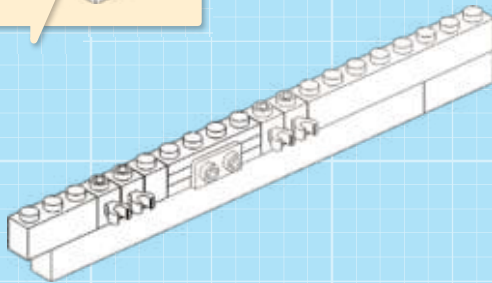
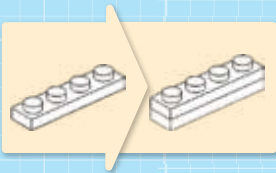
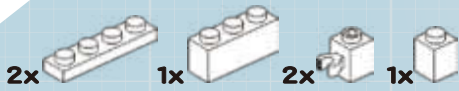

53

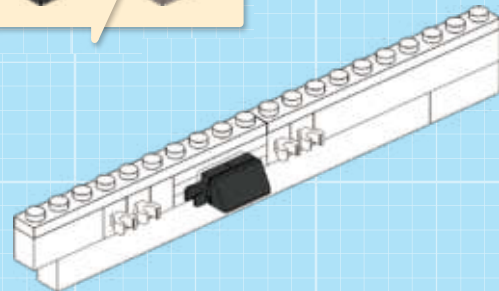
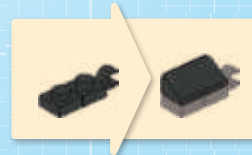
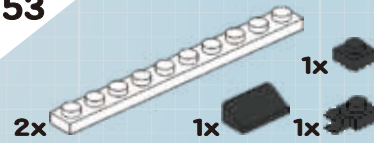

54

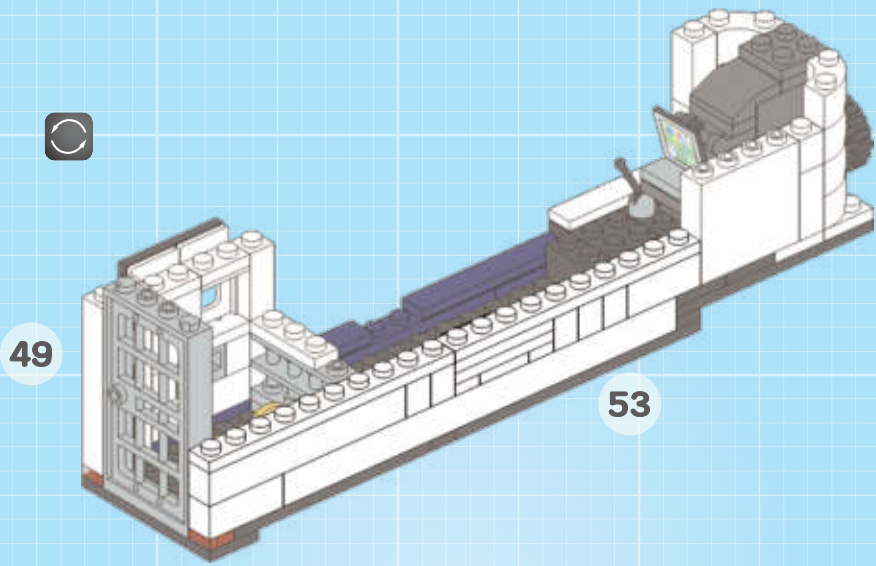

55

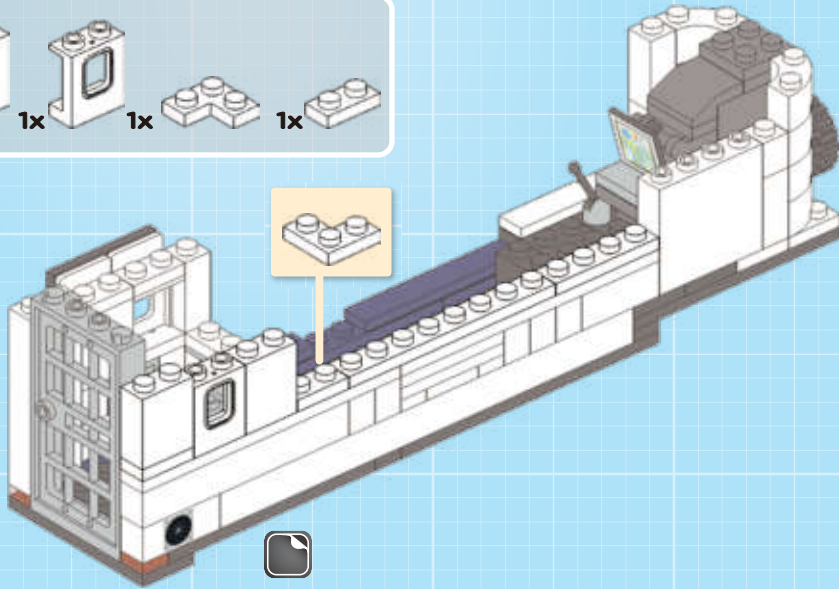
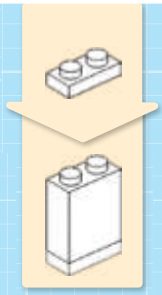
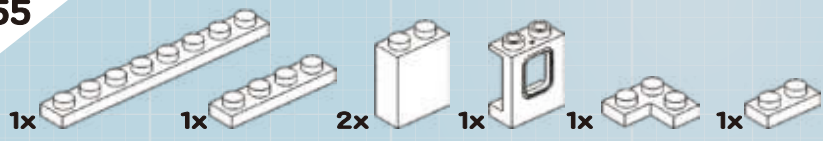

56

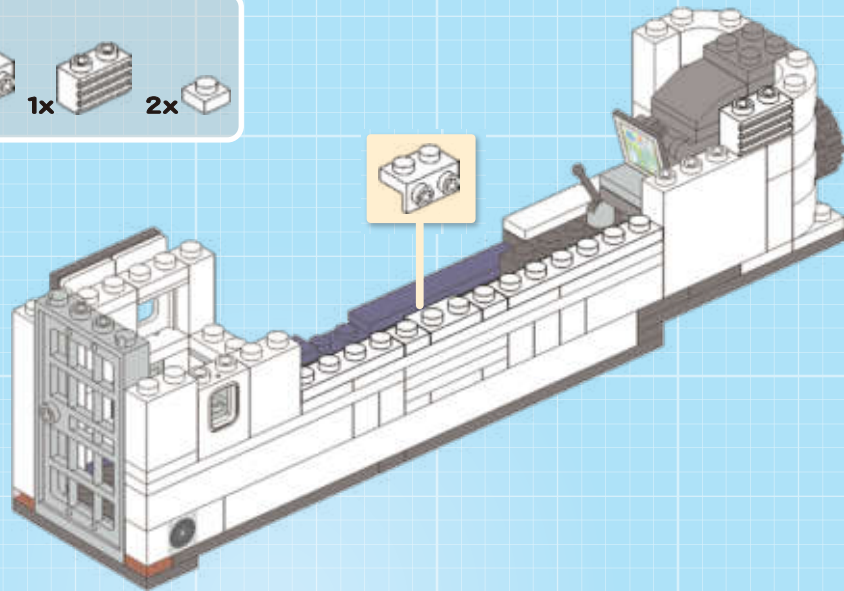
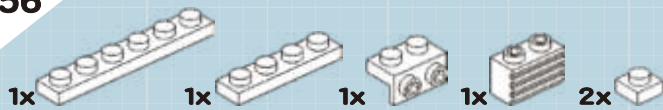

57

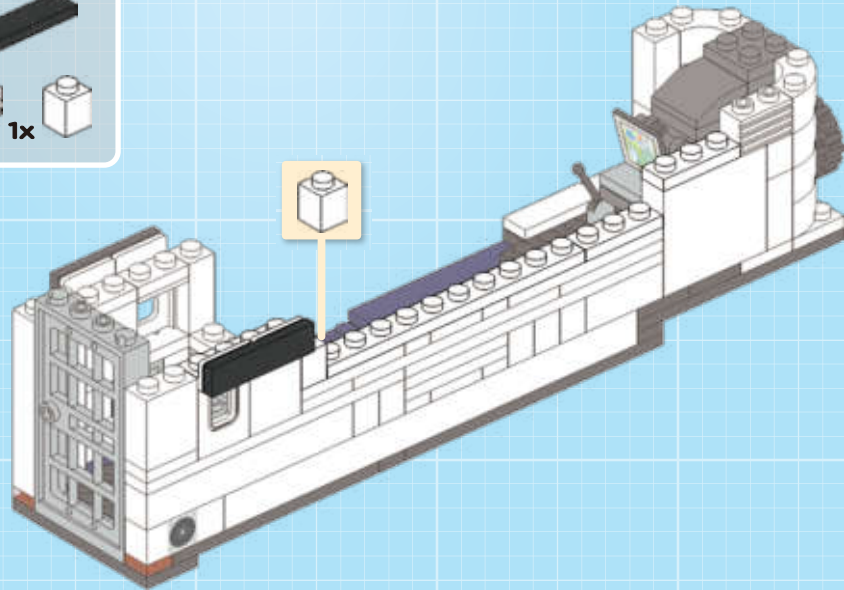
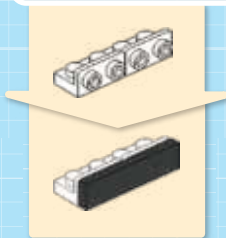
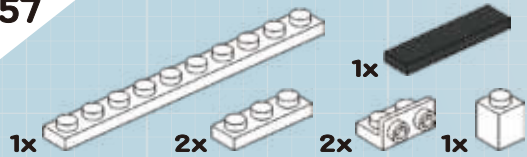

58

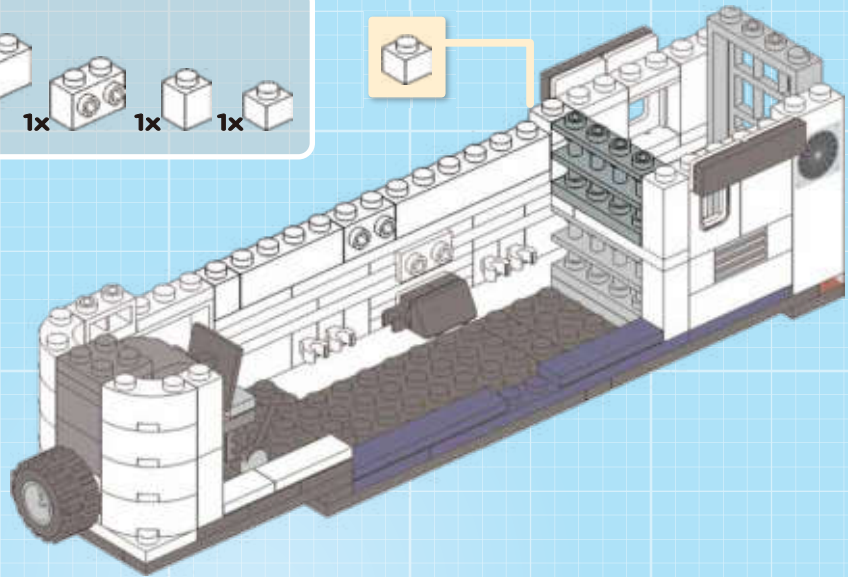
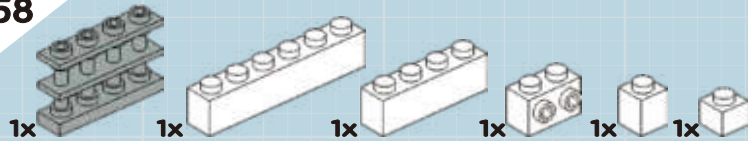

59

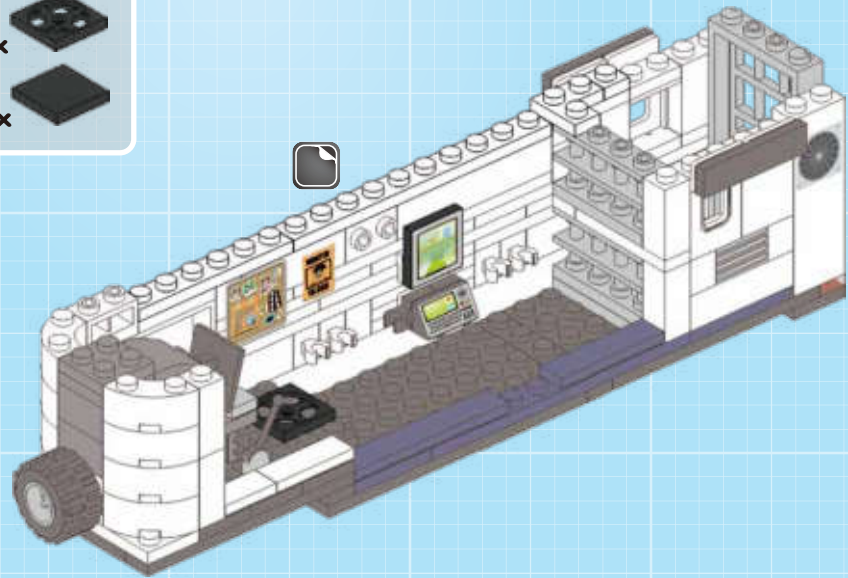
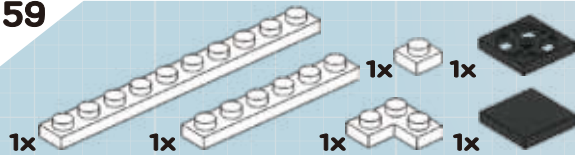

60

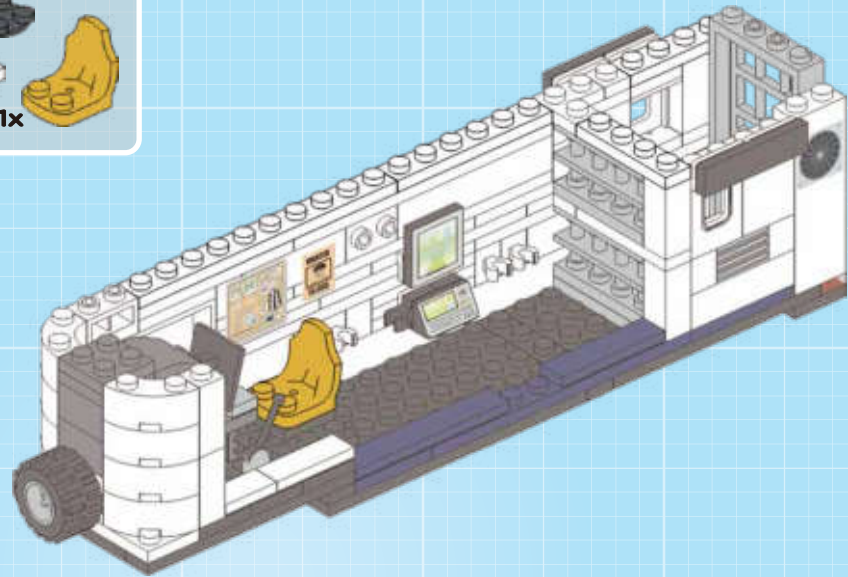
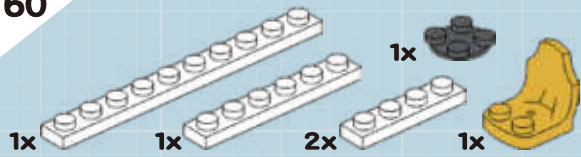

61

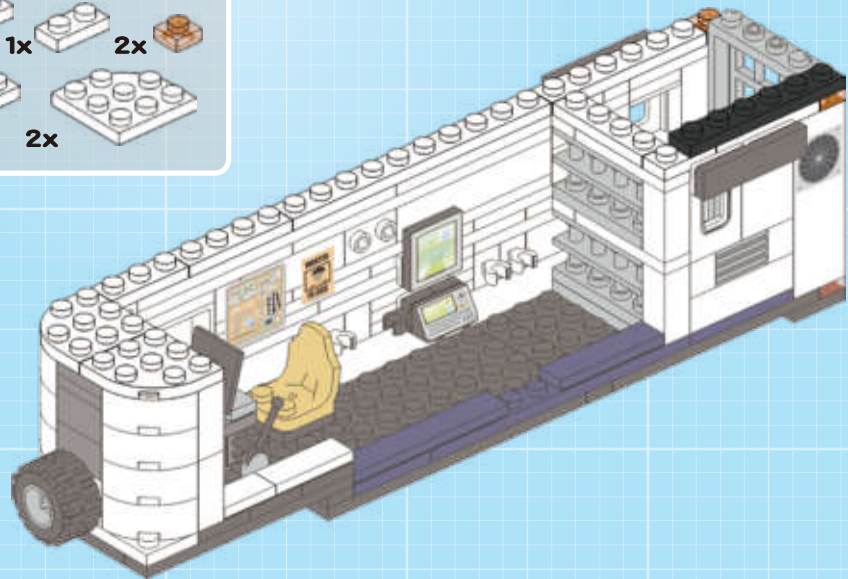
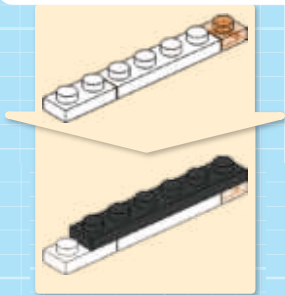
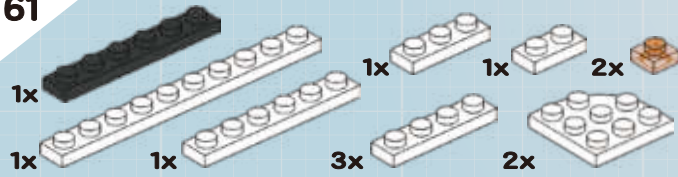

62

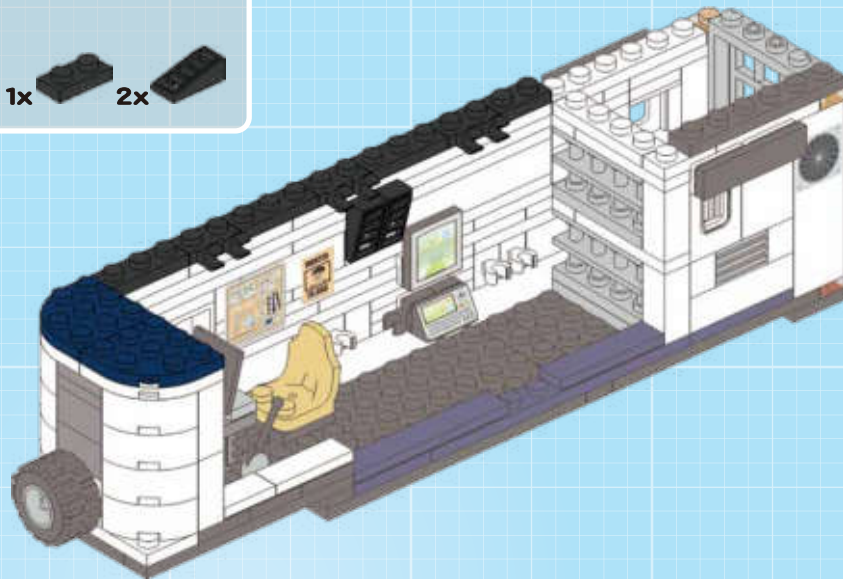
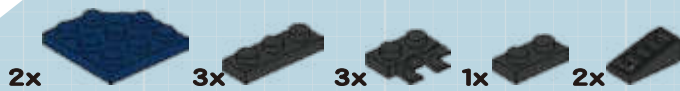

63

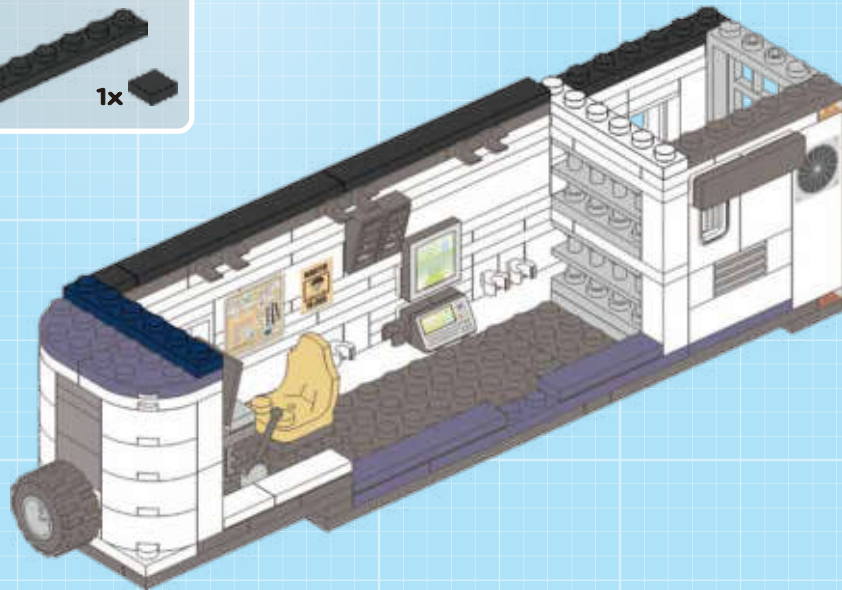
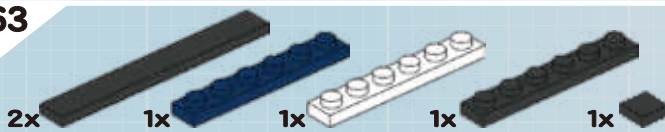

64

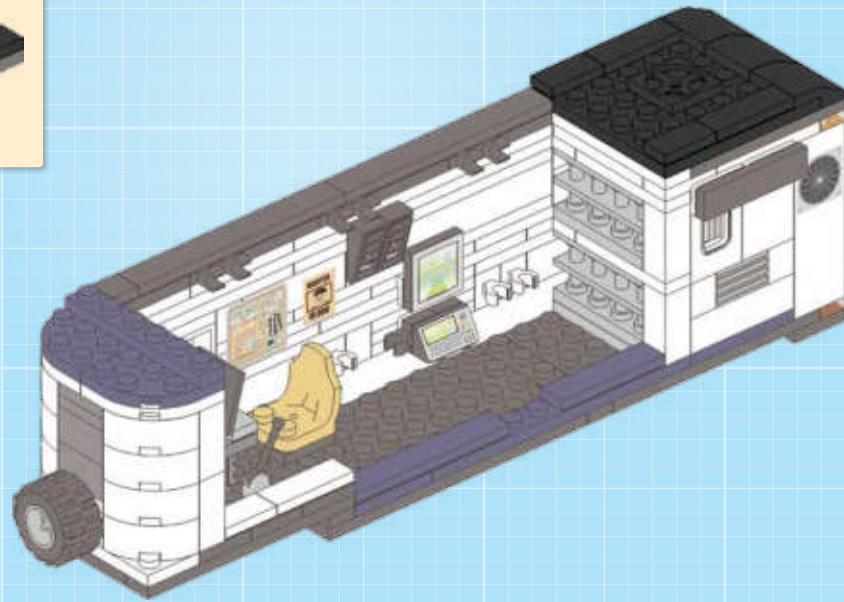
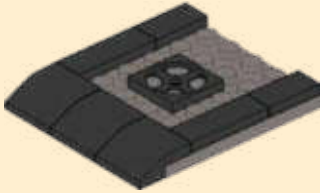
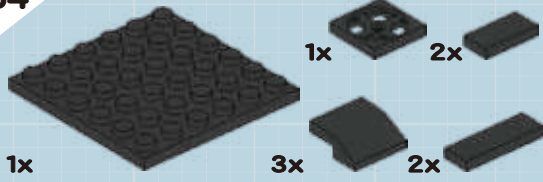

65

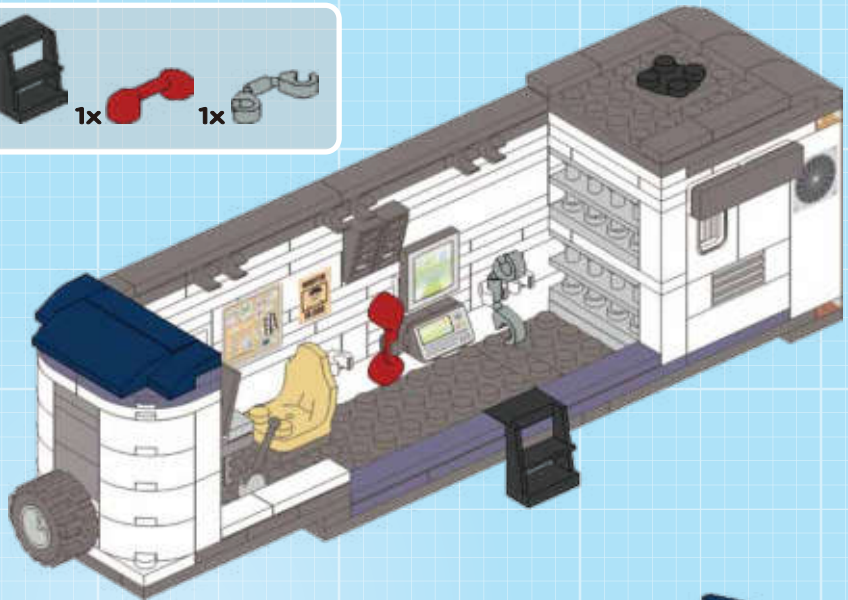

66

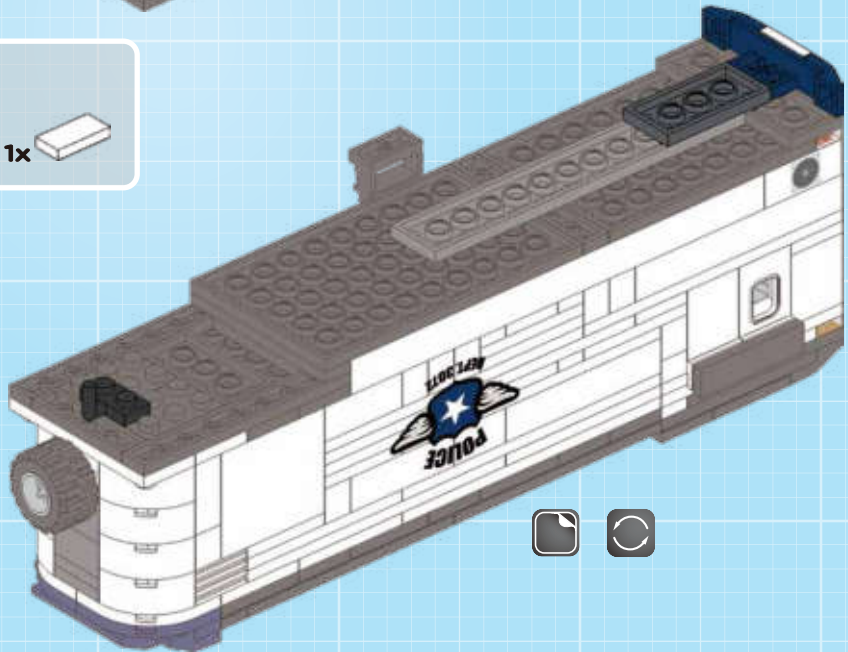
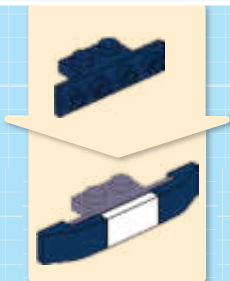
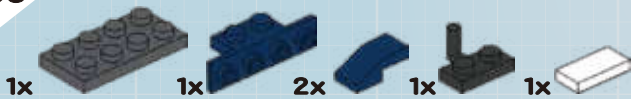



67

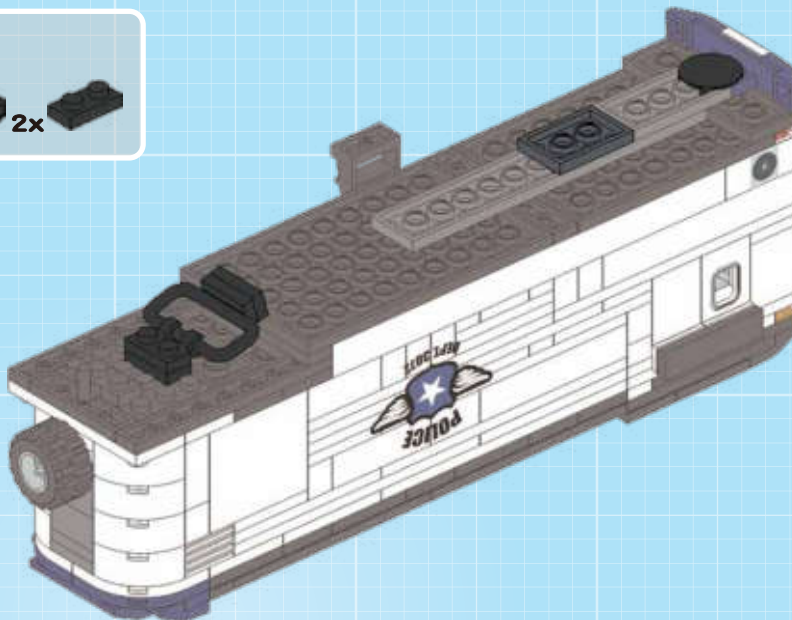
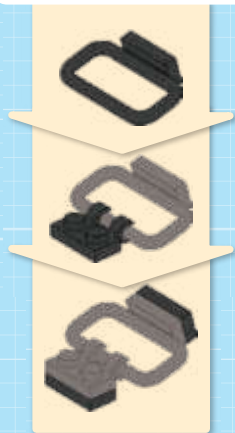

68



69



70

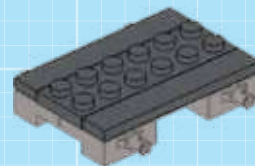
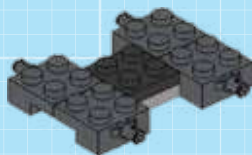
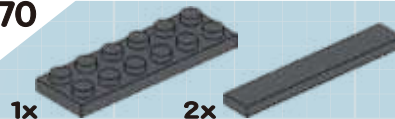

71

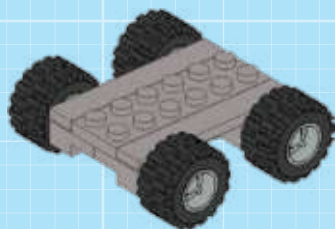

72



71

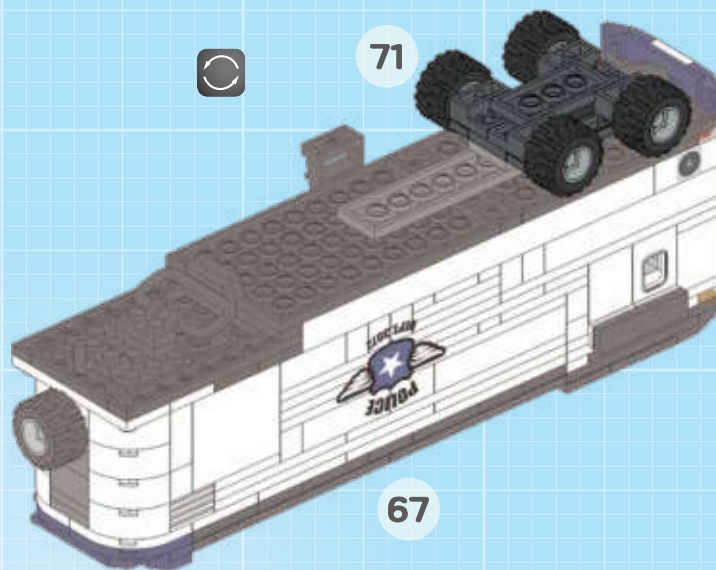

67

73

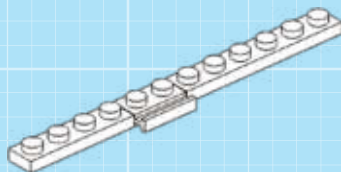
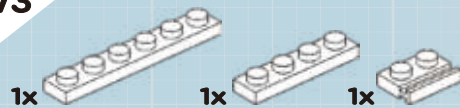

74

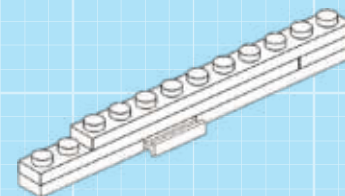
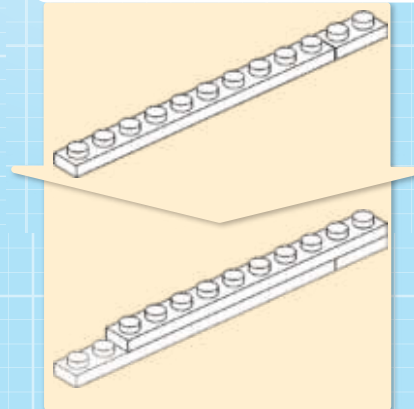
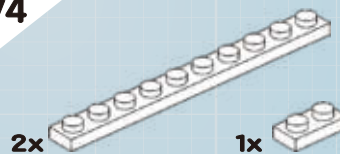

75

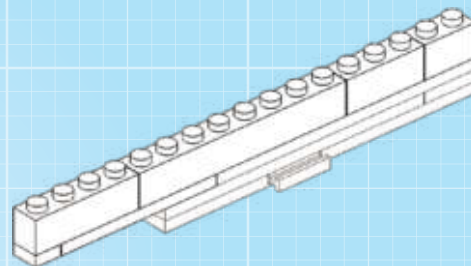
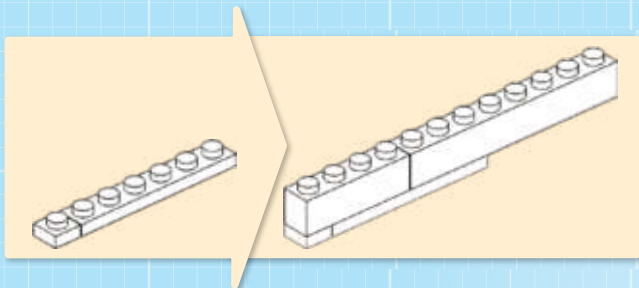
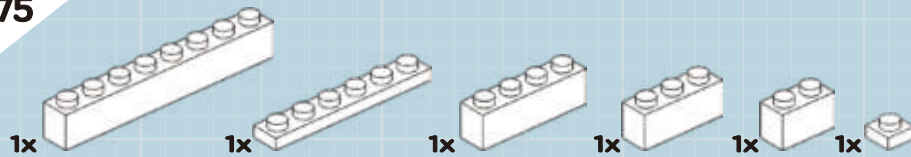

76

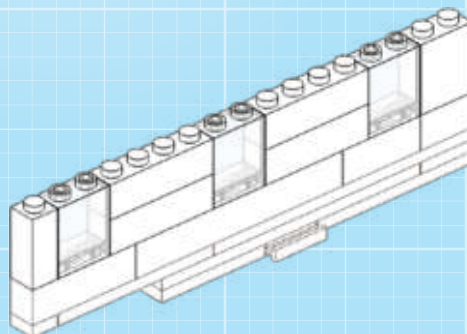
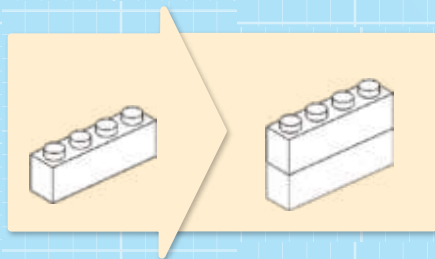
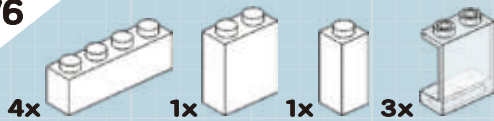

77

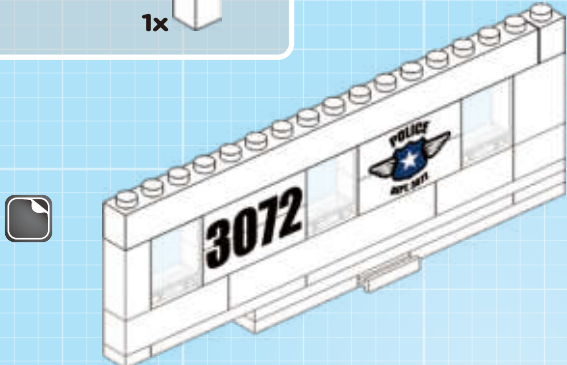
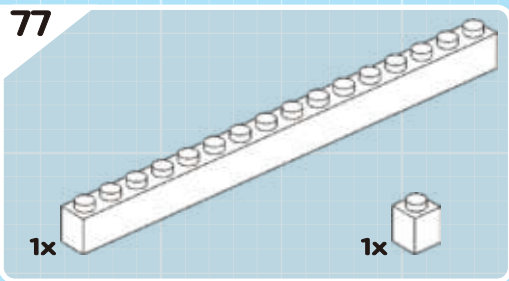

78

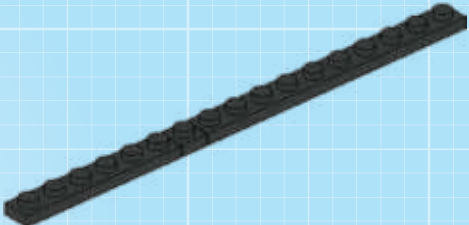
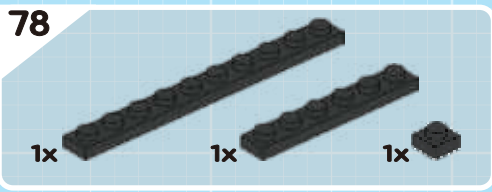

79

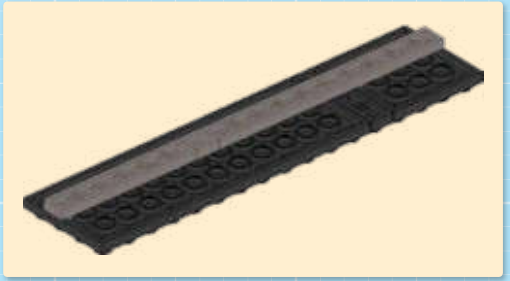
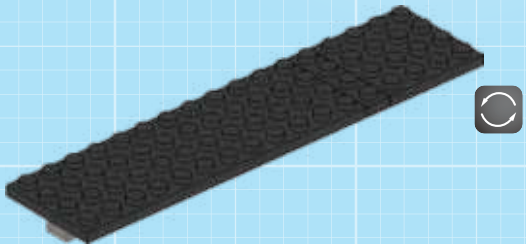
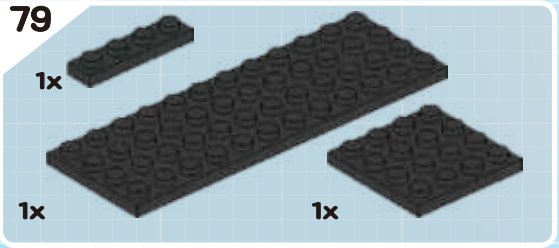

80

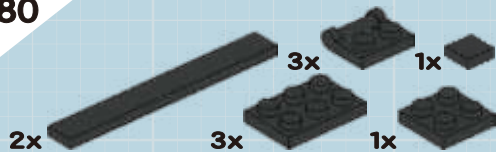

81

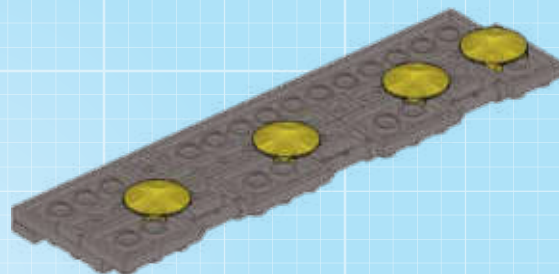
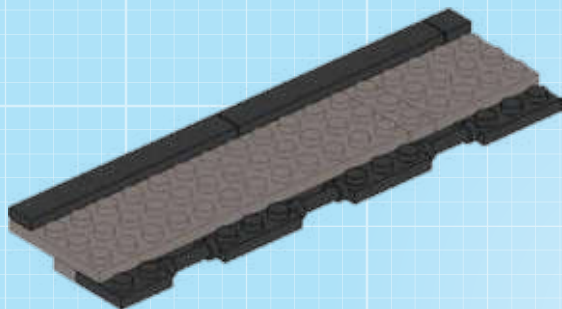

82

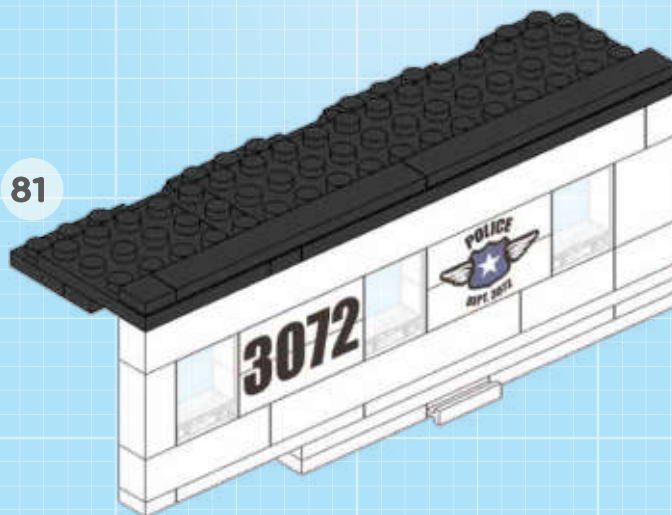

83



72

82

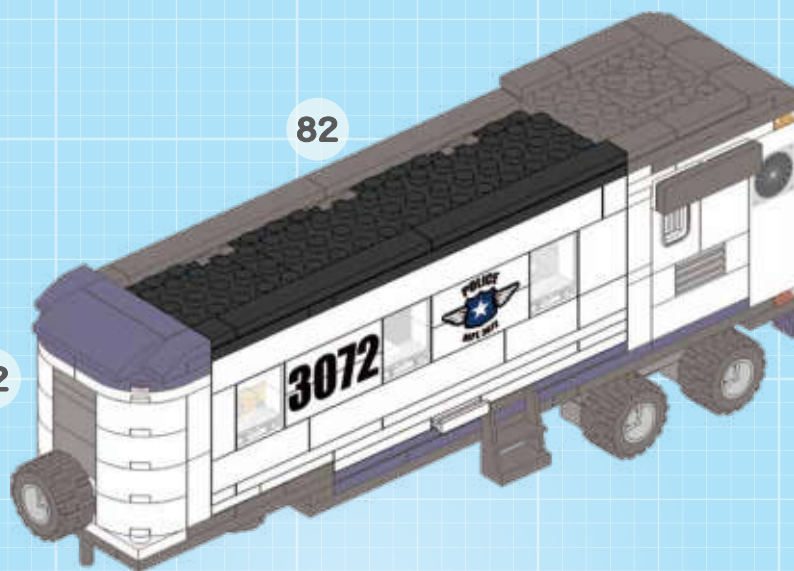

84

1x



1x



1x



1x

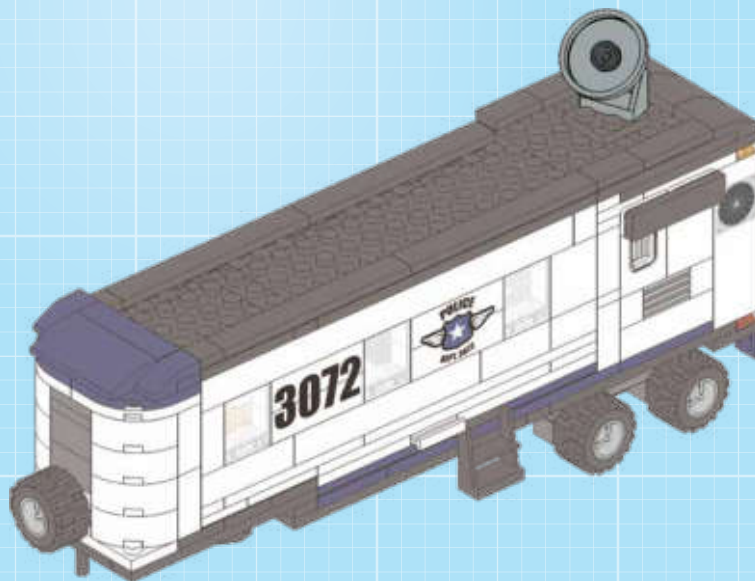
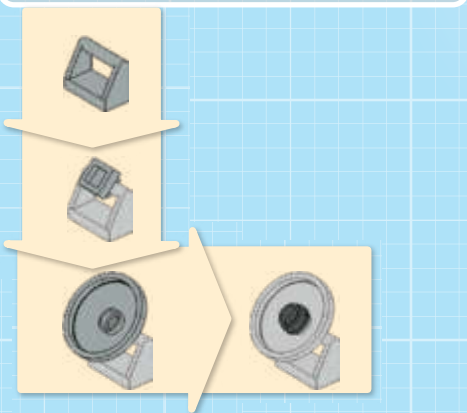

85

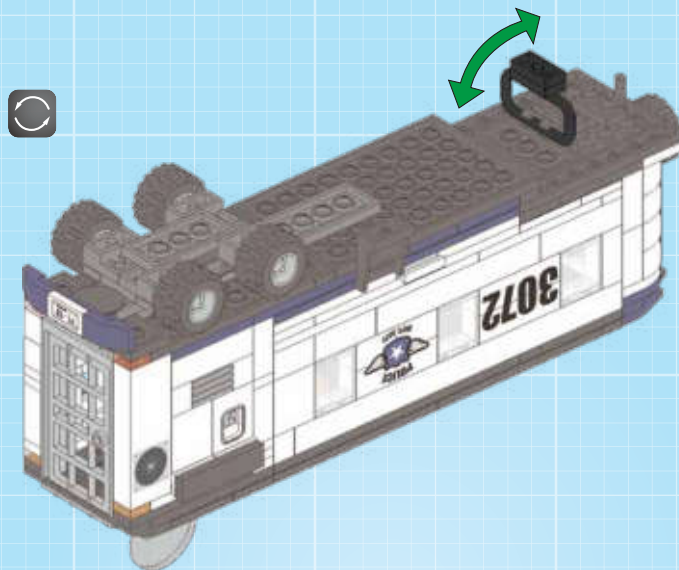

86

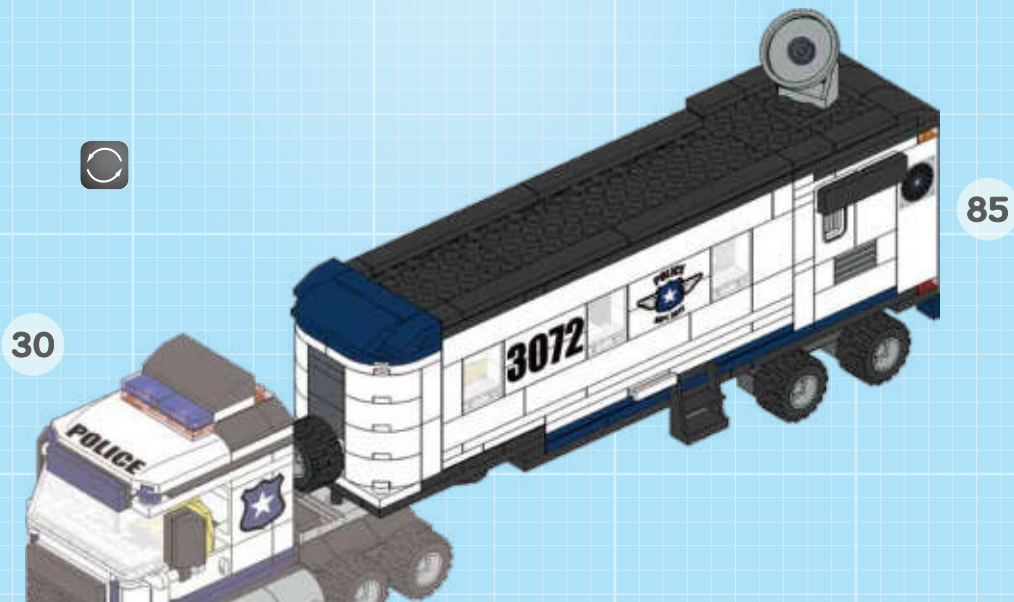



87



88



89

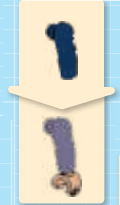
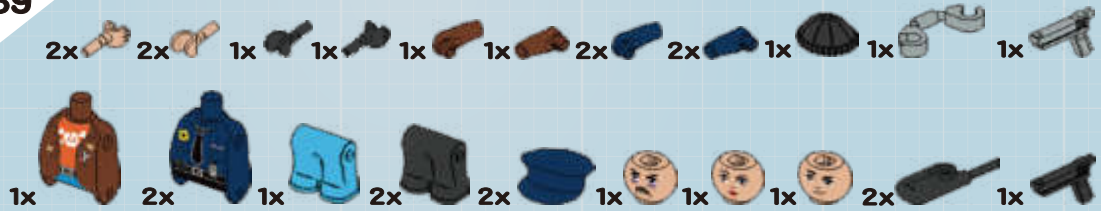



90

2x



2x



2x





1x



1x



1x



1x



1x



1x

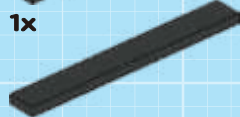

4x



1x



2x



4x



2x



5x



3x

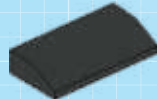

1x

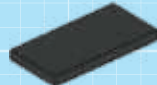

1x



7x



2x

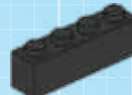

1x



1x



6x



6x



9x



3x



1x

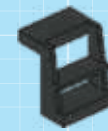

1x



1x



11x



2x



1x



6x

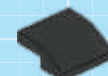

3x

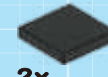

2x



2x

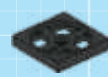

2x



2x



1x



2x



5x



6x



3x



2x



2x



1x



1x

- 2x
- 4x
- 4x
- 2x
- 6x
- 9x
- 4x
- 2x
- 2x
- 1x
- 1x
- 5x
- 5x

- 4x
- 4x
- 1x
- 2x
- 2x
- 2x
- 1x
- 1x
- 1x
- 1x
- 1x
- 1x
- 1x
- 1x
- 2x
- 2x

- 1x
- 3x
- 3x
- 1x
- 4x

- 1x
- 2x
- 2x
- 1x

- 1x
- 4x
- 1x
- 2x
- 1x
- 1x
- 3x
- 1x
- 3x

- 2x
- 4x
- 1x
- 1x
- 2x
- 1x
- 1x
- 1x
- 4x



1x



2x



2x



1x



2x



1x



2x



11x



1x



4x



1x



2x



1x



2x

2x

8x

2x

1x

5x

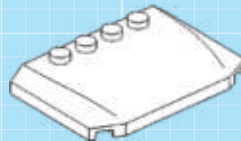
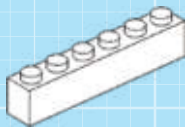
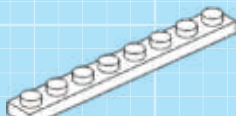
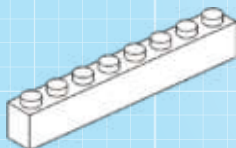
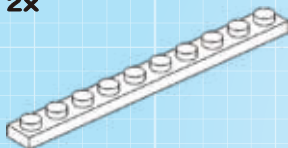
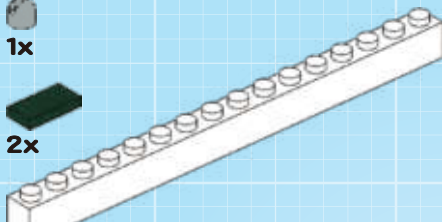

1x



1x

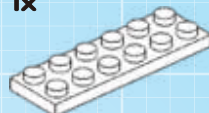

1x



10x

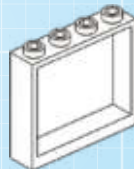

1x

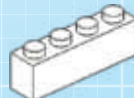

7x



3x



2x



12x



2x

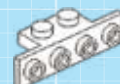

1x



1x

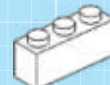

3x

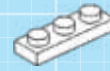

5x

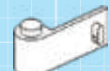

1x

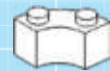

8x



2x



2x



2x



4x



1x



1x



2x



1x



3x



1x

