

POLICE TRUCK/ FIRE ENGINE/ EXCAVATOR/ JET ADVENTURE

GB IE NI

POLICE TRUCK/ FIRE ENGINE/ EXCAVATOR/ JET ADVENTURE

Instructions for use

DK

LEGETØJSSÆT "POLITILASTBIL"/ LEGETØJSSÆT "STIGEVOGN"/ GRAVKO/ EVENTYR JET

Brugervejledning

FR BE

CAMION DE POLICE/ CAMION DE POMPIERS AVEC ÉCHELLE/ PELLETEUSE/ JET FANTASTIQUE

Notice d'utilisation

NL BE

POLITIEVRACHTWAGEN/ BRANDWEER LADDERWAGEN/ GRAAFMACHINE/ ADVENTURE-JET

Gebruiksaanwijzing

DE AT CH

POLIZEITRUCK/ FEUERWEHR LEITERWAGEN/ BAGGER/ ABENTEUER JET

Gebrauchsanweisung



IAN 425746_2301



DELTA-SPORT HANDELSKONTOR GMBH
Wragekamp 6 • DE-22397 Hamburg
GERMANY

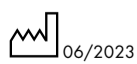

06/2023

Delta-Sport-Nr.: CL-12805, CL-12806, KB-11151, KB-11152

IAN 425746_2301



CL-12805

CL-12806

KB-11151

KB-11152

Congratulations!

You have chosen to purchase a high-quality product. Familiarise yourself with the product before using it for the first time.



Read the following instructions for use carefully.

Use the product only as described and only for the given areas of application. Store these instructions for use carefully. When passing the product on to third parties, please also hand over all accompanying documents.

Scope of delivery

CL-12805

- 489 x parts
- 1 x sticker sheet
- 1 x assembly instructions
- 1 x instructions for use

CL-12806

- 306 x parts
- 1 x sticker sheet
- 1 x assembly instructions
- 1 x instructions for use

KB-11151

- 275 x parts
- 1 x sticker sheet
- 1 x assembly instructions
- 1 x instructions for use

KB-11152

- 387 x parts
- 1 x sticker sheet
- 1 x assembly instructions
- 1 x instructions for use

Technical data



Date of manufacture (month/year): 06/2023



Delta-Sport Handelskontor GmbH hereby declares that this product meets the following basic requirements, as well as other important regulations:

2009/48/EC - Toy Safety Directive



UK Conformity Assessed
Delta-Sport Handelskontor GmbH hereby declares that this product meets the following basic requirements, as well as other important regulations:
Toys (Safety) Regulations 2011

Use according to guidelines

This product is a toy for children 5 years and up for private use.

Safety Instructions

- Warning. Not suitable for children under 36 months. Choking hazard. Small balls.
- Children may play with this article only under adult supervision.
- Warning. The packaging and mounting materials are not a constituent part of the toy and they must be removed in all cases for safety reasons before the product is given to children to play with.
- Check the product for damage and wear before each use. The product may only be used in good order and condition!

Storage, cleaning

When not in use, always store the product clean and dry at room temperature. Wipe clean with a dry cloth only. IMPORTANT! Never clean the product with harsh cleaning agents.

Disposal

Dispose of the product and packaging materials in accordance with current local regulations. Store the packaging materials (foil bags, for example) out of the reach of children. For further information about disposal of the product no longer needed, contact your local council. Dispose of the product and the packaging in an environmentally friendly manner.



The Recycling Code distinguishes different materials to be returned for recycling. The Code consists of the recycling symbol for the recycling process and a number that identifies the material.

Notes on the guarantee and service handling

The product was produced with great care and under continuous quality control. DELTA-SPORT HANDELSKONTOR GmbH gives private end customers a three-year guarantee on this product from the date of purchase (guarantee period) in accordance with the following provisions.

The guarantee is only valid for material and manufacturing defects. The guarantee does not cover parts subject to normal wear and tear that are thus considered wear parts (e.g. batteries) or fragile parts such as switches, rechargeable batteries, or parts made of glass.

GB/IE/NI

GB/IE/NI

GB/IE/NI

Sikkerhedsinformationer

- Advarsel. Ikke egnet for børn under 36 måneder. Kvælningssfare. Små dele.
- Børn må kun lege med legetøjet under opsyn af en voksen.
- Advarsel. Alle emballerings- og monteringsmaterialer er ikke en del af legetøjet, og skal af sikkerhedsgrunde altid fjernes, inden dukkehuset gives til børnene til at lege med.
- Kontroller artiklen for skader eller slid før hver brug. Artiklen må kun bruges i fejlfri tilstand!

Opbevaring, rengøring

Opbevar altid artiklen tør og ren ved stuetemperatur, når den ikke er i brug. Tør den kun af med en tør rengøringsklud. VIGTIGT! Må aldrig rengøres med skrappe rengøringsmidler.

Henvisninger vedr. bortskaffelse

Bortskaf artiklen og emballagematerialerne i henhold til aktuelle, lokale forskrifter. Opbevar emballagematerialer (som f.eks. folieposer) utilgængeligt for børn. Yderligere informationer om bortskaffelse af den udjente artikel kan indhentes hos kommunen. Bortskaf artiklen og emballagen på en miljøvenlig måde.

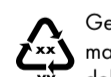

Genbrugskoden tjener til identifikation af forskellige materialer med hensyn til tilbageførsel til genanvendelses kredsløbet (recycling). Koden består af et genbrugssymbol, som afspejler genanvendelses kredsløbet, og et tal, der identificerer materialet.

Oplysninger om garanti og servicehåndtering

Varen er fremstillet med største omhu og under løbende kontrol. DELTA-SPORT HANDELSKONTOR GmbH yder private slutkunder tre års garanti på varen fra købsdato (Garantifrist) i henhold til følgende bestemmelser. Garantien gælder kun for materiale- og fremstillingsfejl. Garantien omfatter ikke dele, der er udsat for normal slid og derfor skal betragtes som sliddele (f.eks. batterier) og ikke skrøbelige dele, f.eks. kontakter, genopladelige batterier eller dele, der er fremstillet af glas.

Garantien kan ikke gøres gældende, hvis varen er blevet anvendt ukorrekt eller uagtsomt eller til andre formål end det tilsigtede eller i det tilsigtede omfang. Garantien bortfalder ligeledes ved manglende overholdelse af anvisningerne i betjeningsvejledningen. Kunden skal kunne påvise, at der er tale om materiale- eller fremstillingsfejl og ikke fejl som følge af ovenstående omstændigheder.

Garantien kan kun gøres gældende i garantiperioden mod fremvisning af original kvittering. Gem derfor den originale kvittering. Garantiperioden forlænges ikke i tilfælde af reparation i henhold til garantien, den lovpligtige garanti eller pr. kulance. Dette gælder også for udskiftede og reparerede dele.

I tilfælde af klager er det muligt at kontakte nedenstående servicelinje eller kontakte os pr. e-mail. Ved garantisager vil vi efter eget skøn reparere varen uden beregning, ombytte varen eller refundere købsprisen. Der er ingen yderligere rettigheder under garantien.

Dine lovmæssige rettigheder, herunder navnlig garanti-krav over for sælger, indskrænkes ikke som følge af denne garanti.

IAN: 425746_2301

DK Service Danmark
Tel.: 32 710005
E-Mail: deltasport@lidl.dk

Claims under this guarantee are excluded if the product has been used incorrectly, improperly, or contrary to the intended purpose, or if the provisions in the instructions for use were not observed, unless the end customer proves that a material or manufacturing defect exists that was not caused by one of the aforementioned circumstances.

Claims under the guarantee can only be made within the guarantee period by presenting the original sales receipt. Please therefore keep the original sales receipt.

The guarantee period is not extended by any repairs carried out under the guarantee, under statutory guarantees, or as a gesture of goodwill. This also applies to replaced and repaired parts.

If you wish to make a claim please first contact the service hotline mentioned below or contact us by e-mail. If there is a guarantee case, then the product will be repaired or replaced free of charge to you or the purchase price will be refunded, depending on our choice.

Your legal rights, in particular guarantee claims against the respective seller, are not limited by this guarantee.

IAN: 425746_2301

GB Service Great Britain
Tel.: 0800 404 7657
E-Mail: deltasport@lidl.co.uk

IE Service Ireland
NI Tel.: 1800 101010
E-Mail: deltasport@lidl.ie

Félicitations !

Vous venez d'acquiescer un article de grande qualité. Avant la première utilisation, familiarisez-vous avec l'article.

Pour cela, veuillez lire attentivement la notice d'utilisation suivante.

Utilisez l'article uniquement comme indiqué et pour les domaines d'utilisation mentionnés. Conservez bien cette notice d'utilisation. Si vous cédez l'article à un tiers, veuillez à lui remettre l'ensemble de la documentation.

Contenu de la livraison

CL-12805

- 489 pièces
- 1 feuille d'autocollants
- 1 notice de montage
- 1 notice d'utilisation

CL-12806

- 306 pièces
- 1 feuille d'autocollants
- 1 notice de montage
- 1 notice d'utilisation

KB-11151

- 275 pièces
- 1 feuille d'autocollants
- 1 notice de montage
- 1 notice d'utilisation

KB-11152

- 387 pièces
- 1 feuille d'autocollants
- 1 notice de montage
- 1 notice d'utilisation

Données techniques



Date de fabrication (mois/année) : 06/2023



Delta-Sport Handelskontor GmbH déclare par la présente que cet article répond aux exigences essentielles et aux autres dispositions en vigueur suivantes :

2009/48/CE – Directive relative à la sécurité des jouets

Utilisation conforme

Cet article est un jouet pour enfants à partir de 5 ans destiné à un usage privé.

⚠ Instructions de sécurité

- Attention. Ne convient pas aux enfants de moins de 36 mois. Danger d’étouffement. Petites balles.
- Les enfants ne doivent jouer avec l’article que sous la surveillance d’adultes.
- Attention. Les matériaux d’emballage et de fixation ne font pas partie du jouet et doivent toujours être enlevés pour des raisons de sécurité avant que le produit ne soit remis aux enfants pour jouer.
- Avant la première utilisation, veuillez vérifier que l’article ne présente aucun dommage ni signe d’usure. L’article ne doit être utilisé que dans un parfait état !

Stockage, nettoyage

Lorsque vous n’utilisez pas l’article, rangez-le toujours dans un endroit sec et propre à une température ambiante. Essayez uniquement avec un chiffon de nettoyage à sec. **IMPORTANT !** Ne jamais laver avec des produits de nettoyage agressifs.

Mise au rebut

Ce produit est recyclable. Il est soumis à la responsabilité élargie du fabricant et est collecté séparément.

Éliminez le produit et les matériaux d’emballage conformément aux réglementations locales actuelles en vigueur. Conservez les matériaux d’emballage (comme les sachets en plastique) hors de portée des enfants. Vous obtiendrez plus d’informations relatives à l’élimination du produit usagé auprès de votre commune ou de votre municipalité. Éliminez le produit et l’emballage dans le respect de l’environnement.

Le code de recyclage est utilisé pour identifier les différents matériaux à retourner dans le cycle de recyclage. Ce code se compose du symbole de recyclage, représentant le cycle de recyclage ainsi que d’un numéro identifiant le matériau.

Indications concernant la garantie et le service après-vente

L’article a été produit avec grand soin et sous un contrôle constant. DELTA-SPORT HANDELSKONTOR GmbH accorde au client final privé une garantie de trois ans sur cet article à compter de la date d’achat (période de garantie) conformément aux dispositions suivantes. La garantie ne vaut que pour les défauts de matériaux et de fabrication.

La garantie ne couvre pas les pièces soumises à une usure normale, lesquelles doivent donc être considérées comme des pièces d’usure (comme par ex. les piles), de même qu’elle ne couvre pas les pièces fragiles, telles que les interrupteurs, les batteries ou les pièces fabriquées en verre. Les réclamations au titre de cette garantie sont exclues si l’article a été utilisé de manière abusive ou inappropriée, hors du cadre de son usage ou du champ d’application prévu ou si les instructions de la notice d’utilisation n’ont pas été respectées, à moins que le client final ne prouve que l’article présentait un défaut de matériau ou de fabrication n’étant pas dû à l’une des conditions mentionnées ci-dessus. Les réclamations au titre de la garantie ne peuvent être adressées pendant la période de garantie qu’en présentant le ticket de caisse original. Veuillez pour cela conserver le ticket de caisse original. Ceci s’applique également aux pièces remplacées et réparées.

Si vous avez des plaintes à formuler, veuillez d’abord contacter le service d’assistance téléphonique ci-dessous ou nous contacter par courrier électronique. Si le cas est couvert par la garantie, nous nous engageons - à notre appréciation - à réparer ou à remplacer l’article gratuitement pour vous ou à vous rembourser le prix d’achat. Aucun autre droit ne découle de la garantie.

Vos droits légaux, en particulier les droits de garantie contre le vendeur concerné, ne sont pas limités par cette garantie.

Article L217-16 du Code de la consommation

Lorsque l’acheteur demande au vendeur, pendant le cours de la garantie commerciale qui lui a été consentie lors de l’acquisition ou de la réparation d’un bien meuble, une remise en état couverte par la garantie, toute période d’immobilisation d’au moins sept jours vient s’ajouter à la durée de la garantie qui restait à courir.

Cette période court à compter de la demande d’intervention de l’acheteur ou de la mise à disposition pour réparation du bien en cause, si cette mise à disposition est postérieure à la demande d’intervention.

Indépendamment de la garantie commerciale souscrite, le vendeur reste tenu des défauts de conformité du bien et des vices rédhibitoires dans les conditions prévues aux articles L217-4 à L217-13 du Code de la consommation et aux articles 1641 à 1648 et 2232 du Code Civil.

Article L217-4 du Code de la consommation

Le vendeur livre un bien conforme au contrat et répond des défauts de conformité existant lors de la délivrance. Il répond également des défauts de conformité résultant de l’emballage, des instructions de montage ou de l’installation lorsque celle-ci a été mise à sa charge par le contrat ou a été réalisée sous sa responsabilité.

Article L217-5 du Code de la consommation

Le bien est conforme au contrat :

1° S’il est propre à l’usage habituellement attendu d’un bien semblable et, le cas échéant :

- s’il correspond à la description donnée par le vendeur et posséder les qualités que celui-ci a présentées à l’acheteur sous forme d’échantillon ou de modèle ;
- s’il présente les qualités qu’un acheteur peut légitimement attendre eu égard aux déclarations publiques faites par le vendeur, par le producteur ou par son représentant, notamment dans la publicité ou l’étiquetage ;
- 2° Ou s’il présente les caractéristiques définies d’un commun accord par les parties ou être propre à tout usage spécial recherché par l’acheteur, porté à la connaissance du vendeur et que ce dernier a accepté.

Article L217-12 du Code de la consommation

L’action résultant du défaut de conformité se prescrit par deux ans à compter de la délivrance du bien.

Article 1641 du Code civil

Le vendeur est tenu de la garantie à raison des défauts cachés de la chose vendue qui la rendent impropre à l’usage auquel on la destine, ou qui diminuent tellement cet usage que l’acheteur ne l’aurait pas acquise, ou n’en aurait donné qu’un moindre prix, s’il les avait connus.

Article 1648 1er alinéa du Code civil

L’action résultant des vices rédhibitoires doit être intentée par l’acquéreur dans un délai de deux ans à compter de la découverte du vice.

Les pièces détachées indispensables à l’utilisation du produit sont disponibles pendant la durée de la garantie du produit.

IAN : 425746_2301

- Service België Tel.: 0800 12089 E-Mail : deltasport@lidl.be

Gefeliciteerd!

Met uw aankoop hebt u voor een hoogwaardig artikel gekozen. Zorg ervoor dat u voor het eerste gebruik met het artikel vertrouwd raakt.

Lees hiervoor de volgende gebruiksaanwijzing zorgvuldig door.

Gebruik het artikel alleen zoals omschreven en voor het aangegeven doel. Bewaar deze gebruiksaanwijzing goed.

Geef alle documenten mee als u het artikel aan iemand anders geeft.

In het leveringspakket inbegrepen

CL-12805

- 489 x delen
- 1 x stickervel
- 1 x montagehandleiding
- 1 x gebruiksaanwijzing

CL-12806

- 306 x delen
- 1 x stickervel
- 1 x montagehandleiding
- 1 x gebruiksaanwijzing

KB-11151

275 x delen

- 1 x stickervel
- 1 x montagehandleiding
- 1 x gebruiksaanwijzing

KB-11152

387 x delen

- 1 x stickervel
- 1 x montagehandleiding
- 1 x gebruiksaanwijzing

Technische gegevens

Productiedatum (maand/jaar): 06/2023

Hierbij verklaart Delta-Sport Handelskontor GmbH dat dit artikel voldoet aan de volgende basiseisen en de overige ter zake doende bepalingen:

2009/48/EG – Speelgoedrichtlijn

Correct gebruik

Dit artikel is speelgoed voor kinderen vanaf 5 jaar oud voor privégebruik.

⚠ Veiligheidsinstructies

- Waarschuwing. Niet geschikt voor kinderen jonger dan 36 maanden. Verstikkingsgevaar. Kleine ballen.
- Kinderen mogen alleen onder toezicht van volwassenen met het artikel spelen.
- Waarschuwing. Alle verpakings- en bevestigingsmaterialen zijn geen bestanddeel van het speelgoed en moeten omwille van de veiligheid steeds verwijderd worden voordat het product aan de kinderen overhandigd wordt om ermee te spelen.
- Controleer het artikel vóór het gebruik op beschadigingen of slijtage. Het artikel mag alleen in een perfecte staat gebruikt worden!

Opslag, reiniging

Bewaar het artikel wanneer u dit niet gebruikt altijd droog en schoon op kamertemperatuur. Veeg alleen schoon met een droge schoonmaakdoek.

BELANGRIJK! Reinig nooit met agressieve reinigingsmiddelen.

Afvalverwerking

Voer het artikel en de verpakkingsmaterialen af in overeenstemming met de actuele lokale voorschriften. Berg verpakkingsmaterialen (zoals bv. foliezakjes) op buiten het bereik van kinderen. Bijkomende informatie over de afvoer van het onbruikbaar geworden artikel krijgt u bij uw gemeente- of stadsbestuur. Voer het artikel en de verpakking milieuvriendelijk af.

De recyclingcode dient om verschillende materialen voor recyclingdoeleinden te kenmerken. De code bestaat uit een recyclingsymbool voor de recycling-cyclus en een nummer dat het materiaal kenmerkt.

Opmerkingen over garantie en serviceafhandeling

Het artikel werd met de grootste zorgvuldigheid en onder permanent toezicht geproduceerd. De firma DELTA-SPORT HANDELSKONTOR GmbH verleent particuliere eindklanten op dit artikel drie jaar garantie, te rekenen vanaf de datum van aankoop (garantietermijn) en dit op grond van de volgende bepalingen. De garantie geldt alleen voor materiaal- en verwerkingsfouten. De garantie is niet van toepassing op onderdelen die aan een normale slijtage onderhevig zijn en daarom als nietslijtvaste onderdelen te beschouwen zijn (bv. batterijen) en evenmin op breekbare onderdelen, bv. schakelaars, accu’s of onderdelen die van glas gemaakt zijn.

FR/BE	FR/BE	FR/BE	NL/BE	NL/BE

Herzlichen Glückwunsch!

Mit Ihrem Kauf haben Sie sich für einen hochwertigen Artikel entschieden. Machen Sie sich vor der ersten Verwendung mit dem Artikel vertraut.

Lesen Sie hierzu aufmerksam die nachfolgende Gebrauchsanweisung.

Benutzen Sie den Artikel nur wie beschrieben und für die angegebenen Einsatzbereiche. Bewahren Sie diese Gebrauchsanweisung gut auf. Händigen Sie alle Unterlagen bei Weitergabe des Artikels an Dritte ebenfalls mit aus.

Lieferumfang

CL-12805

- 489 x Einzelteil
- 1 x Stickerbogen
- 1 x Aufbauanleitung
- 1 x Gebrauchsanweisung

CL-12806

- 306 x Einzelteil
- 1 x Stickerbogen
- 1 x Aufbauanleitung
- 1 x Gebrauchsanweisung

KB-11151

- 275 x Einzelteil
- 1 x Stickerbogen
- 1 x Aufbauanleitung
- 1 x Gebrauchsanweisung

KB-11152

- 387 x Einzelteil
- 1 x Stickerbogen
- 1 x Aufbauanleitung
- 1 x Gebrauchsanweisung

Technische Daten

Herstellungsdatum (Monat/Jahr): 06/2023

Hiermit erklärt Delta-Sport Handelskontor GmbH, dass dieser Artikel mit den folgenden grundlegenden Anforderungen und den übrigen einschlägigen Bestimmungen übereinstimmt:

2009/48/EG – Spielzeug-Richtlinie

Bestimmungsgemäße Verwendung

Dieser Artikel ist ein Spielzeug für Kinder ab 5 Jahren für den privaten Gebrauch.

⚠ Sicherheitshinweise

- Achtung. Nicht für Kinder unter 36 Monaten geeignet. Erstickungsgefahr. Kleine Teile.
- Kinder dürfen nur unter Aufsicht von Erwachsenen mit dem Artikel spielen.
- Achtung. Alle Verpackungs- und Befestigungsmaterialien sind nicht Bestandteil des Spielzeugs und müssen aus Sicherheitsgründen stets entfernt werden, bevor der Artikel Kindern zum Spielen übergeben wird.
- Prüfen Sie den Artikel vor jedem Gebrauch auf Beschädigungen oder Abnutzungen. Der Artikel darf nur in einwandfreiem Zustand verwendet werden!

Lagerung, Reinigung

Lagern Sie den Artikel bei Nichtbenutzung immer trocken und sauber bei Raumtemperatur. Nur mit einem trockenen Reinigungstuch sauber wischen. **WICHTIG!** Nie mit scharfen Reinigungsmitteln reinigen.

Hinweise zur Entsorgung

Entsorgen Sie den Artikel und die Verpackungsmaterialien entsprechend den aktuellen örtlichen Vorschriften. Bewahren Sie Verpackungsmaterialien (wie z. B. Folienbeutel) für Kinder unerreichbar auf.

Weitere Informationen zur Entsorgung des ausgedienten Artikels erhalten Sie bei Ihrer Gemeinde- oder Stadtverwaltung. Entsorgen Sie den Artikel und die Verpackung umweltschonend.

Der Recycling-Code dient der Kennzeichnung verschiedener Materialien zur Rückführung in den Wiederverwertungskreislauf (Recycling). Der Code besteht aus einem Recyclingsymbol für den Verwertungskreislauf und einer Nummer, die das Material kennzeichnet.

Hinweise zur Garantie und Serviceabwicklung

Der Artikel wurde mit großer Sorgfalt und unter ständiger Kontrolle produziert. DELTA-SPORT HANDELSKONTOR GmbH räumt privaten Endkunden auf diesen Artikel drei Jahre Garantie ab Kaufdatum (Garantiefrist) nach Maßgabe der folgenden Bestimmungen ein. Die Garantie gilt nur für Material- und Verarbeitungsfehler. Die Garantie erstreckt sich nicht auf Teile, die der normalen Abnutzung unterliegen und deshalb als Verschleißteile anzusehen sind (z. B. Batterien) sowie nicht auf zerbrechliche Teile, z. B. Schalter, Akkus oder Teile, die aus Glas gefertigt sind.



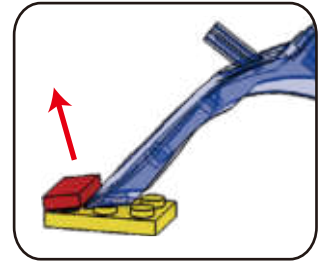
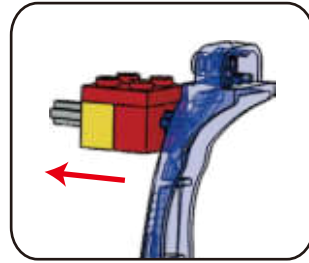
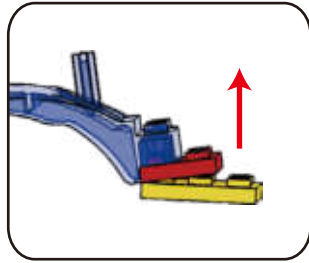
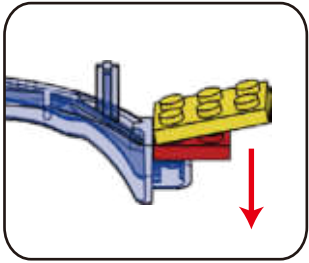

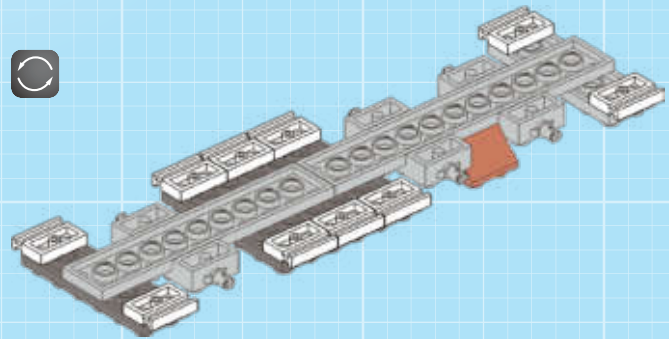
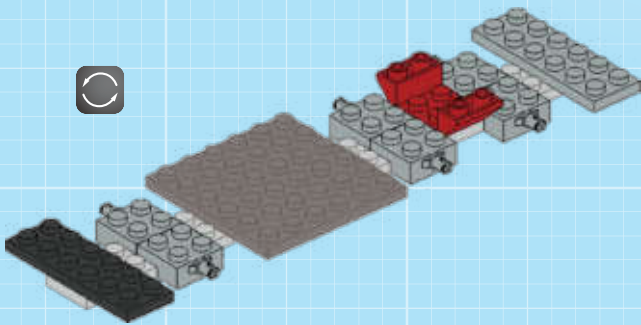
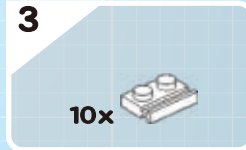
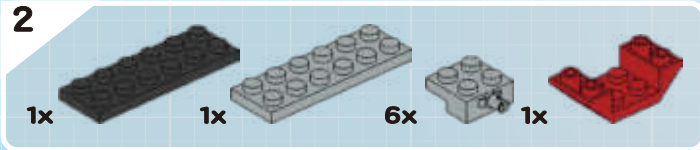
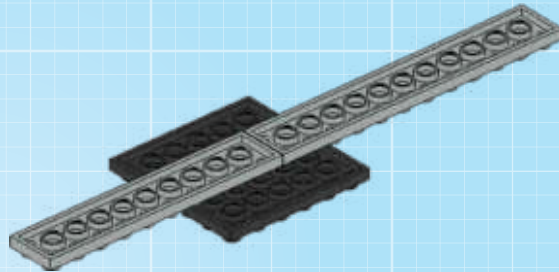
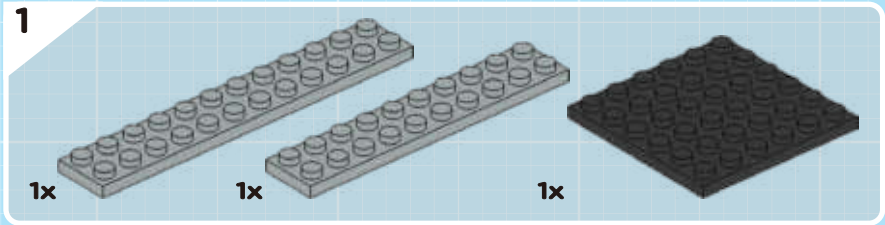
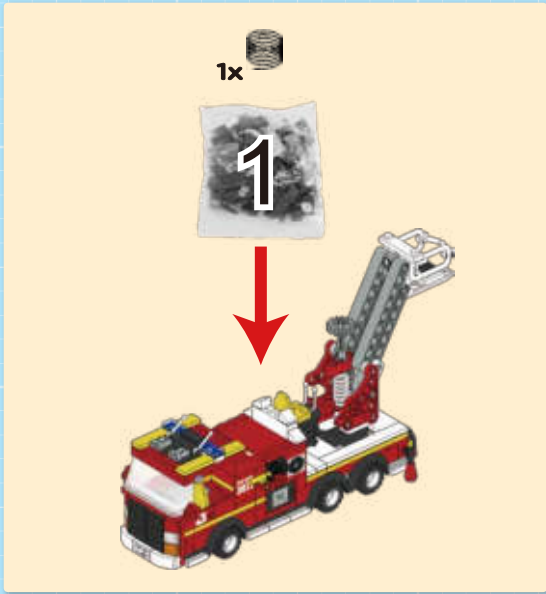

4

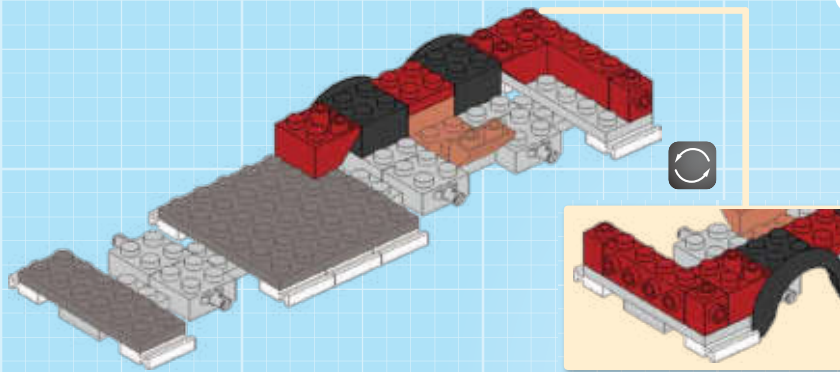
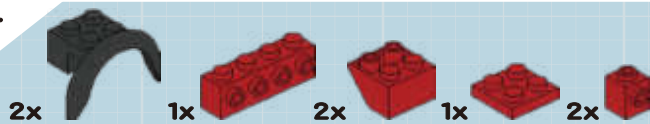

5

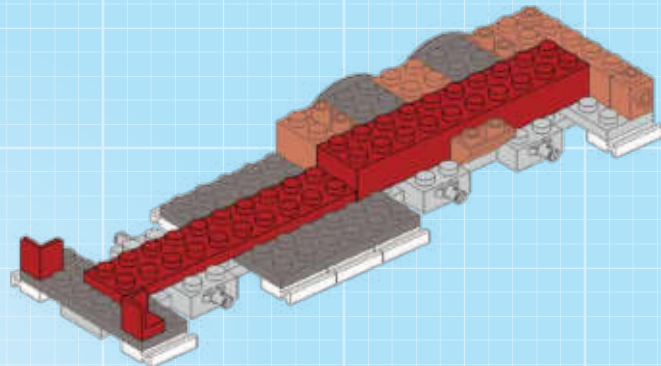
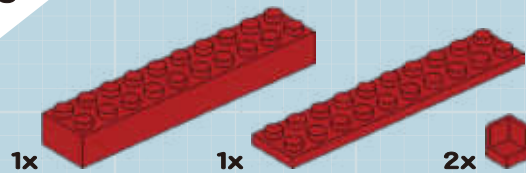

6

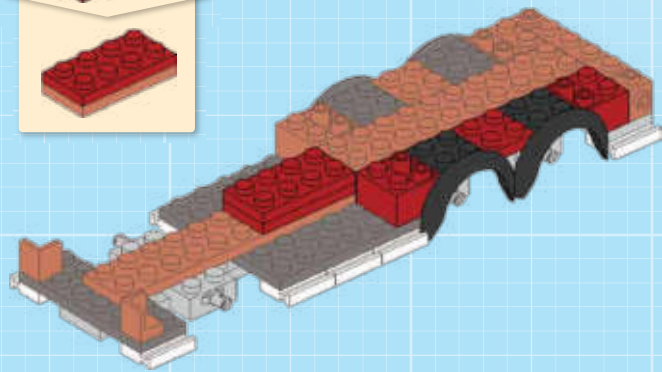
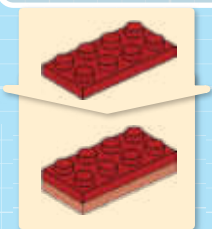
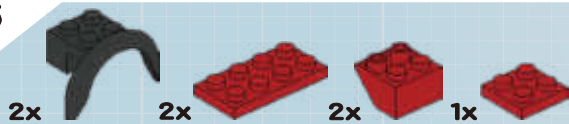

7

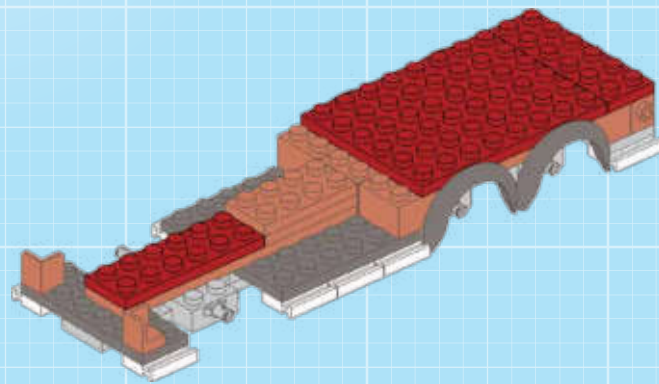
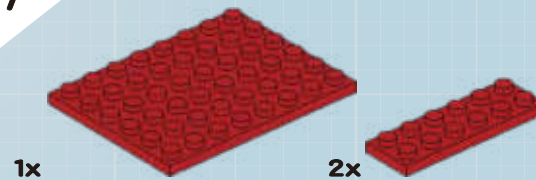

8

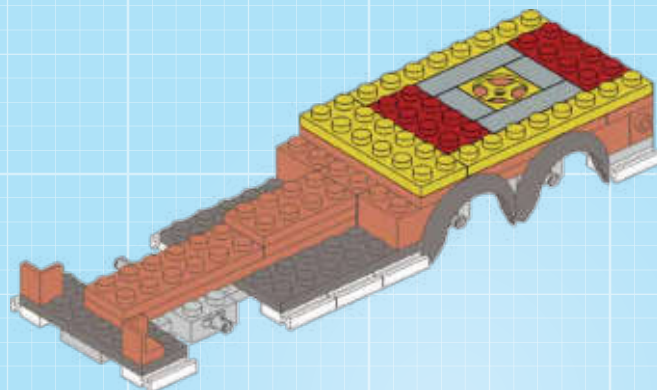

9

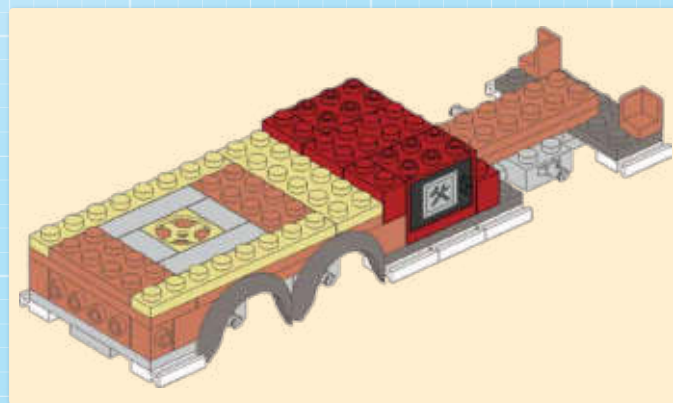
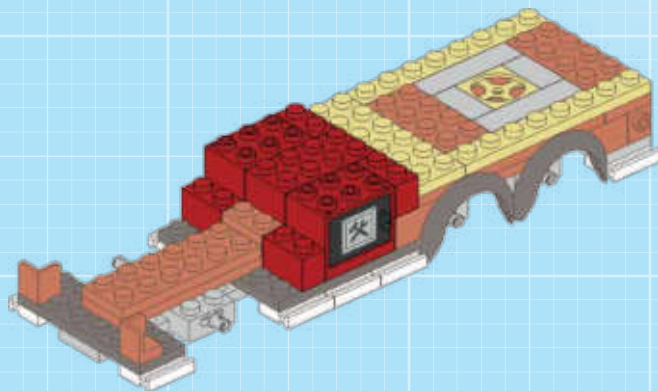
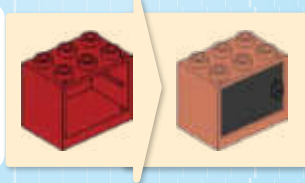
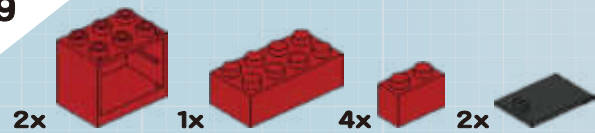

10

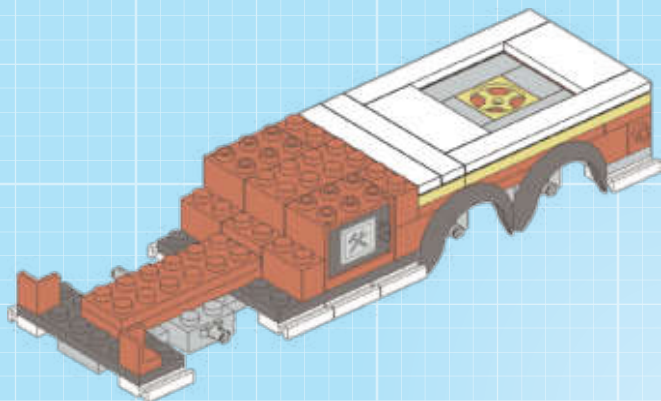
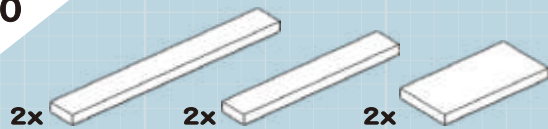



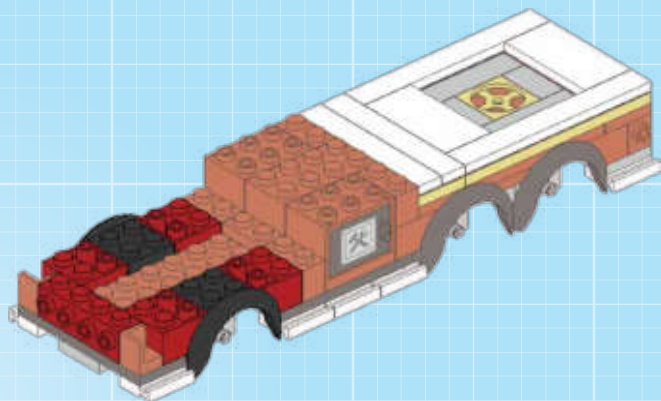
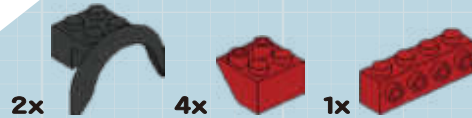

11

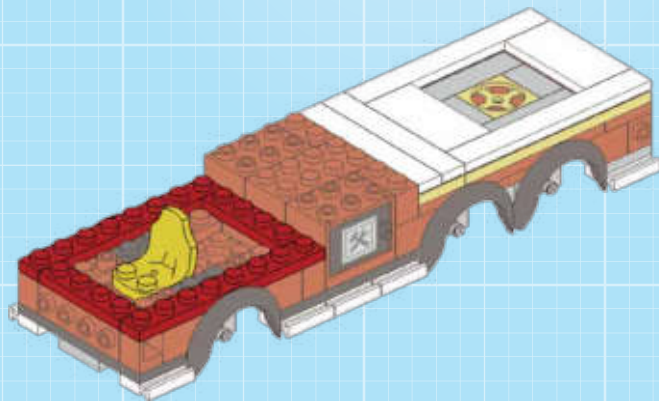

12

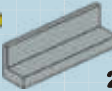

13

4x  2x  2x  1x  1x 

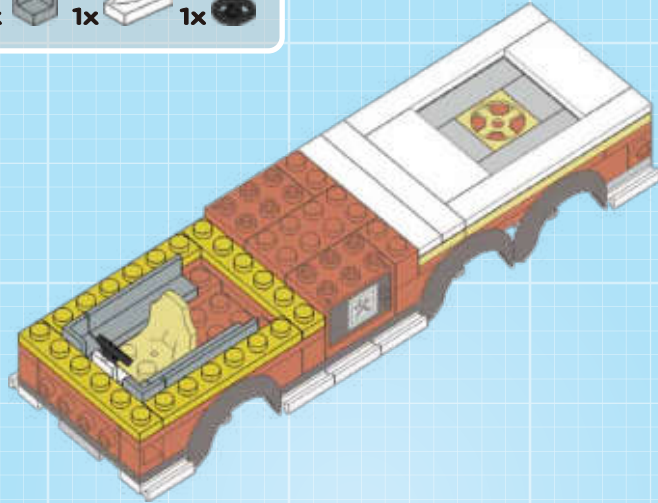

14

2x  2x  2x 

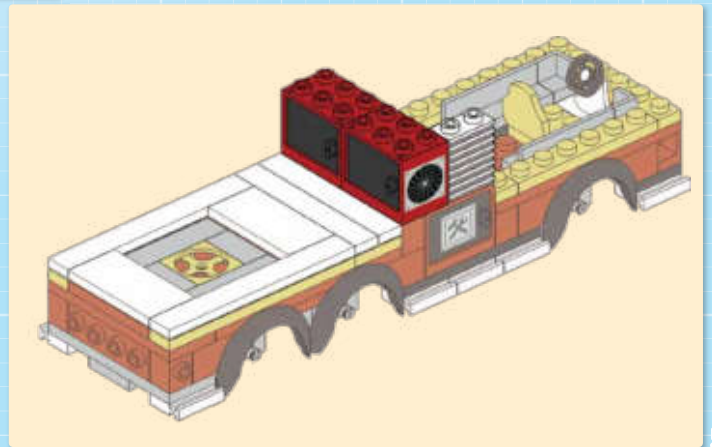
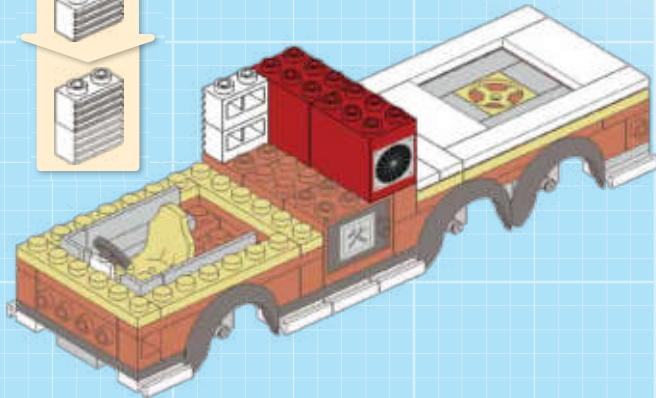
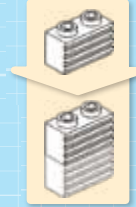

15

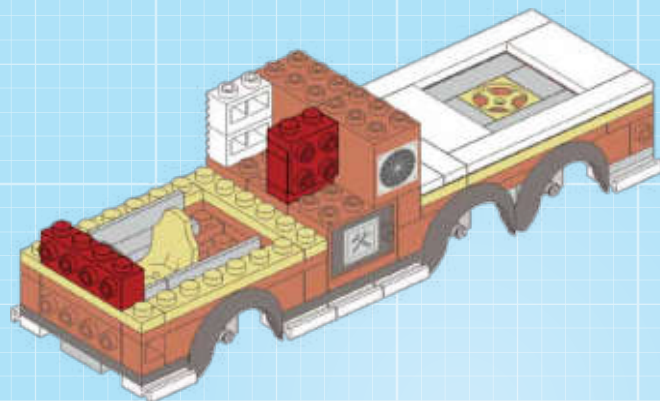

16

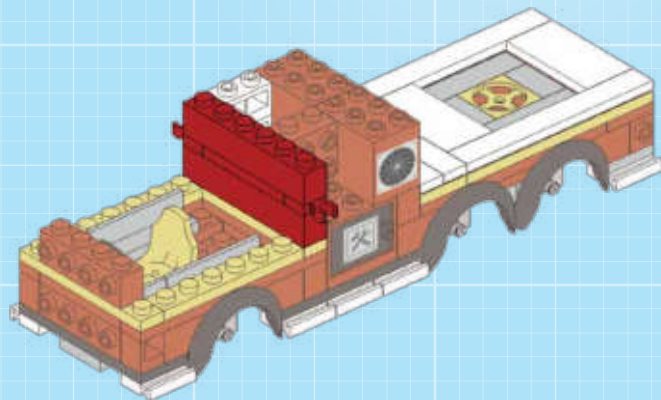
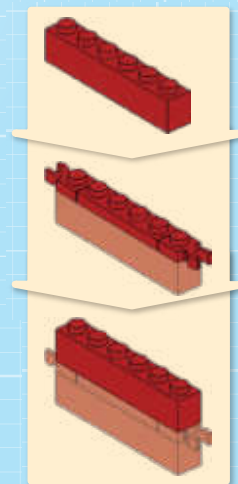
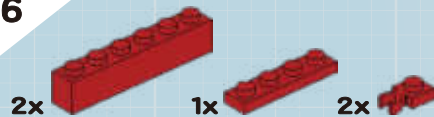

17

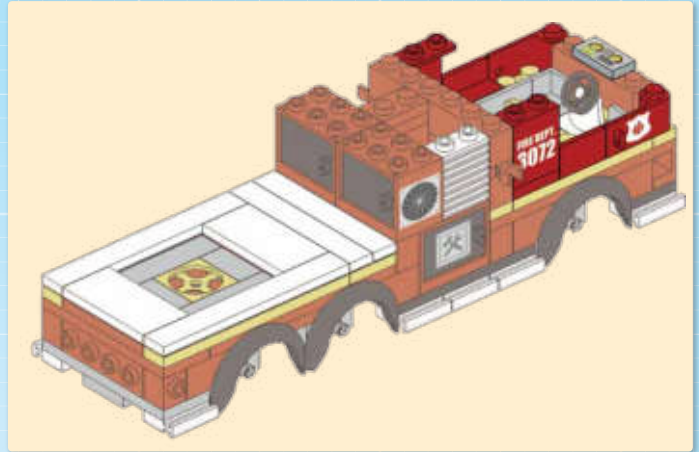
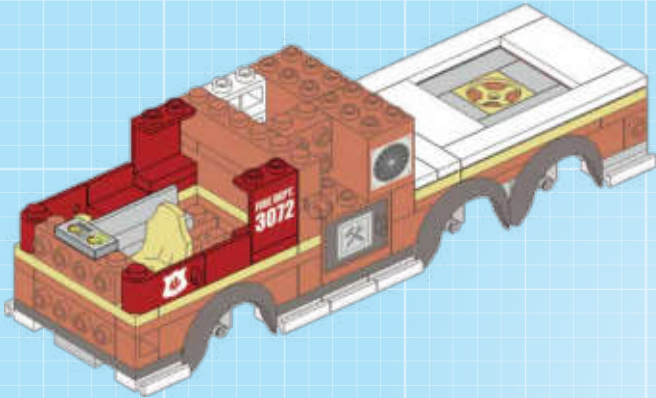
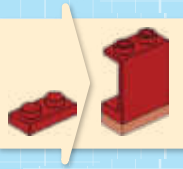
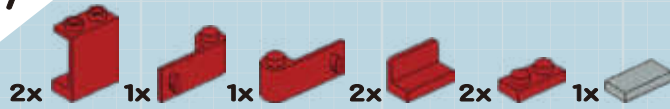

18

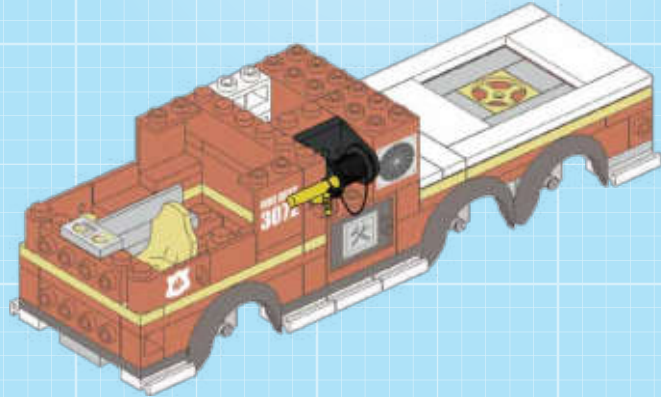

19

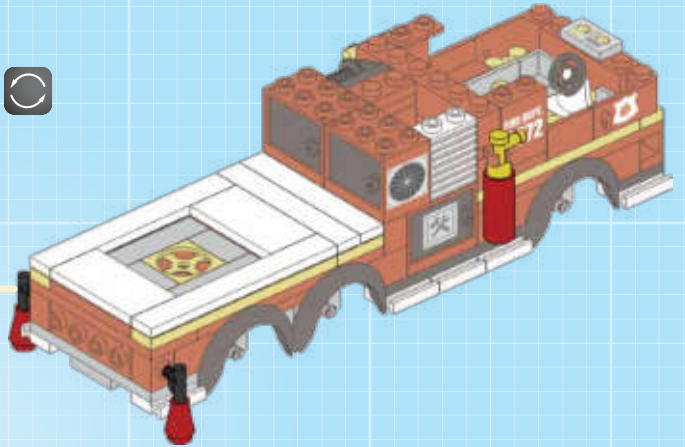
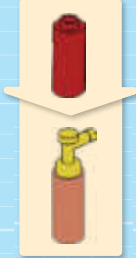
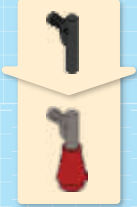

20

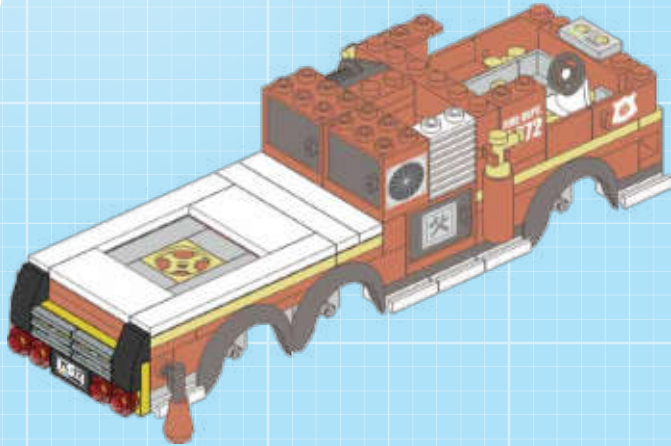
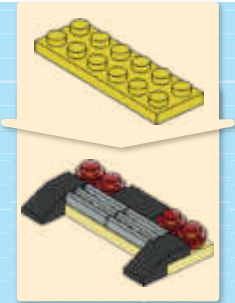

21



22

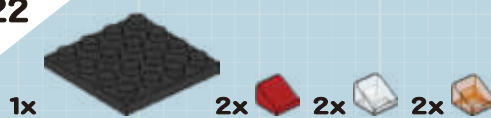

23

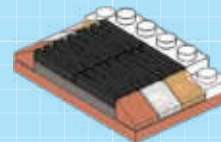

24



25

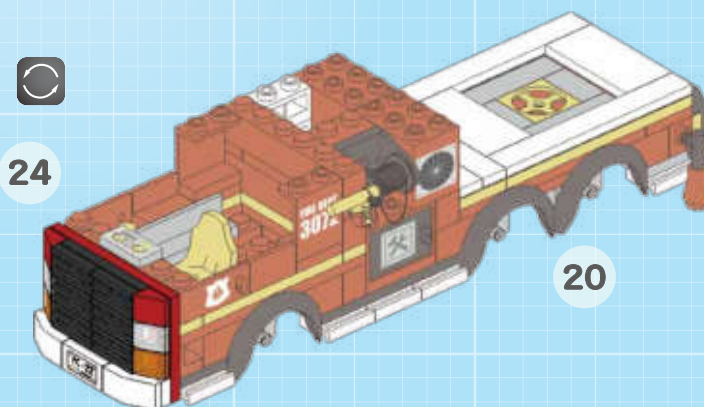

26

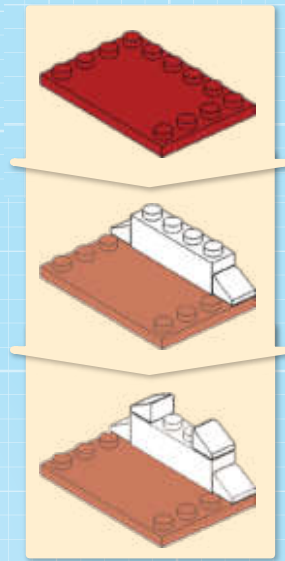
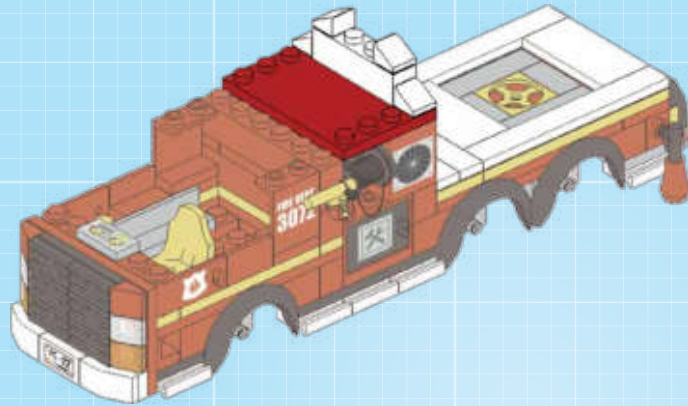
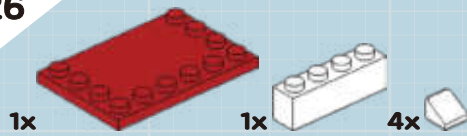

27

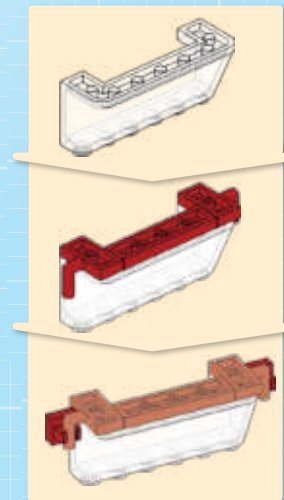
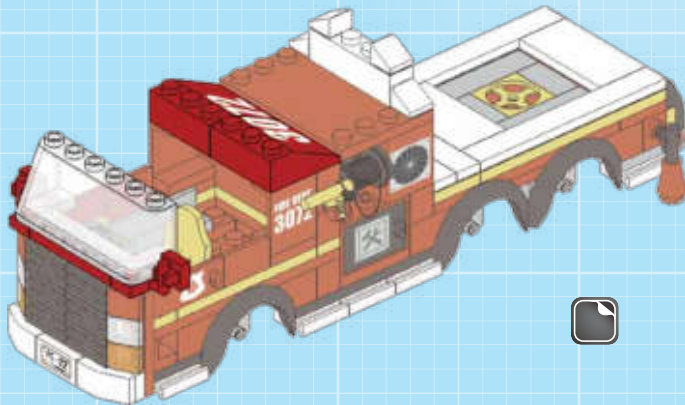

28

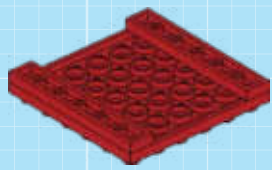
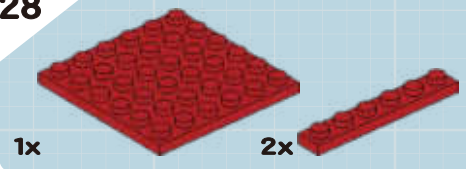

29

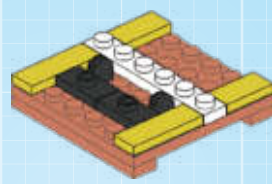
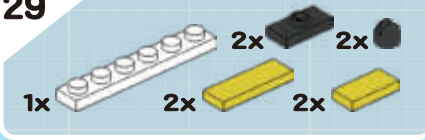

30

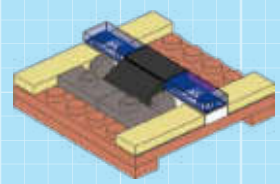
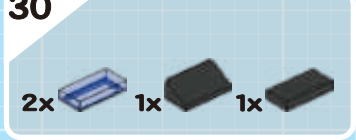

31

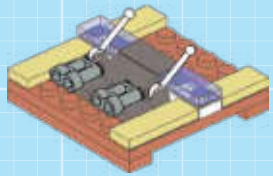
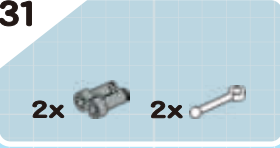

32

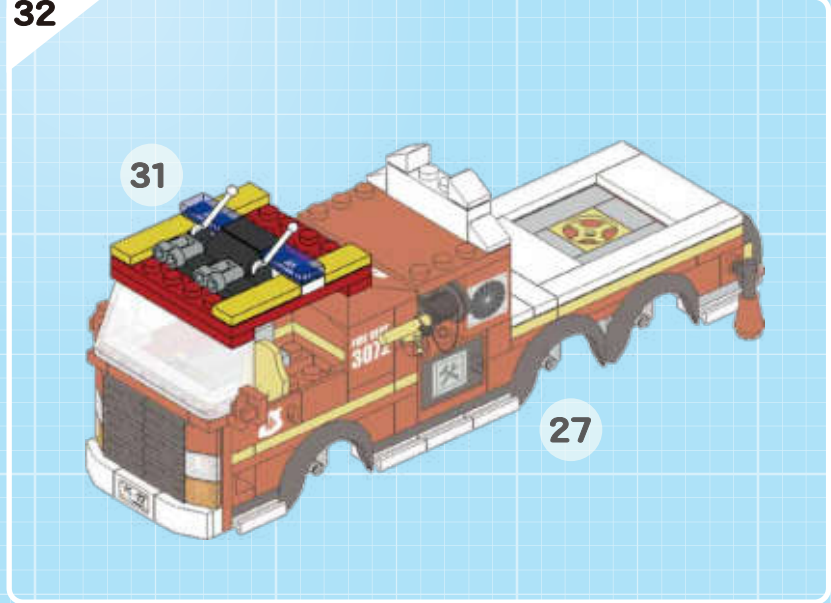

33

2x 1x



34

1x



35

1x 1x 1x

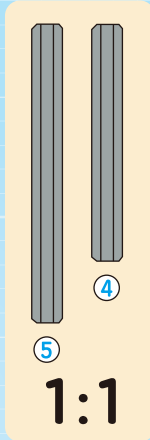
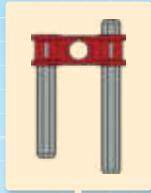

36

2x 1x 1x



37

1x 2x



38



37



34

39

1x 1x

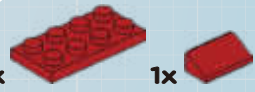

40

2x 2x



41

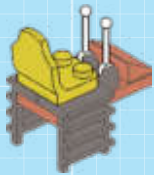

42

41

38

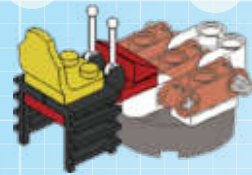

43

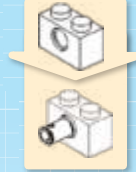

44

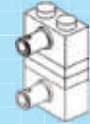

45

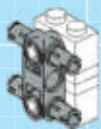

46

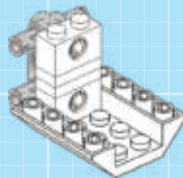
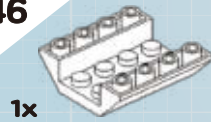

47

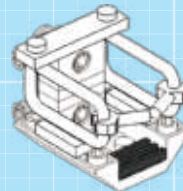
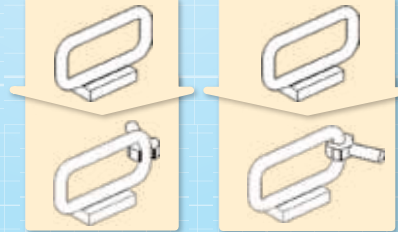
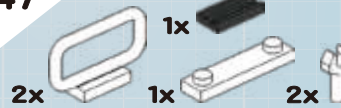

48

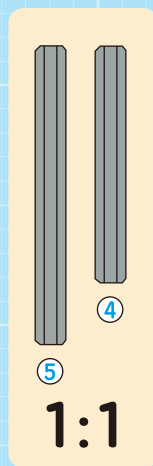
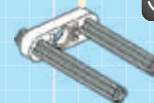
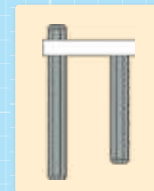
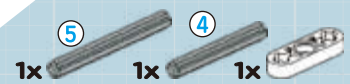

1:1

49

9

1x

1x

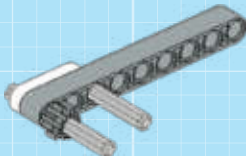
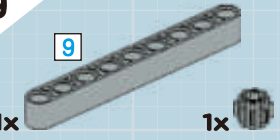

50

47

49

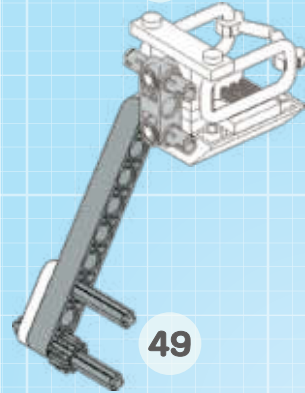

51

9

1x

1x

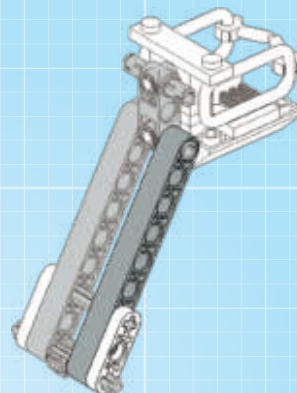
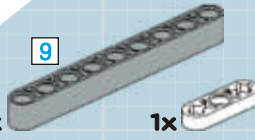

52

5

1x

1x

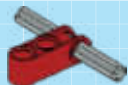

53

8

1x

1x

1x

2x

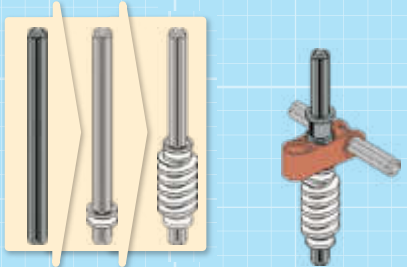

54

9

1x

1x

1x

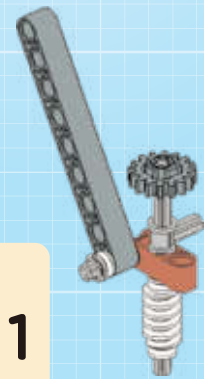
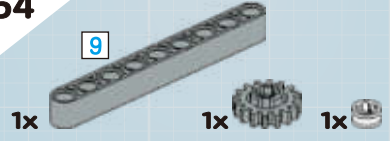

55

54

51

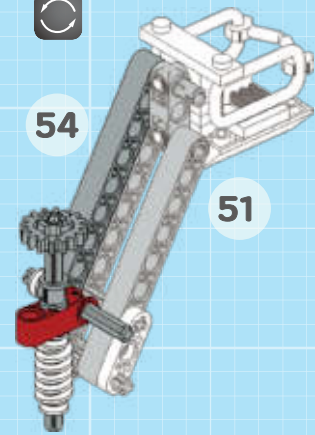

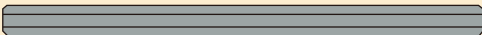
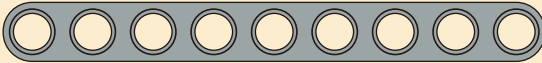
 5
 8
 9
1:1

56

9

1x

1x

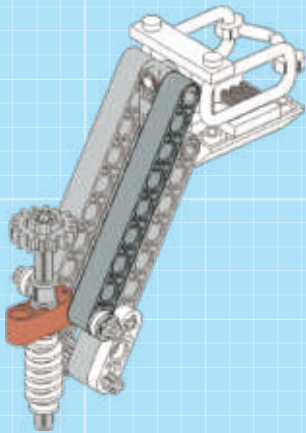
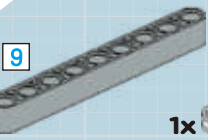

57

2x

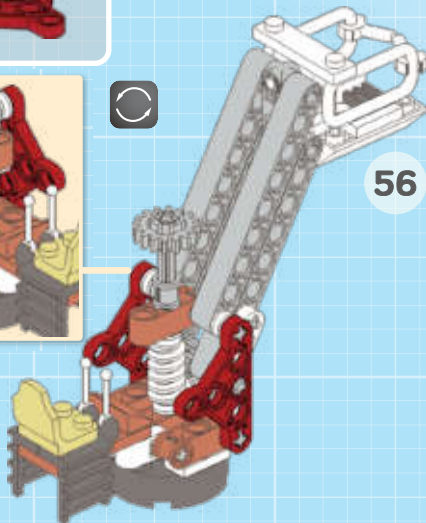
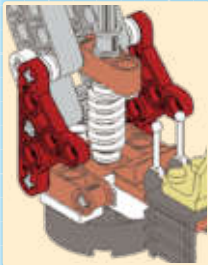

42

1:1

9

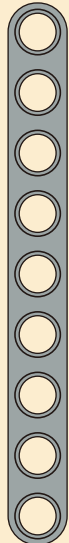

58

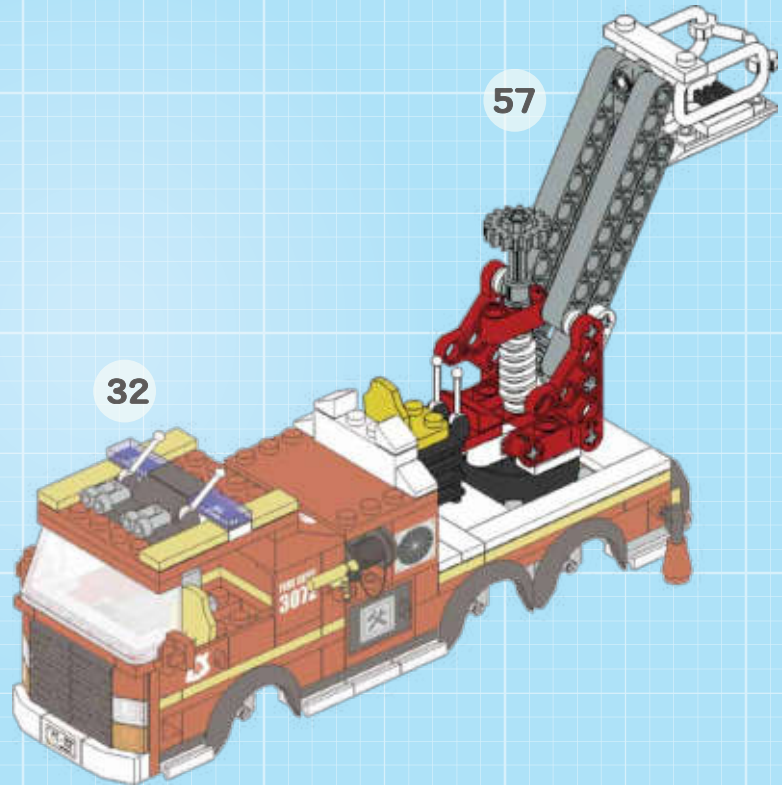

57

32

59

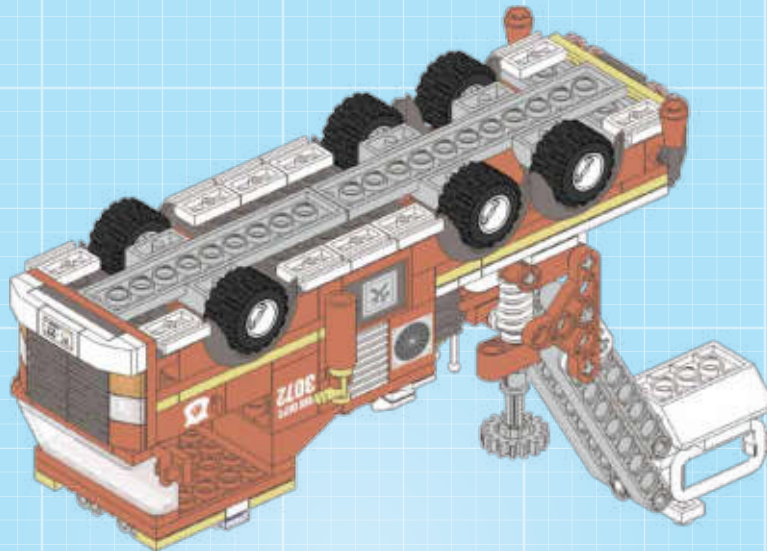
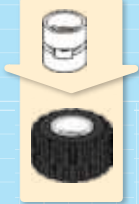

60

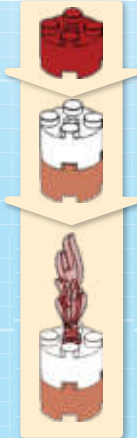

61



62

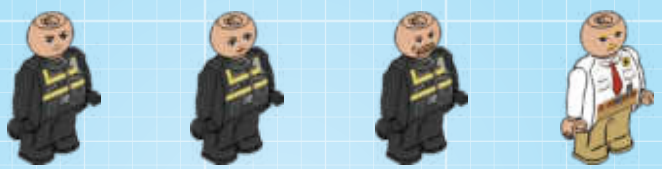
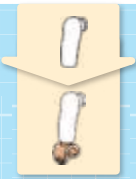
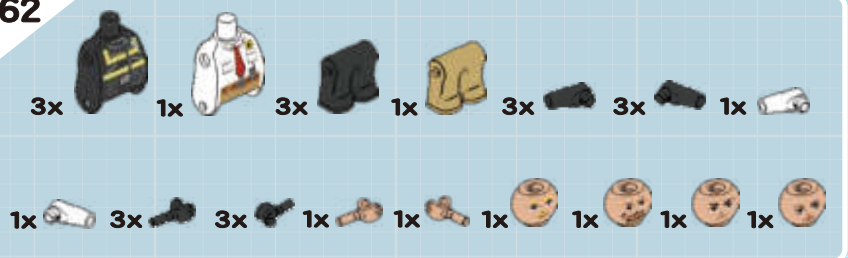

63



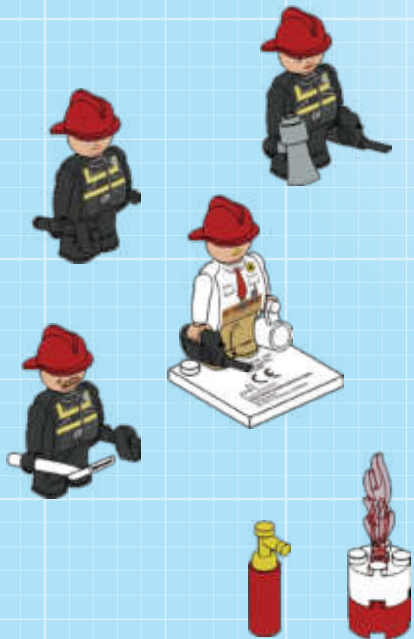
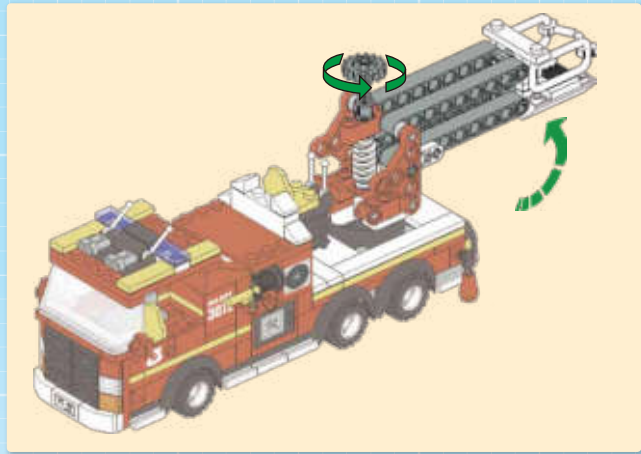

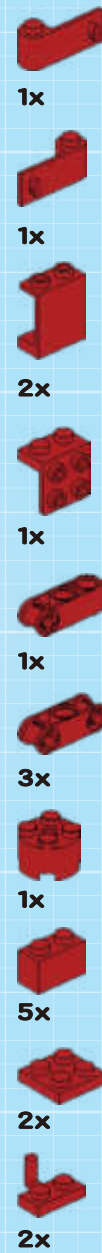
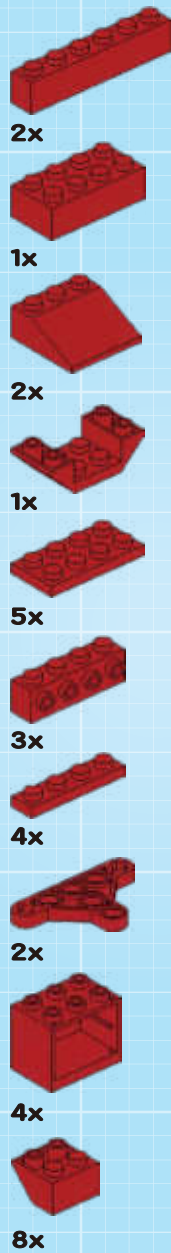
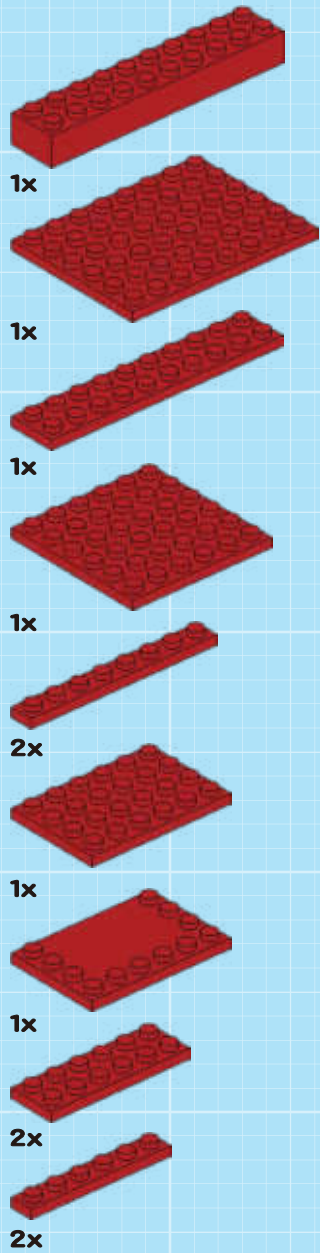

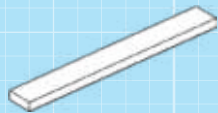

2x



1x



2x

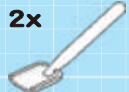

1x

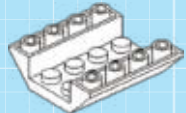

1x

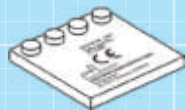

1x



2x



1x



1x



2x

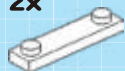

20



2x



2x



2x



2x



1x



1x



1x



2x



2x



1x



10x



2x



2x



4x



6x



1x



2x



4x



2x



4x

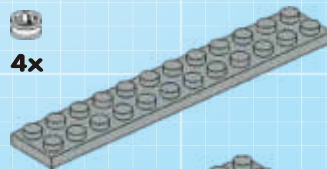

1x

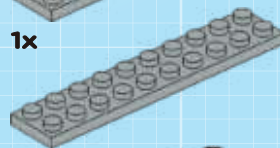

1x

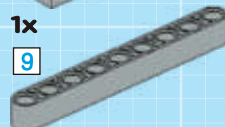

1x



4x

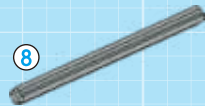

8

1x

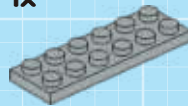

1x

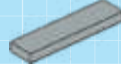

2x

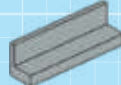

2x

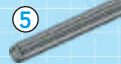

5

3x



1x



4

2x



6x



1x



1x



2x



3x



1x



2x



2x



1x



1x

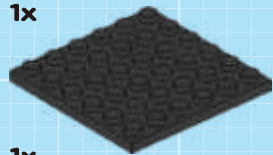

1x

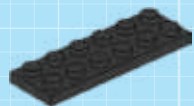

1x



1x



1x



1x



6x



2x



6x



4x



2x



2x



1x



1x



2x



2x



7x



2x



2x



1x



1x



4x



1x



2x



2x



4x



2x



2x



1x



2x



1x



2x

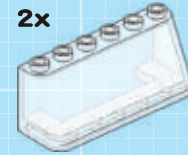

1x



2x



1x



4x



1x



2x



2x



3x



3x



1x



1x



1x



1x



1x



1x



1x



1x



1x



3x



3x



4x



1x



1x



3x



3x

