

FEUERWEHRSTATION FIRE STATION CASERNE DE POMPIERS

DE AT CH

FEUERWEHRSTATION Gebrauchsanweisung

GB IE

FIRE STATION Instructions for use

FR BE

CASERNE DE POMPIERS Notice d'utilisation

NL BE

BRANDWEERKAZERNE Gebruiksaanwijzing

PL

REMIZA STRAŻACKA Instrukcja użytkowania

CZ

POŽÁRNICKÁ STANICE Návod k použití

SK

HASIČSKÁ STANICA Navod na používanie



IAN 341722_1907



Herzlichen Glückwunsch!

Mit Ihrem Kauf haben Sie sich für einen hochwertigen Artikel entschieden. Machen Sie sich vor der ersten Verwendung mit dem Artikel vertraut.

Lesen Sie hierzu aufmerksam die nachfolgende Gebrauchsanweisung.

Benutzen Sie den Artikel nur wie beschrieben und für die angegebenen Einsatzbereiche. Bewahren Sie diese Gebrauchsanweisung gut auf. Händigen Sie alle Unterlagen bei Weitergabe des Artikels an Dritte ebenfalls mit aus.

Lieferumfang

- 840 x Einzelteil
- 1 x Aufbauanleitung
- 1 x Gebrauchsanweisung

Bestimmungsgemäße Verwendung

Dieser Artikel ist ein Spielzeug für Kinder ab 5 Jahren für den privaten Gebrauch.

Technische Daten

Herstellungsdatum (Monat/Jahr): 02/2020

Sicherheitshinweise

- Achtung. Nicht für Kinder unter 36 Monaten geeignet. Erstickengefahr. Kleine Teile.
- Achtung. Alle Verpackungs- und Befestigungsmaterialien sind nicht Bestandteil des Spielzeugs und müssen aus Sicherheitsgründen stets entfernt werden, bevor der Artikel Kindern zum Spielen übergeben wird.
- Kinder dürfen nur unter Aufsicht von Erwachsenen mit dem Artikel spielen.

Lagerung, Reinigung

Lagern Sie den Artikel bei Nichtbenutzung immer trocken und sauber bei Raumtemperatur. Nur mit einem trockenen Reinigungstuch sauber wischen. WICHTIG! Nie mit scharfen Reinigungsmitteln reinigen.

Hinweise zur Entsorgung

Entsorgen Sie den Artikel und die Verpackungsmaterialien entsprechend aktueller örtlicher Vorschriften. Verpackungsmaterialien wie z.B. Folienbeutel gehören nicht in Kinderhände. Bewahren Sie das Verpackungsmaterial für Kinder unerreichbar auf.

Entsorgen Sie den Artikel und die Verpackung umweltschonend.



Der Recycling-Code dient der Kennzeichnung verschiedener Materialien zur Rückführung in den Wiederverwertungskreislauf (Recycling).

Der Code besteht aus dem Recyclingsymbol – das den Verwertungskreislauf widerspiegeln soll – und einer Nummer, die das Material kennzeichnet.

Hinweise zur Garantie und Serviceabwicklung

Der Artikel wurde mit großer Sorgfalt und unter ständiger Kontrolle produziert. Sie erhalten auf diesen Artikel drei Jahre Garantie ab Kaufdatum. Bitte bewahren Sie den Kassenbon auf.

Die Garantie gilt nur für Material- und Fabrikationsfehler und entfällt bei missbräuchlicher oder unsachgemäßer Behandlung. Ihre gesetzlichen Rechte, insbesondere die Gewährleistungsrechte, werden durch diese Garantie nicht eingeschränkt.

Bei etwaigen Beanstandungen wenden Sie sich bitte an die unten stehende Service-Hotline oder setzen Sie sich per E-Mail mit uns in Verbindung. Unsere Servicemitarbeiter werden das weitere Vorgehen schnellstmöglich mit Ihnen abstimmen. Wir werden Sie in jedem Fall persönlich beraten.

Die Garantiezeit wird durch etwaige Reparaturen aufgrund der Garantie, gesetzlicher Gewährleistung oder Kulanz nicht verlängert. Dies gilt auch für ersetzte und reparierte Teile. Nach Ablauf der Garantie anfallende Reparaturen sind kostenpflichtig.

IAN: 341722_1907

Service Deutschland
Tel.: 0800-5435111
E-Mail: deltasport@lidl.de

Service Österreich
Tel.: 0820 201 222 (0,15 EUR/Min.)
E-Mail: deltasport@lidl.at

Service Schweiz
Tel.: 0842 665566 (0,08 CHF/Min., Mobilfunk max. 0,40 CHF/Min.)
E-Mail: deltasport@lidl.ch

Congratulations!

You have chosen to purchase a high-quality product. Familiarise yourself with the product before using it for the first time.

Read the following instructions for use carefully.

Use the product only as described and only for the given areas of application. Store these instructions for use carefully. When passing the product on to third parties, please also hand over all accompanying documents.

Contents

- 840 x parts
- 1 x assembly instructions
- 1 x instructions for use

Use according to guidelines

This product is a toy for children 5 years and up for private use.

Technical data

Date of manufacture (month/year): 02/2020

Safety Instructions

- Warning. Not suitable for children under 36 months. Choking hazard. Small balls.
- Warning. The packaging and mounting materials are not a constituent part of the toy and they must be removed in all cases for safety reasons before the product is given to children to play with.
- Children may play with this article only under adult supervision.

Storage, cleaning

When not in use, always store the product clean and dry at room temperature. Wipe clean with a dry cloth only. IMPORTANT! Never clean the product with aggressive cleaning agents.

Disposal

Dispose of the article and the packaging materials in accordance with current local regulations. Packaging materials such as foil bags are not suitable to be given to children. Keep the packaging materials out of the reach of children.

Dispose of the products and the packaging in an environmentally friendly manner.



The recycling code is used to identify various materials for recycling. The code consists of the recycling symbol – which is meant to reflect the recycling cycle – and a number which identifies the material.

Notes on the guarantee and service handling

The product was produced with great care and under constant supervision. You receive a three-year warranty for this product from the date of purchase. Please retain your receipt.

The warranty applies only to material and workmanship and does not apply to misuse or improper handling. Your statutory rights, especially the warranty rights, are not affected by this warranty.

With regard to complaints, please contact the following service hotline or contact us by e-mail. Our service employees will advise you to the subsequent procedure as quickly as possible. We will be personally available to discuss the situation with you.

Any repairs under the warranty, statutory guarantees or through goodwill do not extend the warranty period. This also applies to replaced and repaired parts. Repairs after the warranty are subject to a charge.

IAN: 341722_1907

Service Great Britain
Tel.: 0800 404 7657
E-Mail: deltasport@lidl.co.uk

Service Ireland
Tel.: 1890 930 034 (0,08 EUR/Min., (peak)) (0,06 EUR/Min., (off peak))
E-Mail: deltasport@lidl.ie

Félicitations !

Vous venez d'acquérir un article de grande qualité. Avant la première utilisation, familiarisez-vous avec l'article.

Pour cela, veuillez lire attentivement la notice d'utilisation suivante.

Utilisez l'article uniquement comme indiqué et pour les domaines d'utilisation mentionnés. Conservez bien cette notice d'utilisation. Si vous cédez l'article à un tiers, veuillez à lui remettre l'ensemble de la documentation.

Contenu de la livraison

- 840 pièces
- 1 notice de montage
- 1 notice d'utilisation

Utilisation conforme

Cet article est un jouet pour enfants à partir de 5 ans destiné à un usage privé.

Caractéristiques techniques

Date de fabrication (Mois/Année) : 02/2020

Instructions de sécurité

- Attention. Ne convient pas aux enfants de moins de 36 mois. Danger d'étouffement. Petites balles.
- Attention. Les matériaux d'emballage et de fixation ne font pas partie du jouet et doivent toujours être enlevés pour des raisons de sécurité avant que le produit ne soit remis aux enfants pour jouer.
- Les enfants ne doivent jouer avec l'article que sous la surveillance d'adultes.

Stockage, nettoyage

Lorsque vous n'utilisez pas l'article, rangez-le toujours dans un endroit sec et propre à une température ambiante. Essayez uniquement avec un chiffon de nettoyage à sec. IMPORTANT ! Ne pas nettoyer avec des nettoyeurs agressifs.

Mise au rebut

Éliminez l'article et le matériel d'emballage conformément aux directives locales en vigueur. Le matériel d'emballage tel que les sachets en plastique par exemple ne doivent pas arriver dans les mains des enfants. Conservez le matériel d'emballage hors de portée des enfants.

Ce produit est recyclable. Il est soumis à la responsabilité élargie du fabricant et est collecté séparément.



Éliminez les produits et les emballages dans le respect de l'environnement.



Le code de recyclage est utilisé pour identifier les différents matériaux pour le retour dans le circuit de recyclage. Le code se compose du symbole de recyclage, qui doit correspondre au circuit de recyclage, et d'un numéro identifiant le matériau.

Indications concernant la garantie et le service après-vente

Le produit a été fabriqué avec le plus grand soin et sous un contrôle permanent. Vous avez sur ce produit une garantie de trois ans à partir de la date d'achat. Conservez le ticket de caisse.

La garantie est uniquement valable pour les défauts de matériaux et de fabrication, elle perd sa validité en cas de maniement incorrect ou non conforme. Vos droits légaux, tout particulièrement les droits relatifs à la garantie, ne sont pas limités par cette garantie.

En cas d'éventuelles réclamations, veuillez vous adresser à la hotline de garantie indiquée ci-dessous ou nous contacter par e-mail. Nos employés du service client vous indiqueront la marche à suivre le plus rapidement possible. Nous vous renseignerons personnellement dans tous les cas.

La période de garantie n'est pas prolongée par d'éventuelles réparations sous la garantie, les garanties implicites ou le remboursement. Ceci s'applique également aux pièces remplacées et réparées. Les réparations nécessaires sont à la charge de l'acheteur à la fin de la période de garantie.

Article L217-16 du Code de la consommation

Lorsque l'acheteur demande au vendeur, pendant le cours de la garantie commerciale qui lui a été consentie lors de l'acquisition ou de la réparation d'un bien meuble, une remise en état couverte par la garantie, toute période d'immobilisation d'au moins sept jours vient s'ajouter à la durée de la garantie qui restait à courir. Cette période court à compter de la demande d'intervention de l'acheteur ou de la mise à disposition pour réparation du bien en cause, si cette mise à disposition est postérieure à la demande d'intervention. Indépendamment de la garantie commerciale souscrite, le vendeur reste tenu des défauts de conformité du bien et des vices rédhibitoires dans les conditions prévues aux articles L217-4 à L217-13 du Code de la consommation et aux articles 1641 à 1648 et 2232 du Code Civil.



Article L217-4 du Code de la consommation

Le vendeur livre un bien conforme au contrat et répond des défauts de conformité existant lors de la délivrance. Il répond également des défauts de conformité résultant de l'emballage, des instructions de montage ou de l'installation lorsque celle-ci a été mise à sa charge par le contrat ou a été réalisée sous sa responsabilité.

Article L217-5 du Code de la consommation

Le bien est conforme au contrat : 1° S'il est propre à l'usage habituellement attendu d'un bien semblable et, le cas échéant :

- s'il correspond à la description donnée par le vendeur et posséder les qualités que celui-ci a présentées à l'acheteur sous forme d'échantillon ou de modèle ;
 - s'il présente les qualités qu'un acheteur peut légitimement attendre eu égard aux déclarations publiques faites par le vendeur, par le producteur ou par son représentant, notamment dans la publicité ou l'étiquetage ;
- 2° Ou s'il présente les caractéristiques définies d'un commun accord par les parties ou être propre à tout usage spécial recherché par l'acheteur, porté à la connaissance du vendeur et que ce dernier a accepté.

Article L217-12 du Code de la consommation

L'action résultant du défaut de conformité se prescrit par deux ans à compter de la délivrance du bien.

Article 1641 du Code civil

Le vendeur est tenu de la garantie à raison des défauts cachés de la chose vendue qui la rendent impropre à l'usage auquel on la destine, ou qui diminuent tellement cet usage que l'acheteur ne l'aurait pas acquise, ou n'en aurait donné qu'un moindre prix, s'il les avait connus.

Article 1648 1er alinéa du Code civil

L'action résultant des vices rédhibitoires doit être intentée par l'acquéreur dans un délai de deux ans à compter de la découverte du vice. Les pièces détachées indispensables à l'utilisation du produit sont disponibles pendant la durée de la garantie du produit.

IAN : 341722_1907

Service France
Tel. : 0800 919270
E-Mail : deltasport@lidl.fr

Service Belgique
Tel. : 070 270 171 (0,15 EUR/Min.)
E-Mail : deltasport@lidl.be

Gefeliciteerd!

Met uw aankoop hebt u voor een hoogwaardig artikel gekozen. Zorg ervoor dat u voor het eerste gebruik met het artikel vertrouwd raakt.

Lees hiervoor de volgende gebruiksaanwijzing zorgvuldig door.

Gebruik het artikel alleen zoals omschreven en voor het aangegeven doel. Bewaar deze gebruiksaanwijzing goed. Geef alle documenten mee als u het artikel aan iemand anders geeft.

Leveringsomvang

- 840 x delen
- 1 x opbouw instructies
- 1 x gebruiksaanwijzing

Correct gebruik

Dit artikel is speelgoed voor kinderen vanaf 5 jaar oud voor privégebruik.

Technische gegevens

Productiedatum (maand/jaar): 02/2020

Veiligheidsinstructies

- Waarschuwing. Niet geschikt voor kinderen jonger dan 36 maanden. Verstikkingsgevaar. Kleine ballen.
- Waarschuwing. Alle verpakings- en bevestigingsmaterialen zijn geen onderdeel van het speelgoed en moeten omwille van de veiligheid steeds verwijderd worden voordat het product aan de kinderen overhandigd wordt om ermee te spelen.
- Kinderen mogen alleen onder toezicht van volwassenen met het artikel spelen.

Opslag, reiniging

Bewaar het artikel wanneer u dit niet gebruikt altijd droog en schoon op kamertemperatuur. Veeg alleen schoon met een droge schoonmaakdoek. BELANGRIJK! Reinig nooit met agressieve reinigingsmiddelen.

Afvalverwerking

Voer het artikel en verpakkingsmaterialen in overeenstemming met actuele lokale voorschriften af. Verpakkingsmaterialen, zoals bv. foliezakjes, horen niet thuis in kinderhanden. Berg het verpakkingsmateriaal buiten het bereik van kinderen op.

Voer de producten en verpakkingen op milieuvriendelijke wijze af.

 De recyclingcode dient om verschillende materialen te kenmerken ten behoeve van hergebruik via het recyclingproces. De code bestaat uit het recyclingsymbool, dat het recyclingproces weerspiegelt, en een getal dat het materiaal identificeert.

Opmerkingen over garantie en serviceafhandeling

Het product is geproduceerd met grote zorg en onder voortdurende controle. U ontvangt een garantie van drie jaar op dit product, vanaf de datum van aankoop. Bewaar alstublieft uw aankoopbewijs.

De garantie geldt alleen voor materiaal- en fabricagefouten en vervalt bij foutief of oneigenlijk gebruik. Uw wettelijke rechten, met name het garantierecht, worden niet beïnvloed door deze garantie.

In geval van reclamaties dient u zich aan de beneden genoemde service-hotline te wenden of zich per e-mail met ons in verbinding te zetten. Onze servicemedewerkers zullen de verdere handelswijze zo snel mogelijk met u afspreken. Wij zullen u in ieder geval persoonlijk te woord staan.

De garantieperiode wordt na eventuele reparaties en op basis van de garantie, wettelijke garantie of coulance niet verlengd. Dit geldt ook voor vervangen en gerepareerde delen. Na afloop van de garantieperiode dienen eventuele reparaties te worden betaald.

IAN: 341722_1907

 Service België
Tel.: 070 270 171 (0,15 EUR/Min.)
E-Mail: deltasport@lidl.be

 Service Nederland
Tel.: 0900 0400223
(0,10 EUR/Min.)
E-Mail: deltasport@lidl.nl

Gratulujemy!
Decydując się na ten produkt, otrzymują Państwo towar wysokiej jakości. Należy zapoznać się z produktem przed jego pierwszym użyciem.

Należy uważnie przeczytać następującą instrukcję użytkownika.

Produkt ten należy użytkować wyłącznie w opisany sposób oraz zgodnie ze wskazanym przeznaczeniem. Niniejszą instrukcję użytkownika należy przechowywać w bezpiecznym miejscu. Przekazując produkt innej osobie, należy upewnić się, że otrzyma ona także całą dokumentację dotyczącą produktu.

Zakres dostawy

840 x elementów
1 x instrukcja montażu
1 x instrukcja użytkownika

Zastosowanie zgodne z przeznaczeniem

Ten produkt jest zabawką dla dzieci od 5. roku życia i jest przeznaczony do użytku prywatnego.

Dane techniczne

 Data produkcji (miesiąc/rok): 02/2020

Wskazówki bezpieczeństwa

- Ostrzeżenie. Nie nadaje się dla dzieci w wieku poniżej 36 miesięcy. Niebezpieczeństwo udławienia się. Małe kulki.
- Ostrzeżenie. Opakowanie oraz materiały mocujące nie są częścią zabawki i ze względów bezpieczeństwa muszą być zawsze usunięte, zanim artykuł będzie przekazany dzieciom do zabawy.
- Dzieci mogą bawić się artykułem tylko pod nadzorem osób dorosłych.

Przechowywanie, czyszczenie

Podczas nieużywania należy zawsze przechowywać produkt w suchym i czystym miejscu, w temperaturze pokojowej. Wycierać do czysta jedynie suchą ściereczką. WAŻNE! Nie czyszczyć przy użyciu ostrych środków czyszczących.

Uwagi odnośnie recyklingu

Artykuł oraz materiały opakowaniowe należy usunąć zgodnie z aktualnymi przepisami obowiązującymi w danym miejscu. Materiały opakowaniowe, jak np. worki foliowe nie powinny znaleźć się w rękach dzieci. Materiał opakowaniowy należy przechowywać w miejscu niedostępnym dla dzieci.

 Zutilizować produkt i opakowanie w sposób przyjazny dla środowiska.

 Kod materiału do recyklingu służy do oznaczenia różnych materiałów przeznaczonych do zwrotu do przetwórstwa wtórnego (recyklingu). Kod składa się z symbolu, który powinien odzwierciedlać cykl odzysku, oraz numeru oznaczającego materiał.

Wskazówki dotyczące gwarancji i obsługi serwisowej

Produkt został wyprodukowany bardzo starannie i podczas stałej kontroli. Państwo otrzymują na ten produkt trzy lata gwarancji od daty zakupu. Prosimy o zachowanie paragonu.

Gwarancja obejmuje tylko błędy materiałowe lub fabryczne i traci ważność podczas używania produktu nie właściwie i nie zgodnie z jego przeznaczeniem. Państwa prawa, w szczególności zasady odpowiedzialności z tytułu rękojmi, nie zostaną ograniczone tą gwarancją. W razie ewentualnych reklamacji należy skontaktować się pod niżej podanym numerem infolinii lub poprzez pocztę elektroniczną. Nasi współpracownicy omówią z Państwem jak najszybciej dalszy przebieg sprawy. Z naszej strony gwarantujemy doradztwo.

W przypadku wymiany części lub całego artykułu okres gwarancji przedłuża się o trzy lata zgodnie z art. 581 § 1 kodeksu cywilnego. Po upływie czasu gwarancji powstałe naprawy są płatne.

IAN: 341722_1907

 Serwis Polska
Tel.: 22 397 4996
E-Mail: deltasport@lidl.pl

Srdečně blahopřejeme!
Svým nákupem jste se rozhodli pro kvalitní výrobek. Před prvním použitím se prosím seznamte s tímto výrobkem.

Pozorně si přečtete následující návod k použití.

Používejte tento výrobek pouze tak, jak je popsáno, a pro uvedené účely. Uschovejte si tento návod k použití pro budoucí použití. Pokud výrobek předáte třetí osobě, předejte jí i veškerou dokumentaci.

Obsah balení

840 x dílů
1 x montážní návod
1 x návod k použití

Použití k určitému účelu

Tento výrobek je hračka pro děti od 5 let, je určen jen pro soukromé použití.

Technické údaje

 Datum výroby (měsíc/rok): 02/2020

Poznámky k bezpečnosti

- Upozornění. Nevhodné pro děti mladší 36 měsíců. Nebezpečí zalknutí. Malé koule.
- Upozornění. Veškeré obalové a upevňovací materiály nejsou součástí hračky a z bezpečnostních důvodů musí být vždy odstraněny před tím, než je výrobek předán dětem na hraní.
- Děti si smějí s výrobkem hrát jen pod dohledem dospělých.

Uskladnění, čištění

Pokud výrobek nepoužíváte, skladujte jej vždy suchý a čistý při pokojové teplotě. Utírejte pouze suchým hadříkem. DŮLEŽITÉ! K čištění nikdy nepoužívejte agresivní čisticí prostředky.

Pokyny k likvidaci

Výrobek a obalový materiál likvidujte do odpadu podle aktuálních místních předpisů. Obalový materiál, jako např. fóliové sáčky, nepatří do dětských rukou. Obalový materiál uchovávejte z dosahu dětí.

 Zlikvidujte produkty a balení ekologicky.

 Recyklační kód identifikuje různé materiály pro recyklaci. Kód se skládá z recyklačního symbolu - který indikuje recyklační cyklus - a čísla identifikujícího materiál.

Pokyny k záruce a průběhu služby

Produkt byl vyrobený s velkou pečlivostí a byl průběžně kontrolován ve výrobní procesu. Na tento produkt obdržíte tříroční záruku ode dne zakoupení. Uschovejte si pokladní stvrzenku. Záruka se vztahuje jen na vady materiálu a chyby z výroby, nevztahuje se na závady způsobené neodborným zacházením nebo použitím k jinému účelu. Tato záruka neomezuje Vaše zákonná ani záruční práva.

Při případných reklamacích se obraťte na dole uvedenou servisní linku nebo nám zašlete email. Náš servisní pracovník s Vámi co nejdříve upřesní další postup. V každém případě Vám osobně poradíme.

Záruční doba se neprodlužuje po případných opravách v době záruky ani v případě zákonného ručení nebo kulance. Toto platí také pro náhradní a opravené díly. Opravy prováděné po vypršení záruční lhůty se platí.

IAN: 341722_1907

 Servis Česko
Tel.: 800143873
E-Mail: deltasport@lidl.cz

Blahoželáme!
Svojím nákupom ste sa rozhodli pre kvalitný výrobok. Pred prvým použitím sa s výrobkom dôkladne oboznámte.

Pozorne si prečítajte tento návod na používanie.

Výrobok používajte len uvedeným spôsobom a na uvedený účel. Tento návod na používanie si dobre uschovajte. Pri odovzdávaní výrobku tretej osobe odovzdajte s výrobkom aj všetky podklady.

Obsah balení

840 x diel
1 x návod k montáži
1 x návod na používanie

Použitie podľa predpisov

Tento výrobok je hračka pre deti od 5 rokov, určená na súkromné použitie.

Technické údaje

 Dátum výroby (mesiac/rok): 02/2020

Bezpečnostné pokyny

- Upozornenie. Nevhodné pre deti vo veku do 36 mesiacov. Nebezpečenstvo dusenia. Malé guľky.
- Upozornenie. Všetok obalový a upevňovací materiál nie je súčasťou hračky a musíte ho z bezpečnostných dôvodov odstrániť predtým, než výrobok odovzdáte deťom na hranie.
- Deti sa smú hrať s výrobkom len pod dohľadom dospelých.

Skladovanie, čistenie

Pri nepoužívaní skladujte výrobok vždy suchý a čistý pri izbovej teplote. Čistite iba suchou handričkou. DŮLEŽITÉ! Výrobok nikdy nečistite ostrými čisticími prostriedkami.

Pokyny k likvidácii

Výrobok a obalový materiál zlikvidujte v súlade s aktuálnymi miestnymi predpismi. Obalový materiál, ako napr. fóliové vrecúško nepatří do rúk detí. Obalový materiál uschovajte mimo dosahu detí.

 Výrobky a obaly likvidujte ekologickým spôsobom.

 Recyklačný kód slúži na označenia rôznych materiálov na navrátenie do obehu opätovného využitia. Kód sa skladá z recyklačného symbolu - ktorý má odzrkadľovať zhodnotenie recyklačného obehu - a číslo označujúce materiál.

Pokyny k záruke a priebehu servisu

Produkt bol vyrobený s maximálnou zodpovednosťou a v priebehu výroby bol neustále kontrolovaný. Na tento produkt máte tri roky záruku od dátumu kúpy produktu. Pokladničný lístok si odložte.

Záruka sa vzťahuje len na chyby materiálu a výrobné chyby a zaniká pri neodbornej manipulácii s produktom. Záruka nemá vplyv na Vaše zákonné práva, predovšetkým na práva vyplývajúce zo záruky.

V prípade reklamácie sa obráťte na nižšie uvedenú servisnú linku, alebo nám napíšte e-mail. Naši servisní zamestnanci sa s Vami dohodnú na ďalšom postupe a urýchlene vykonajú všetky potrebné kroky. V každom prípade Vám poradíme osobne.

Záručná lehota sa nepredlžuje v dôsledku eventuality opráv na základe záruky, zákonného plnenia záruky alebo v dôsledku prejavu ochoty. To platí tiež pre vymenené alebo opravené diely. Opravy vykonané po uplynutí záručnej lehoty sú spoplatnené.

IAN: 341722_1907

 Servis Slovensko
Tel.: 0850 232001
E-Mail: deltasport@lidl.sk



DELTA-SPORT HANDELSKONTOR GMBH
Wagekamp 6 • DE:22397 Hamburg
GERMANY

 02/2020

Delta-Sport-Nr.: KB-6749

12.03.2019 / PM 2.98

IAN 341722_1907

8

NL/BE

PL

PL

CZ

CZ

SK

SK



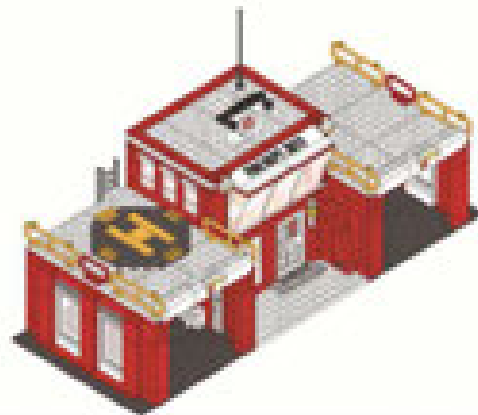
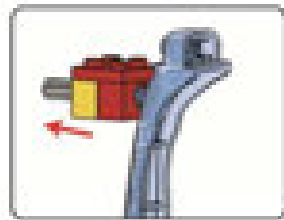
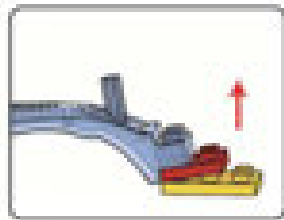
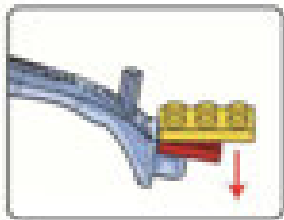

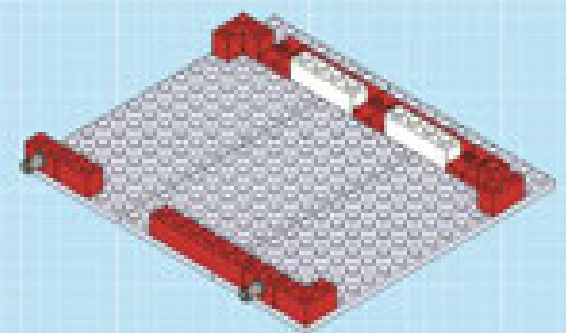
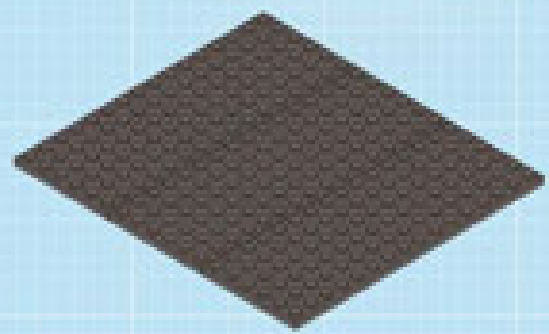
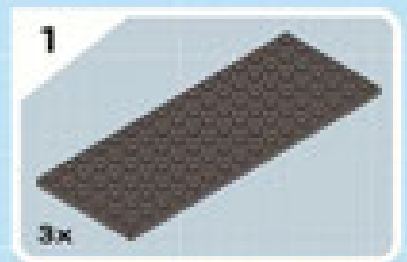
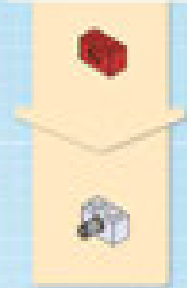
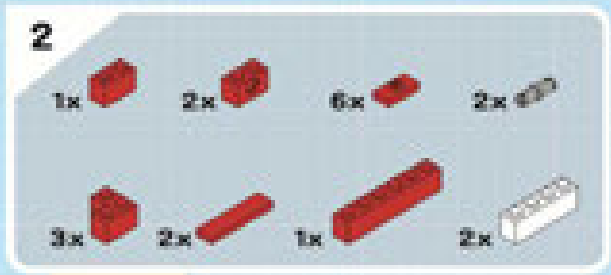
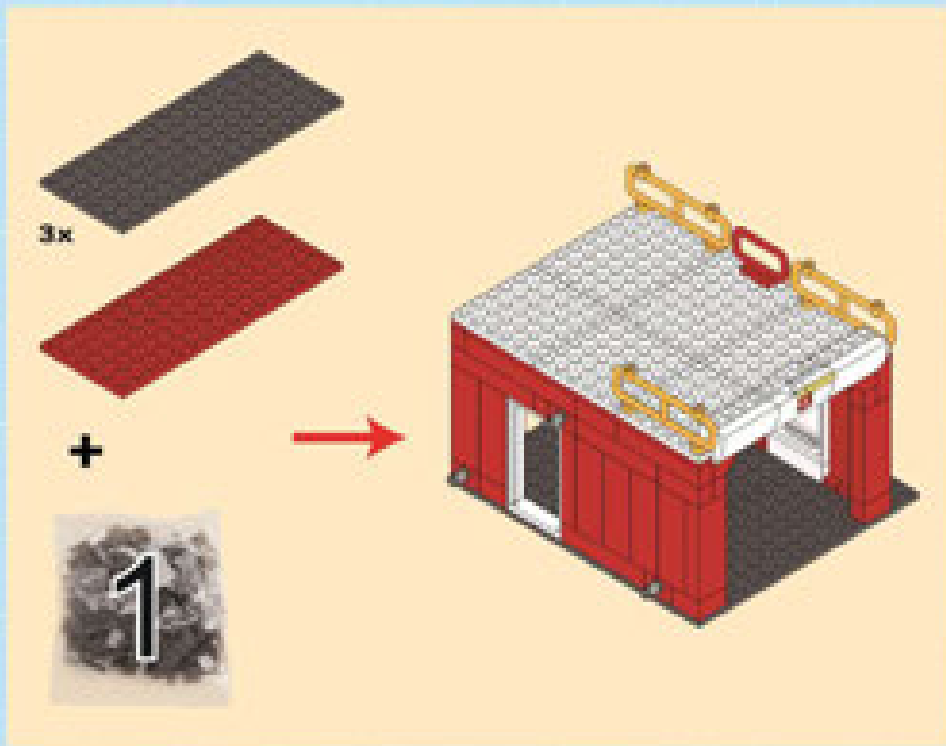

3

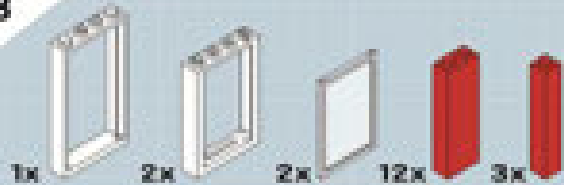

4

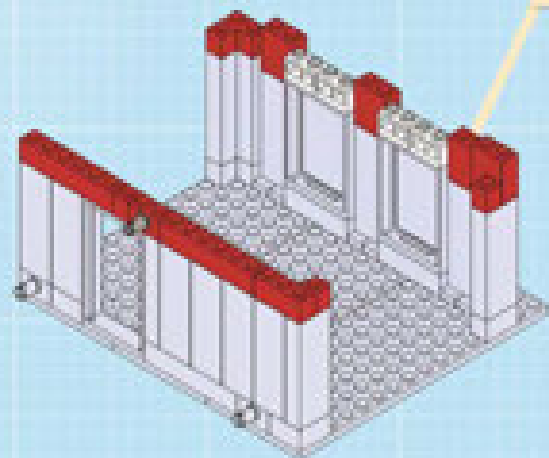
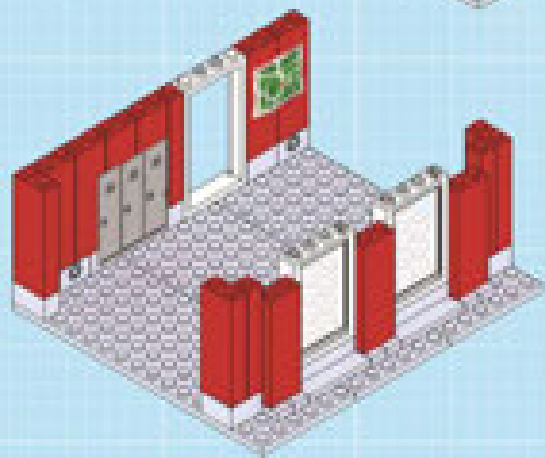
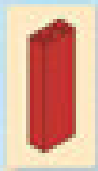
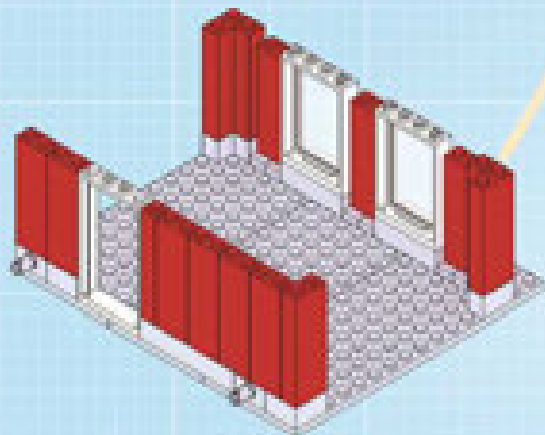
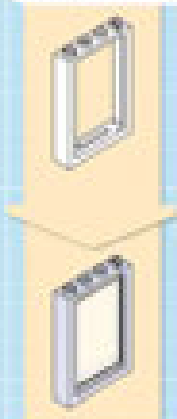

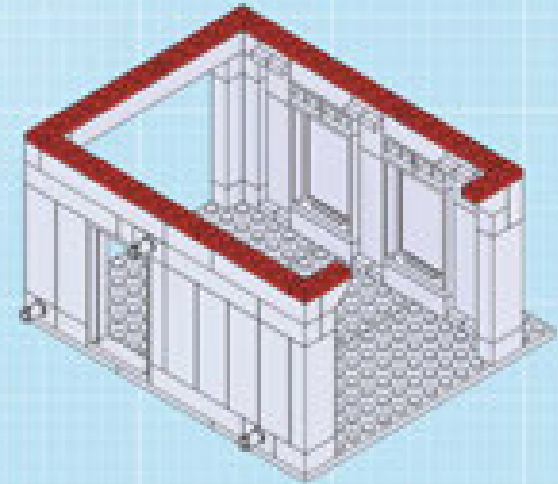
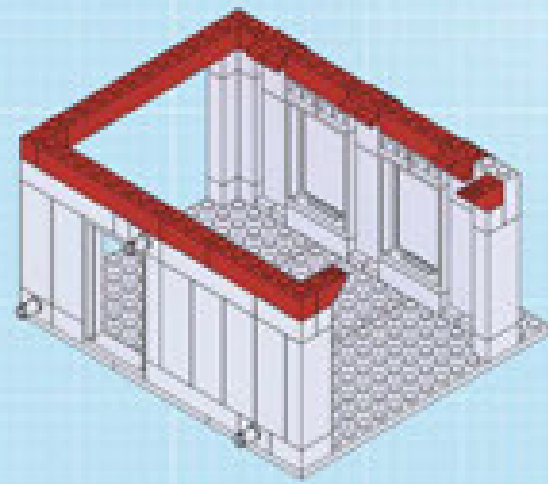
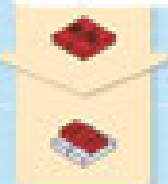
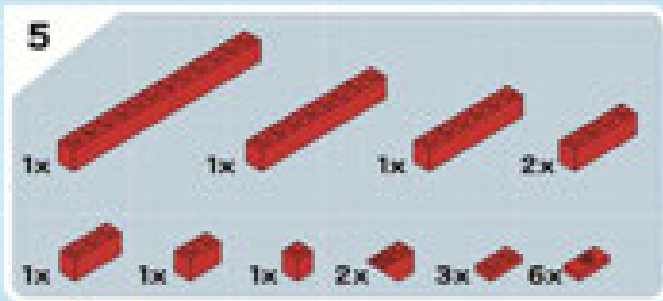

7

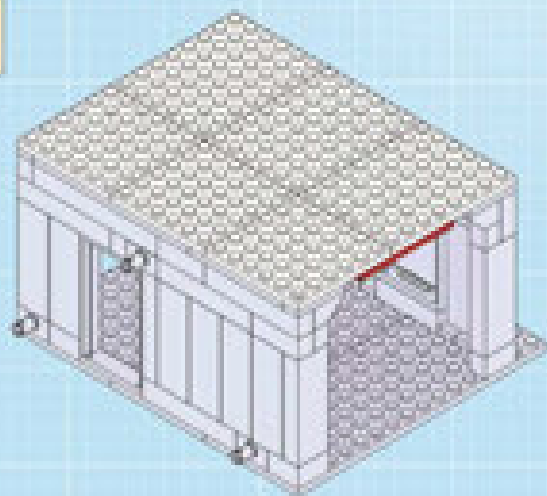
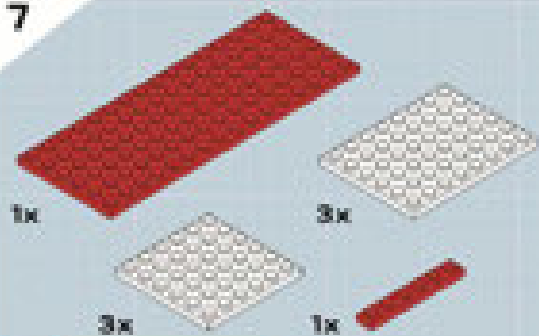

8

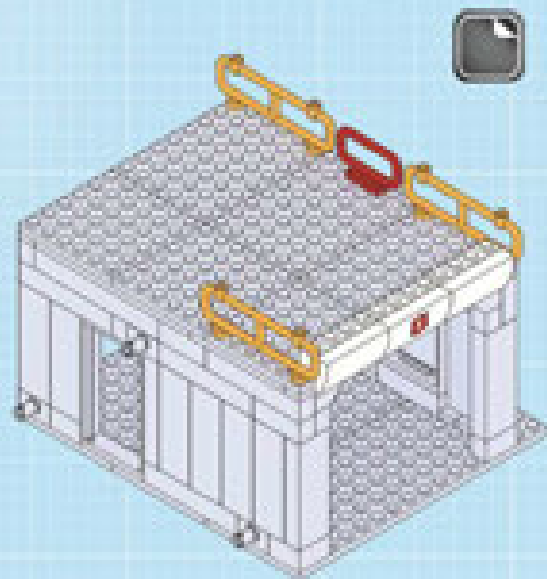
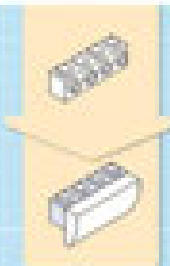

9

1x  1x  1x 



+

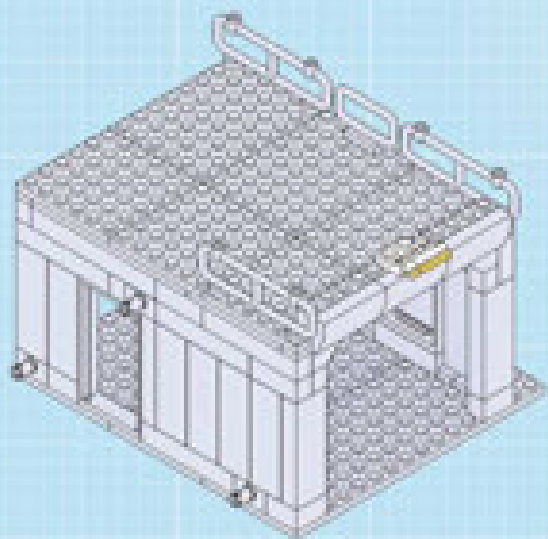

10



3x

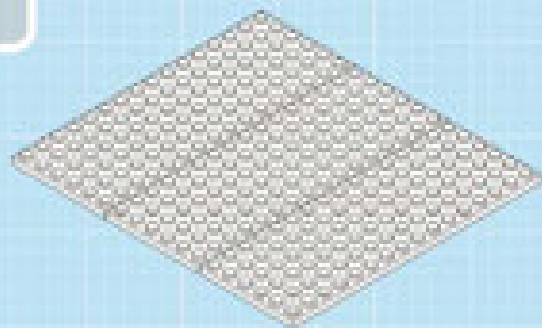

11



12

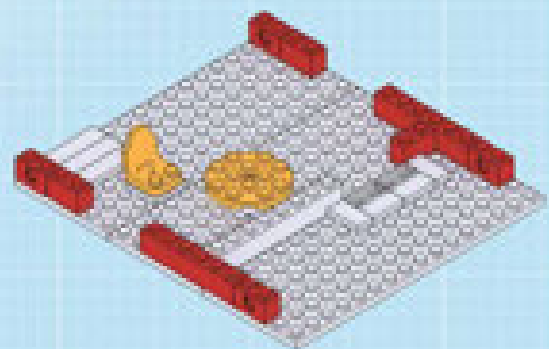
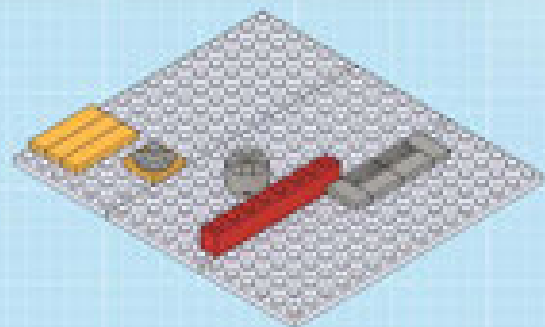

13

1x 1x 1x

5x 2x 1x 1x

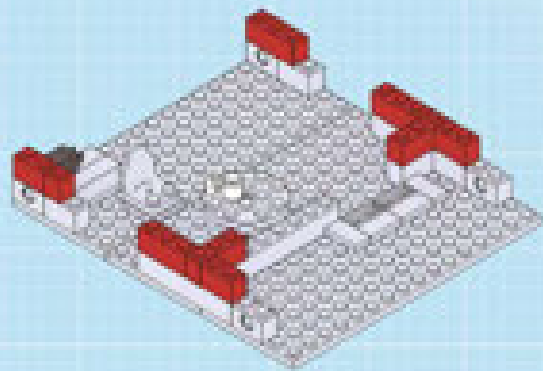

14

3x 2x 2x 2x 1x 2x

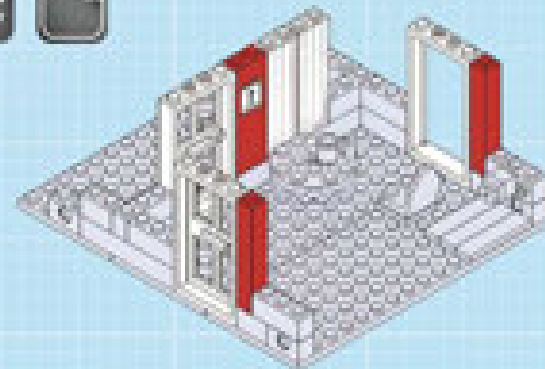
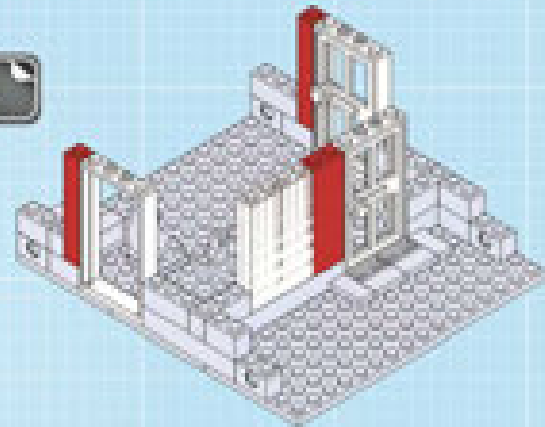
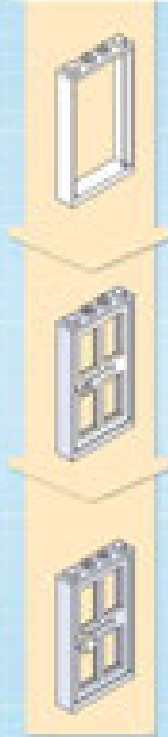

15

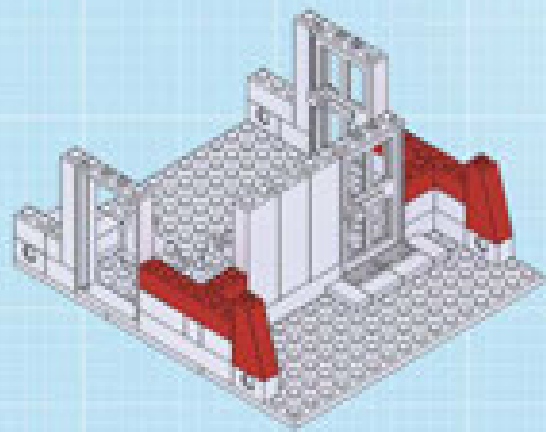

16

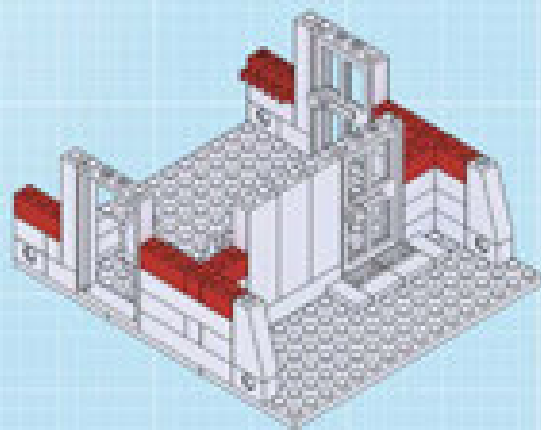

17

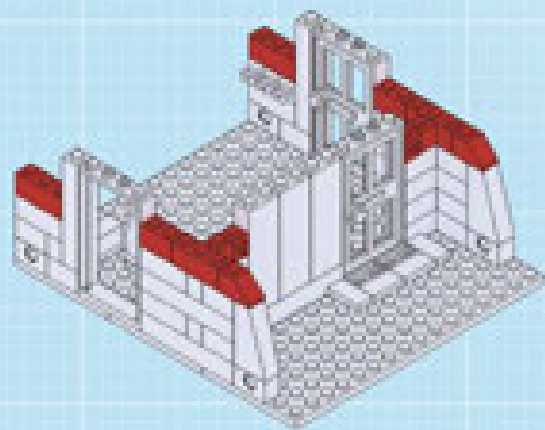

18

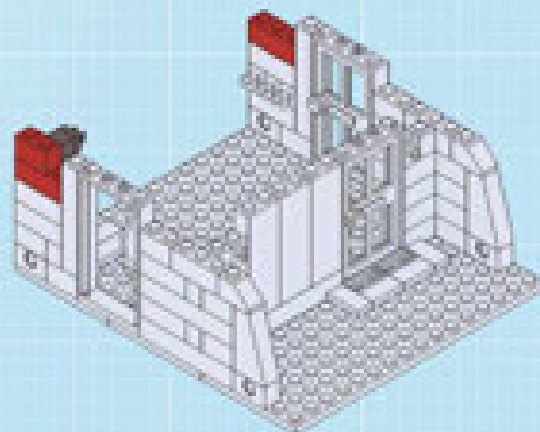

19

2x  2x  2x  2x 



20

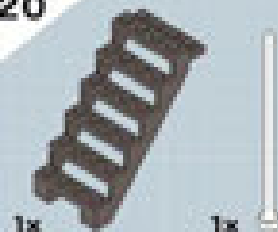

1x

1x

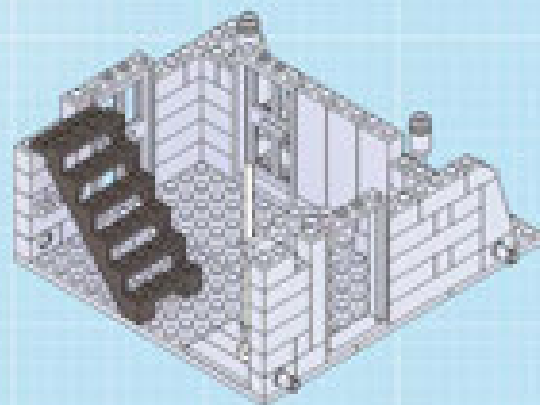
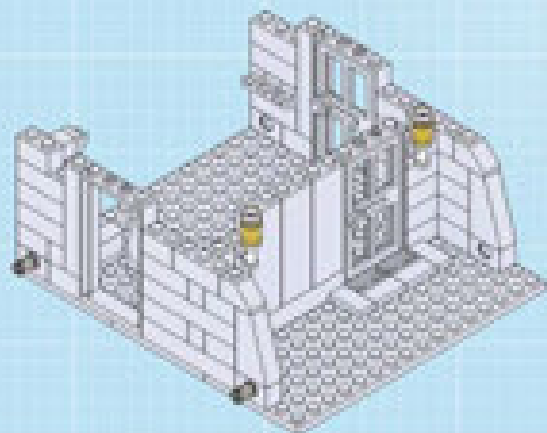

21

- 1x 
- 5x 
- 2x 
- 1x 

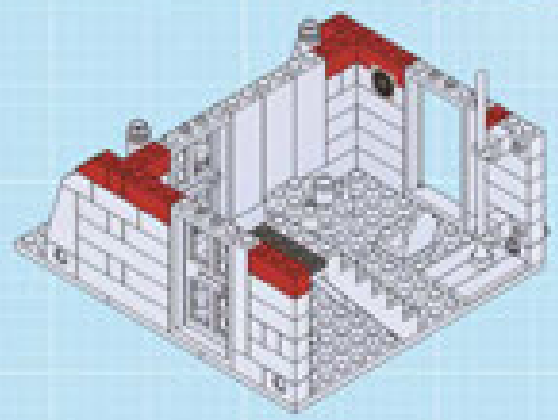
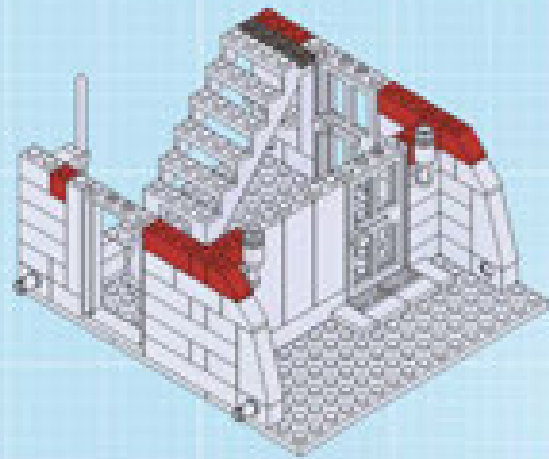

22

- 3x 
- 2x 
- 1x 
- 1x 
- 2x 
- 1x 

- 1x 
- 1x 
- 1x 
- 2x 

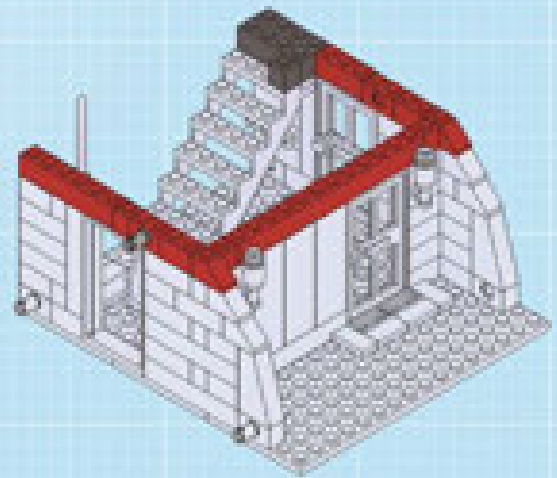

23



24

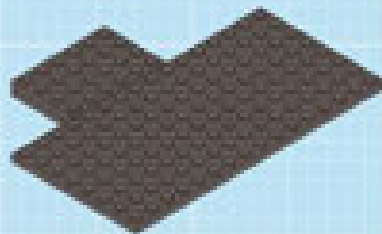
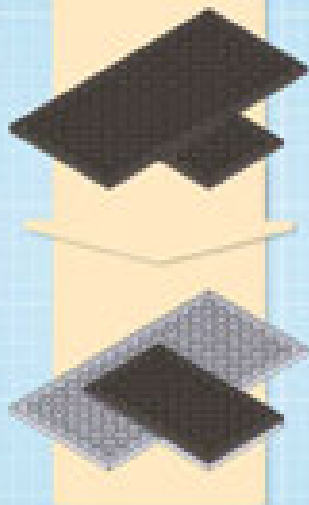
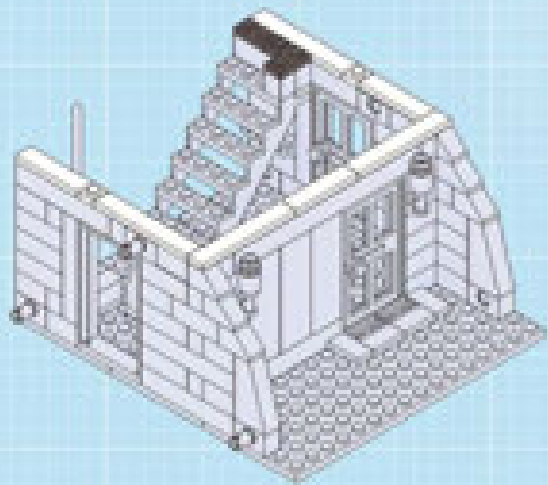
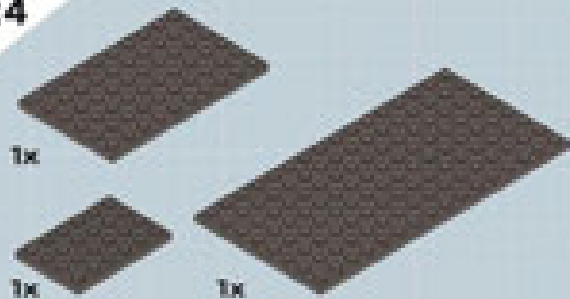

25

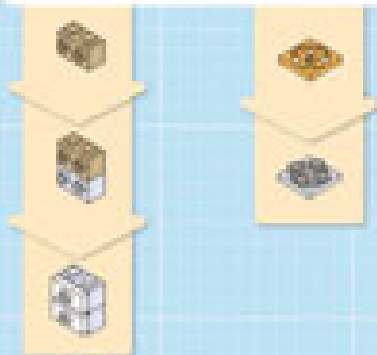

26

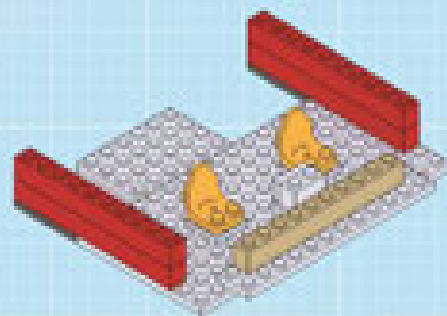
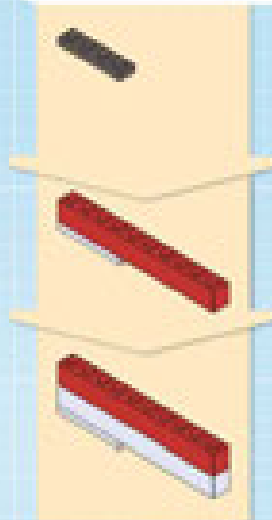

27

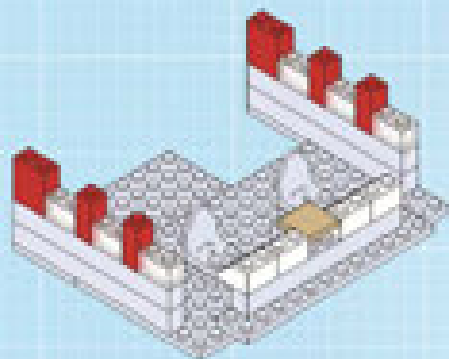

28

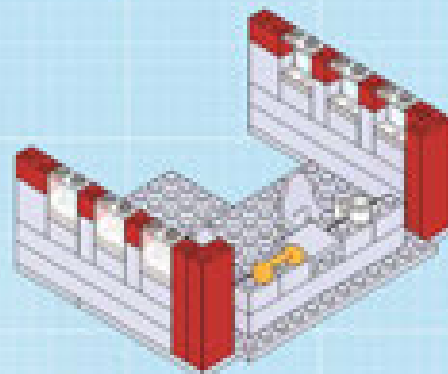

29

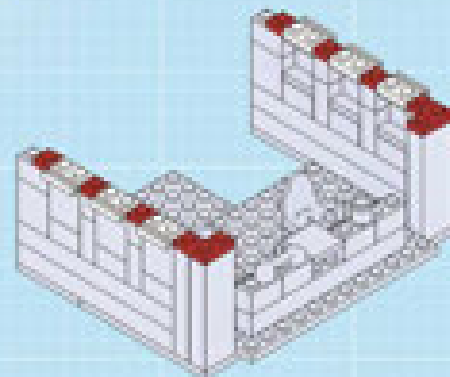
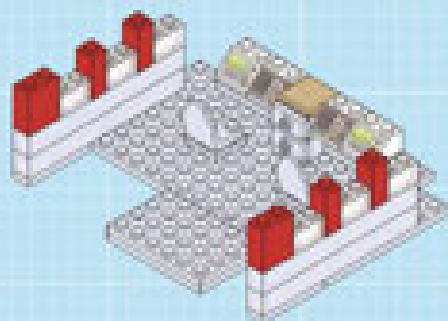

30



31

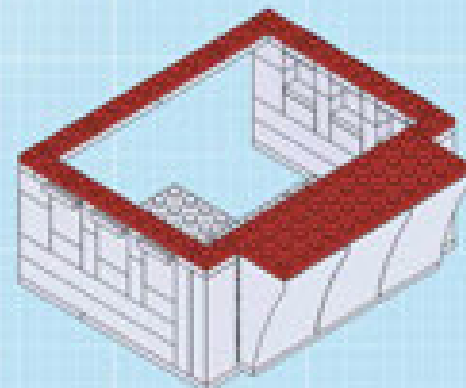
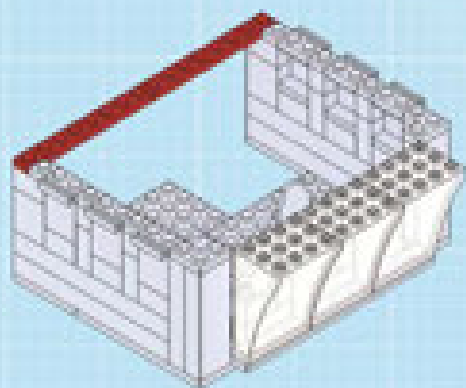

32

4x  3x 

2x  6x 

33

2x  4x 

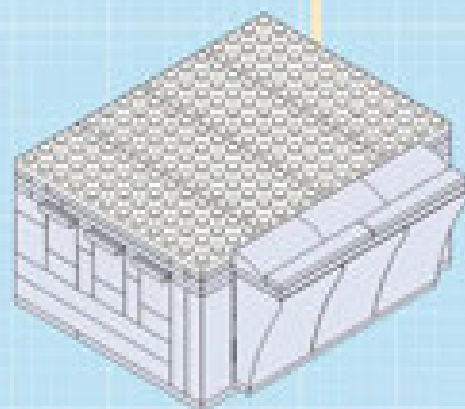
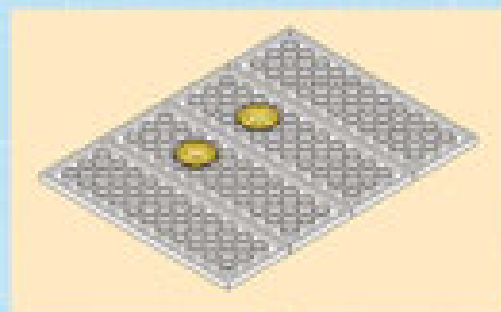
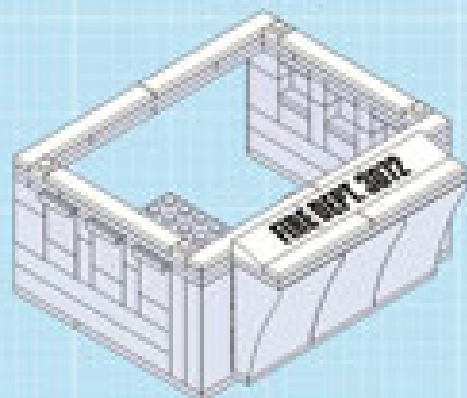

34



35

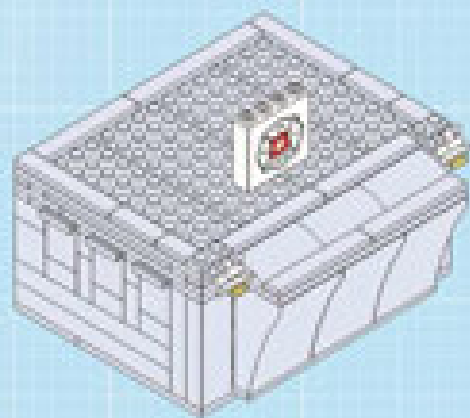
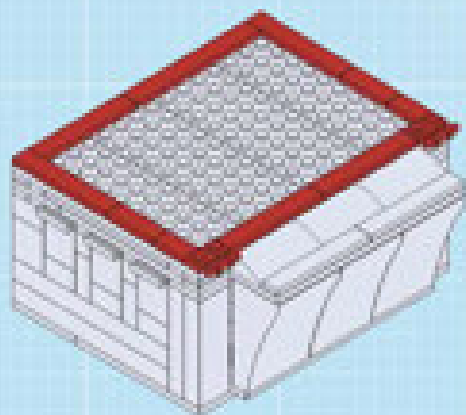

36

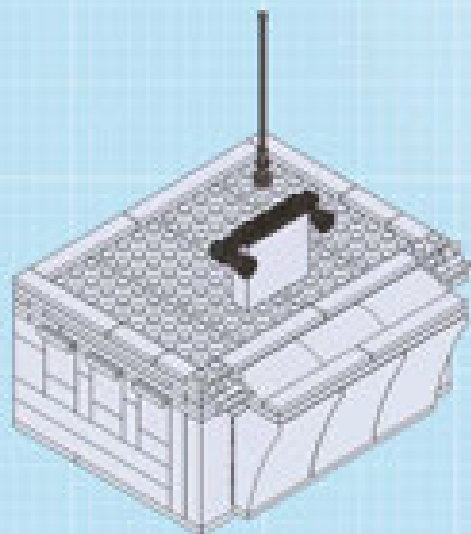

18

37



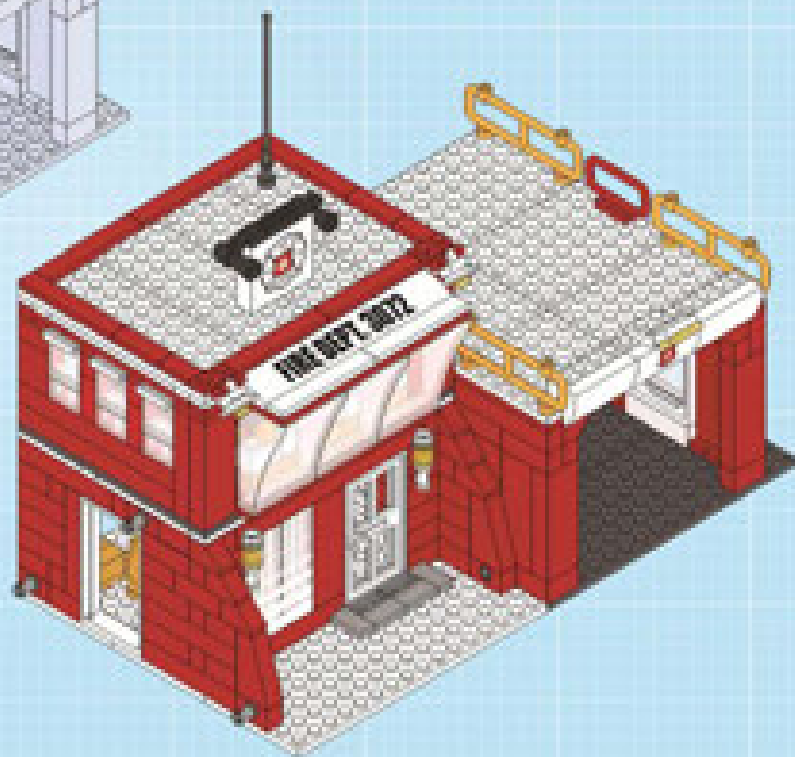

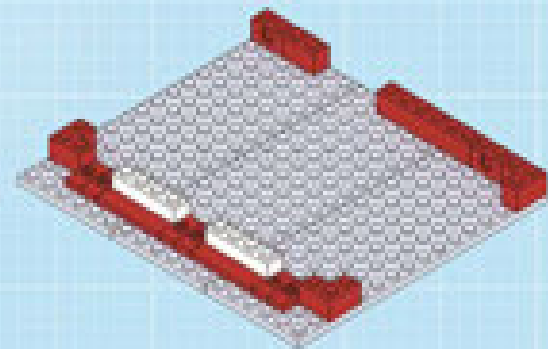
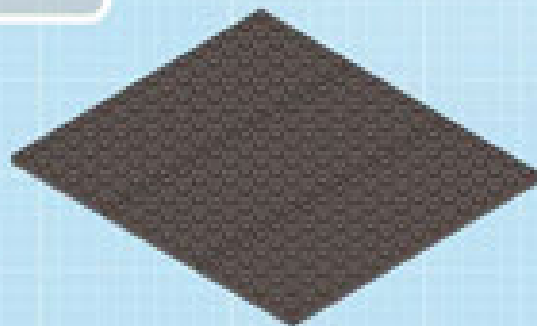
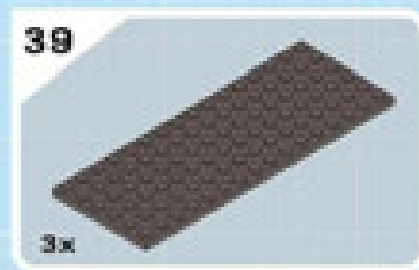
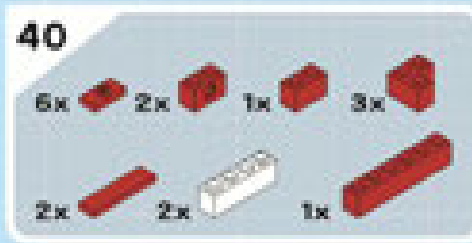
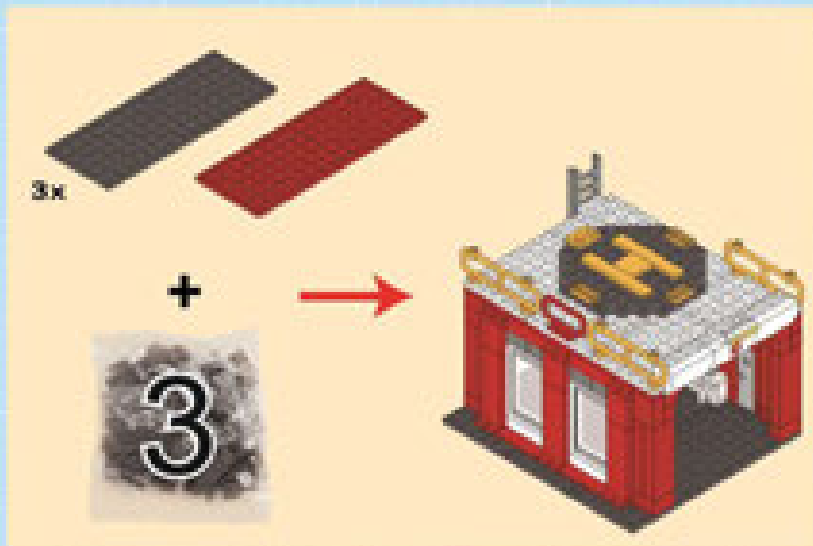

41

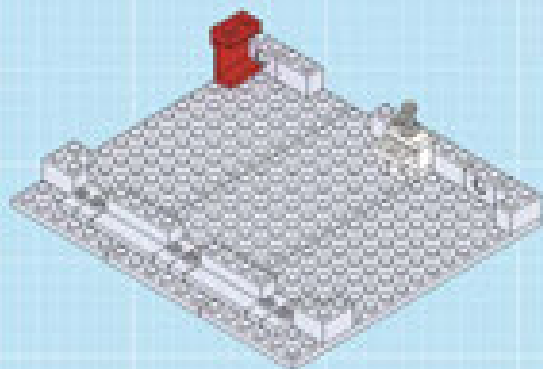

42

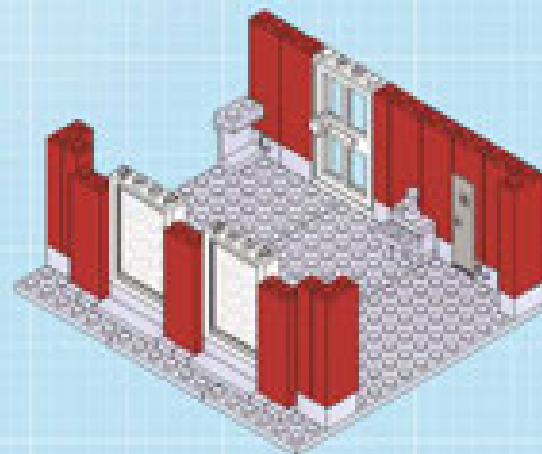
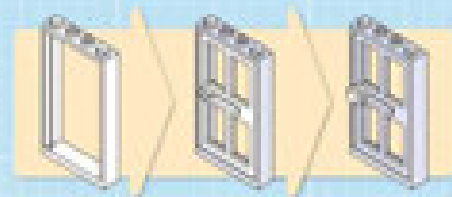
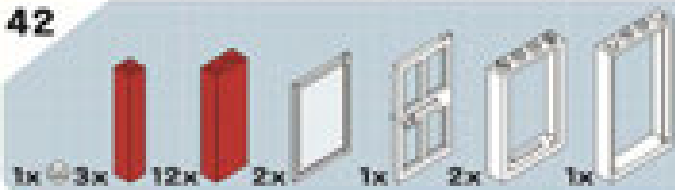

43

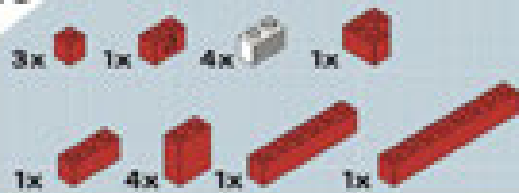

44

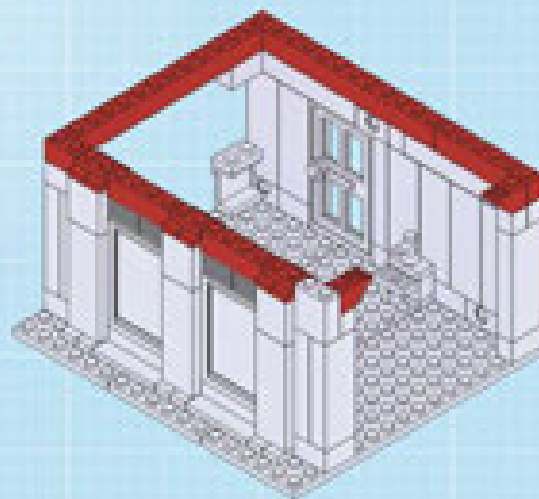
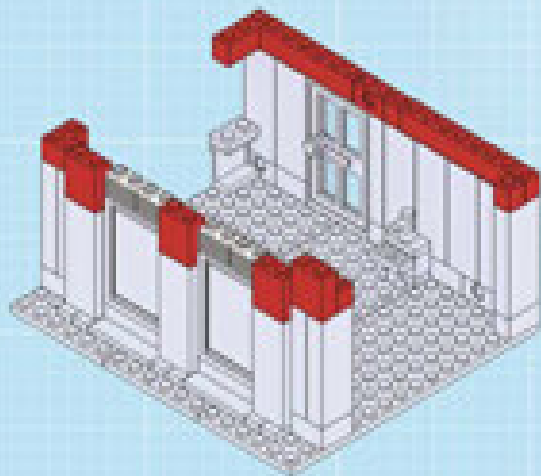

45

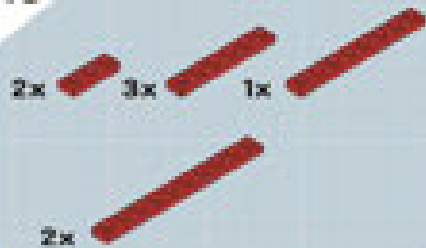

46

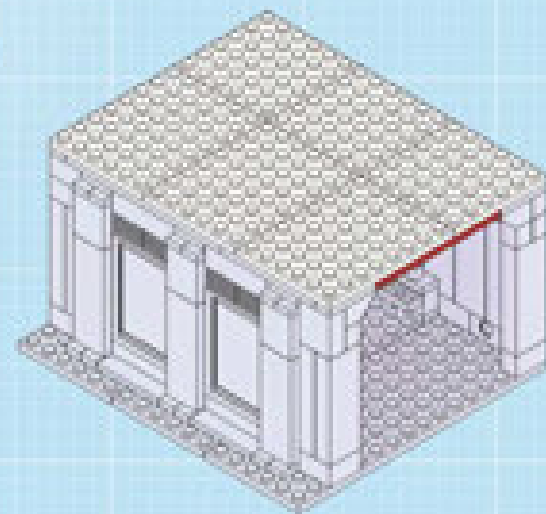
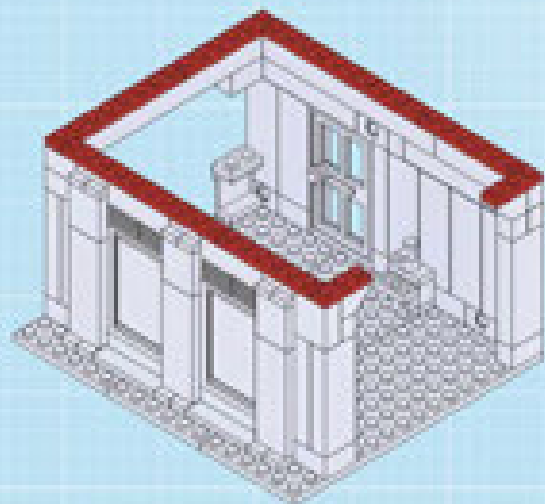
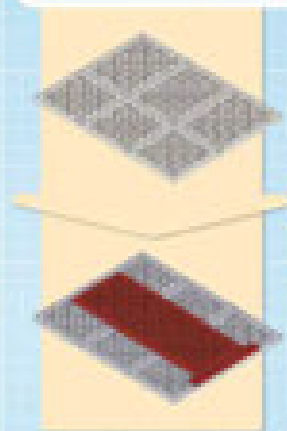

47

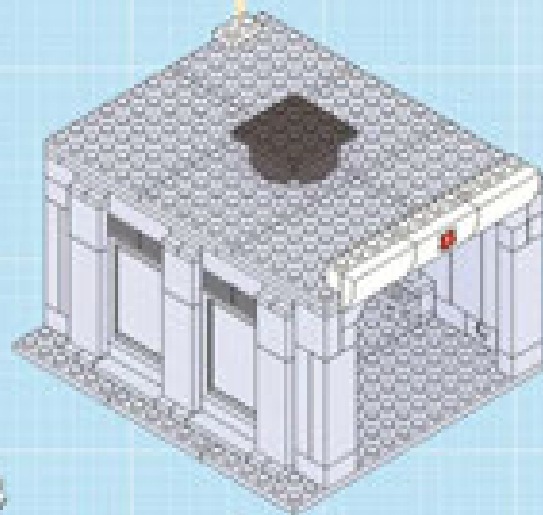
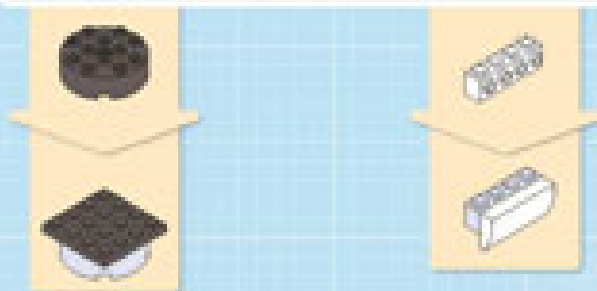

48

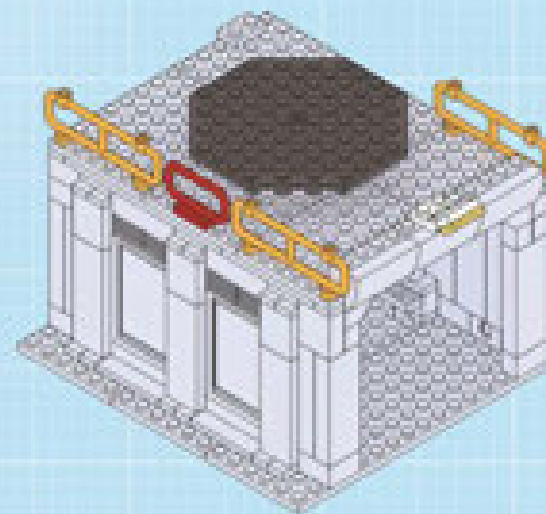

49

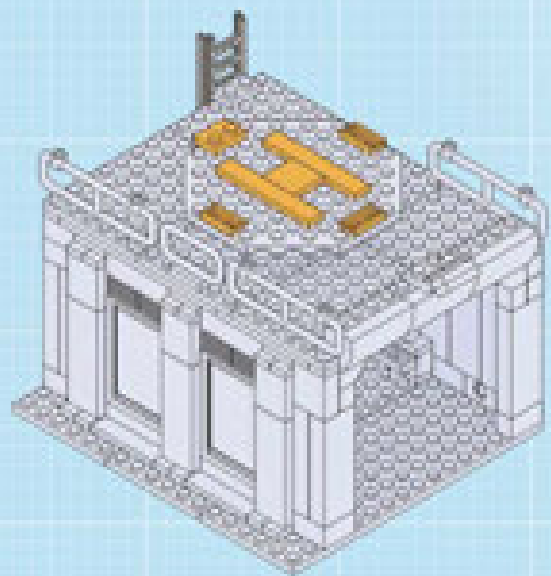

50

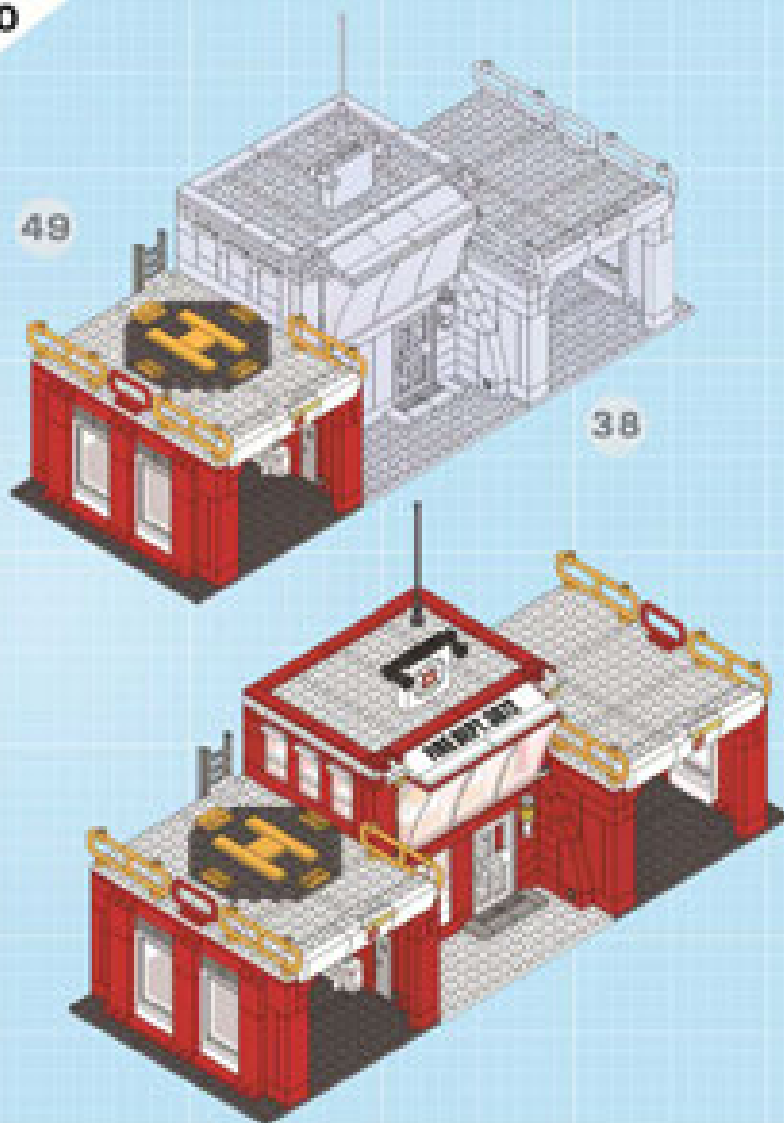



+



53

2x



2x



1x



51

4x



2x



1x



54

8x



1x



1x



1x



4x

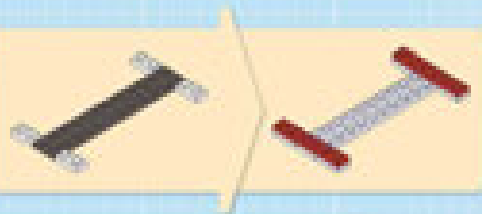

52

2x



4x



1x



55



57



58

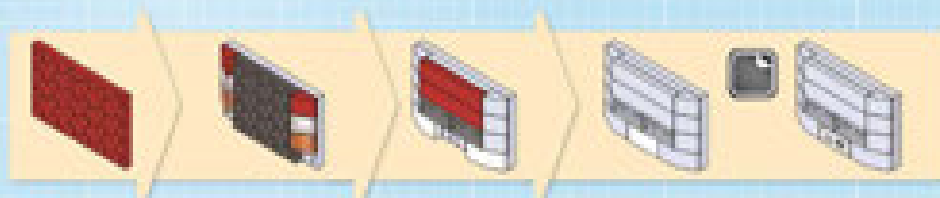

56

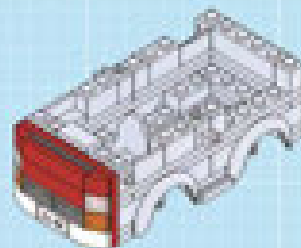
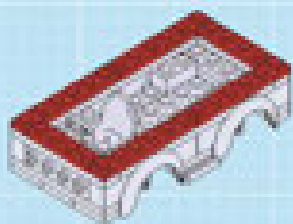

59



61

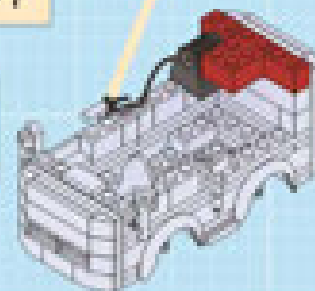

60

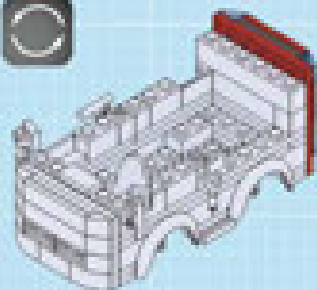
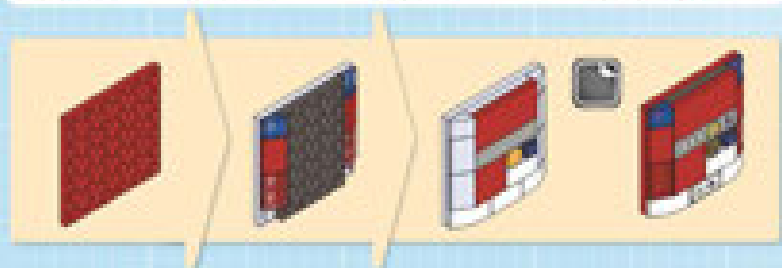

62



63

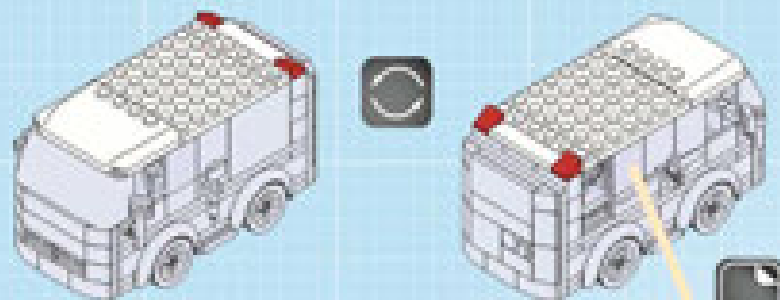

64

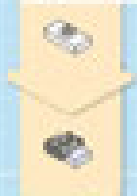

65



66

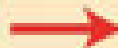

67



68



69



70

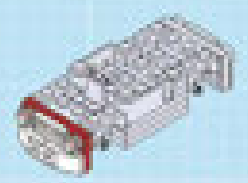
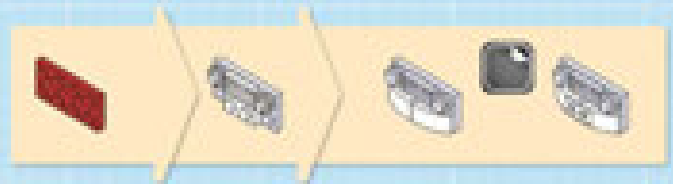

71

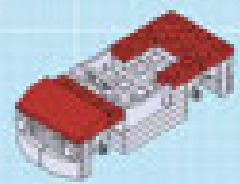

72



73



74

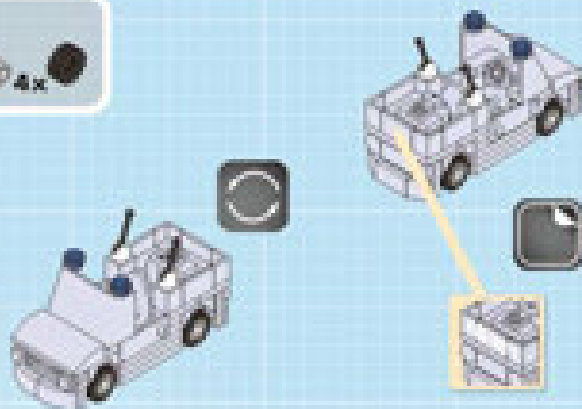
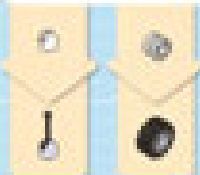

75



76

1x  1x  1x  1x 



77

1x  2x  1x 



78

2x  1x  1x  1x 

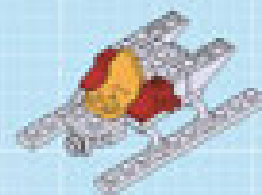

79

1x  1x  1x  1x  1x 



80

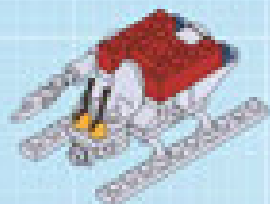

81



82

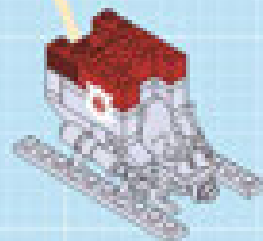
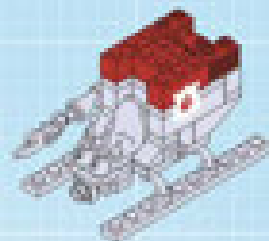

83

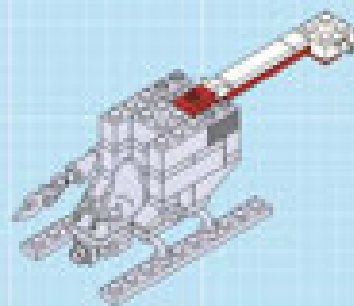
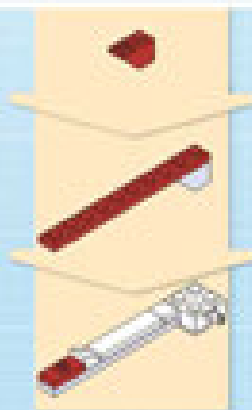

84

2x  1x 

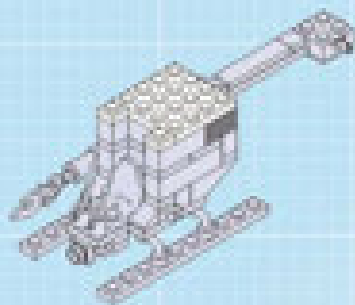

86

1x  1x  2x  1x  1x 

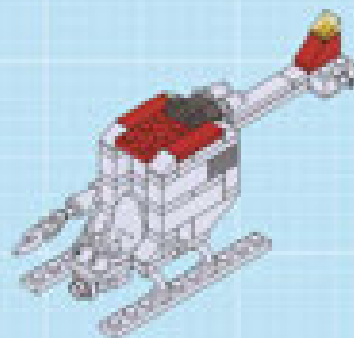

85

1x  1x  2x 
2x  1x  1x  1x 

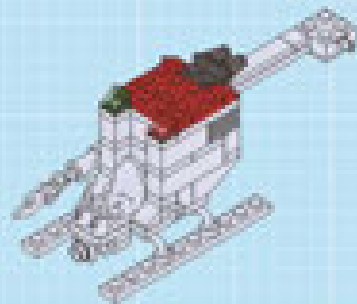

87

1x  1x  1x  1x 

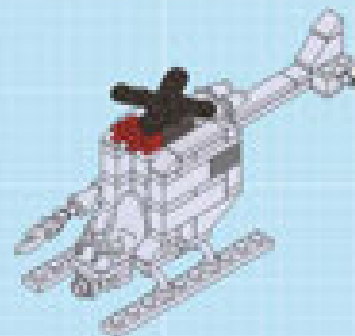

88

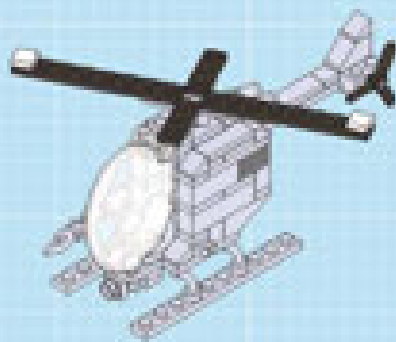

89



90



91

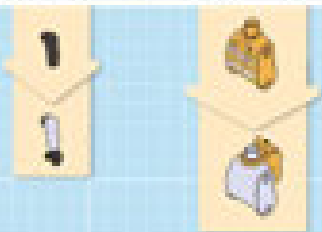

92

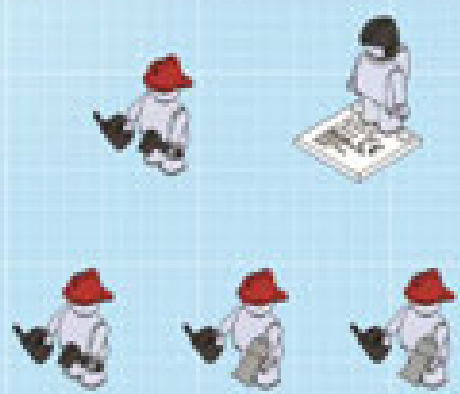
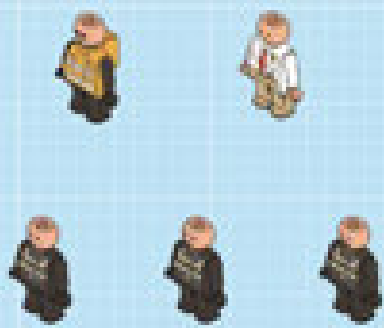

93

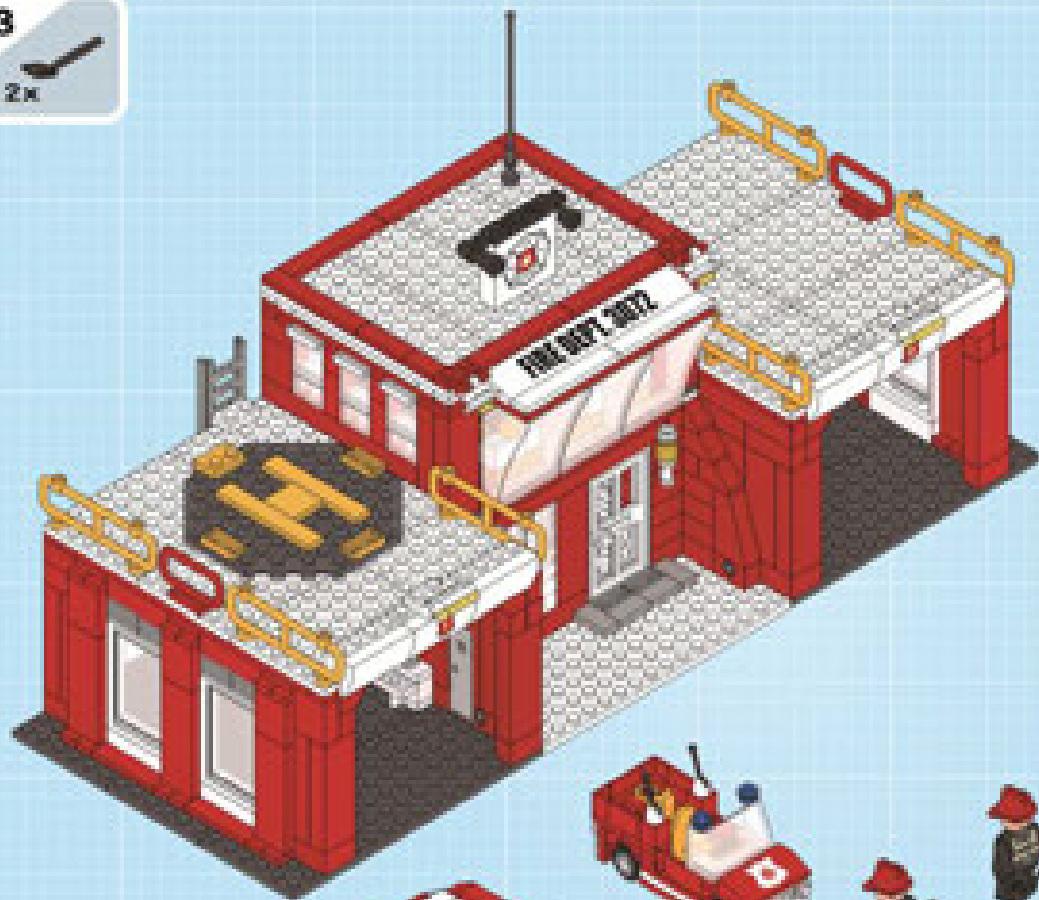

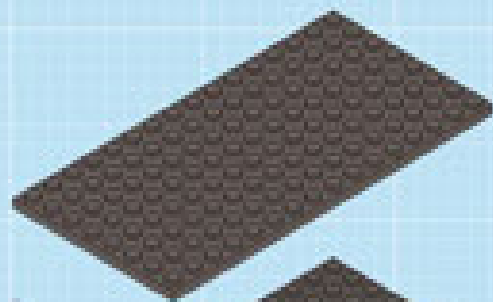

1x

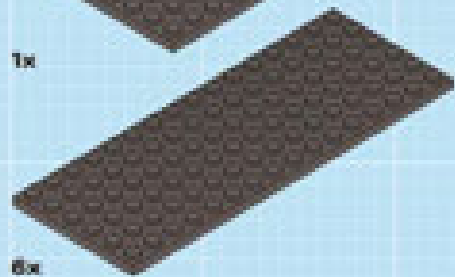

6x



1x



1x

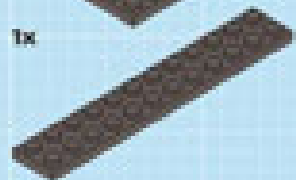

1x



2x



1x



2x



2x

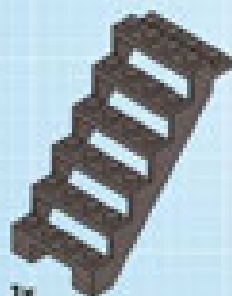

1x



2x



1x



2x



1x



3x



1x



1x



1x



4x



1x



1x



1x



1x



2x



2x



2x



1x



2x



1x



2x



1x



3x



4x



1x



4x



1x

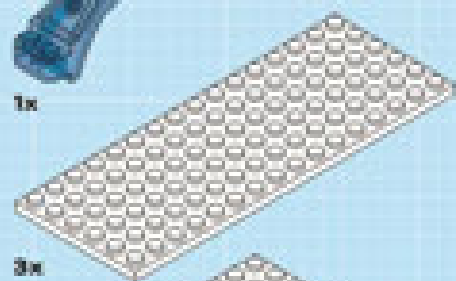

3x

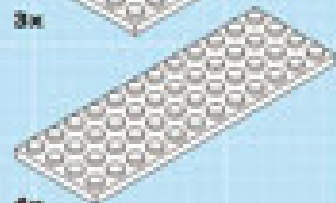

4x

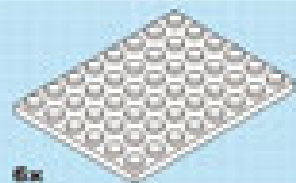

6x

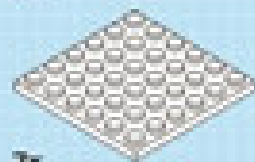

7x



6x



1x

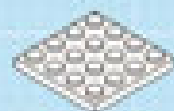

2x



5x

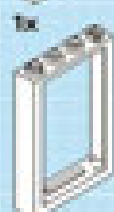

1x



8x



3x



1x



5x



2x



3x



8x



3x



2x



1x



1x

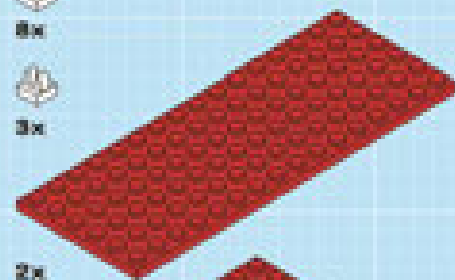

2x

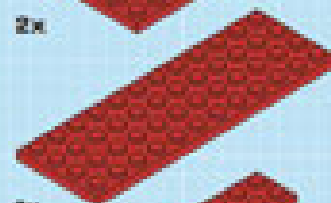

1x

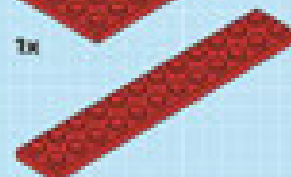

1x

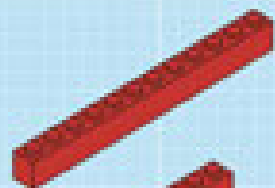

4x



4x



7x



3x

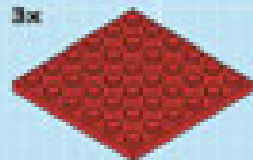

1x

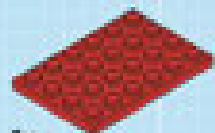

1x



1x



8x



1x



13x



15x



2x



8x



2x



5x



1x



2x



1x



8x



1x



2x



7x



1x



1x



14x



27x



2x



8x



3x



1x



1x



4x



2x



27x



10x



2x



6x



10x



2x



5x



2x



1x



1x



24x



12x



3x



2x



2x



8x



1x



13x



5x



2x



7x



4x



3x



28x



12x



4x



6x



2x



24x



5x



2x



2x

8x

8x

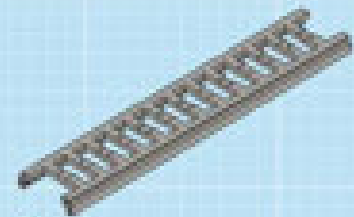

1x



1x



1x



1x



2x



1x



4x



5x



1x



6x



3x



1x

2x

