

MIRRORED CABINET VERONA



Mirrored Cabinet

Assembly instruction



Spiegelschrank

Montageanleitung



Armadietto con specchio

Istruzioni di assemblaggio

GB	Assembly, safety and warranty instructions Assembly steps	Page	7-8 14 -23
DE	Sicherheitshinweise, Garantie Zusammenbau	Seite	9-10 14 -23
IT	Indicazioni di sicurezza, garanzia Montaggio	Pagina	11-13 14 -23

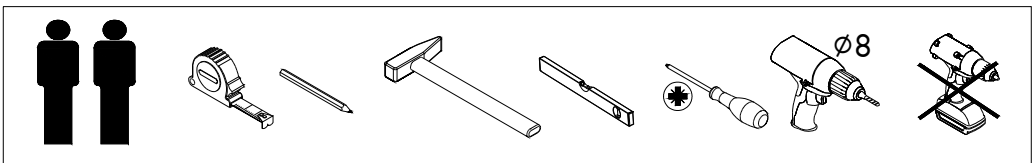
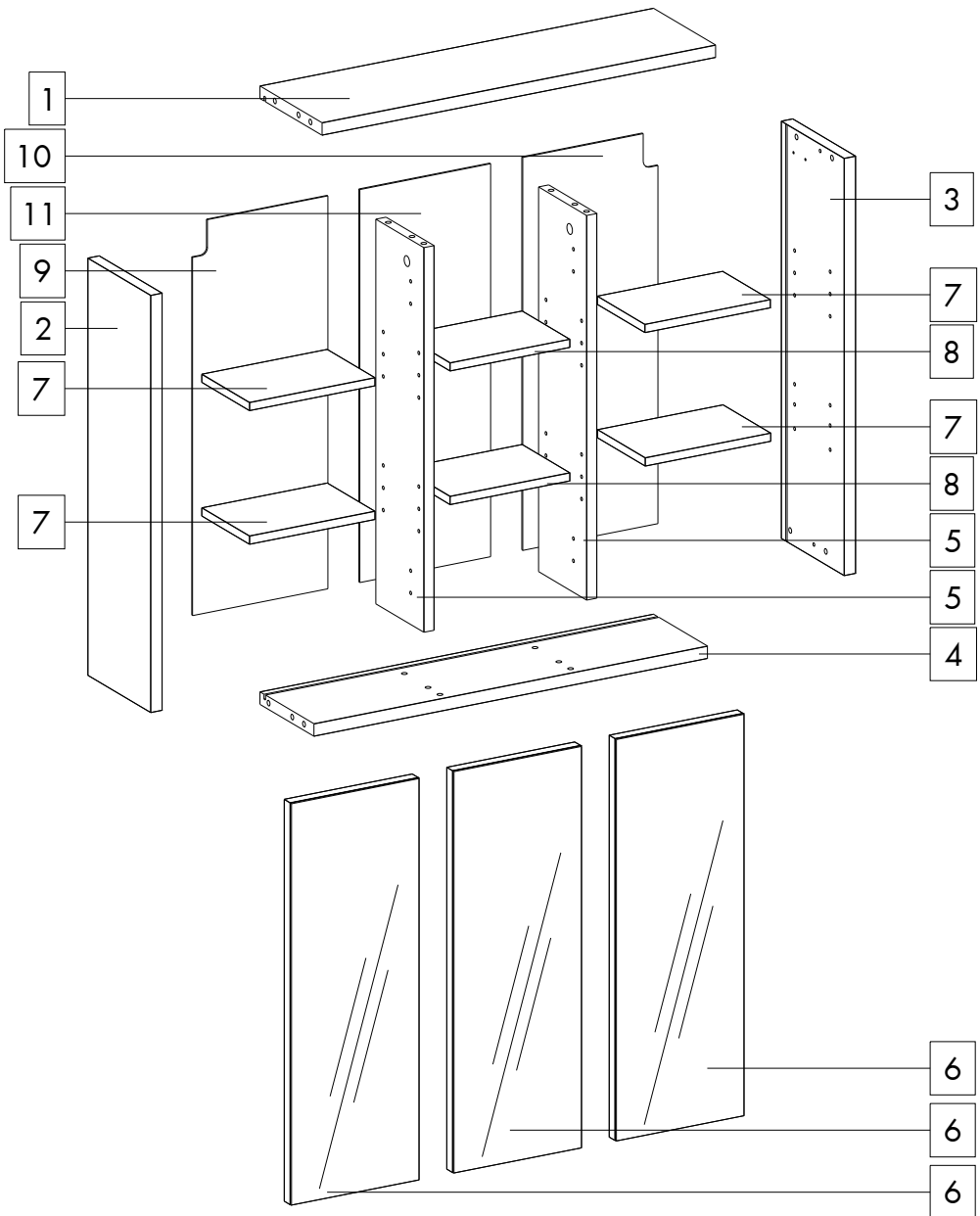

1



2

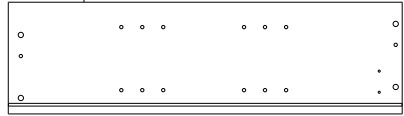

3

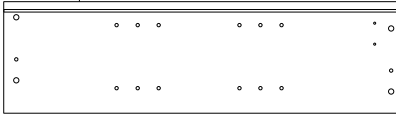

4

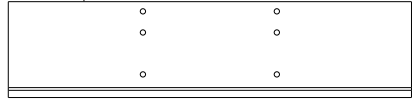

2x 5



3x 6



4x 7

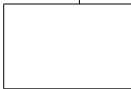

2x 8



9



10

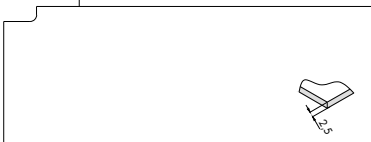

11

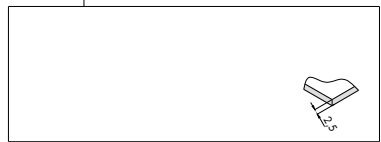

16x 12

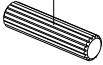

6x 13

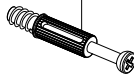

6x 14



2x 15

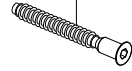

6x 16

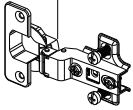

12x 17



2x 18



2x 19



4x 20



10x 21



4x 22



4x 23

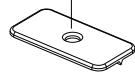

24x 24



4x 25



1x 26

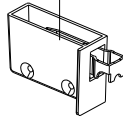

1x 27

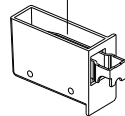

2x 28

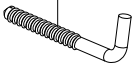

1x 29



2x 30



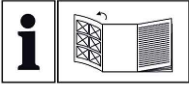

GB MT IE

Before reading, unfold the page containing the illustrations and familiarise yourself with all functions of the product.

DE AT CH

Klappen Sie vor dem Lesen die Seite mit den Abbildungen aus und machen Sie sich anschließend mit allen Funktionen des Produkts vertraut.

IT CH MT

Prima di proseguire con la lettura, consultare la pagina con le illustrazioni e familiarizzare poi con tutte le funzioni del prodotto.

Congratulations!

You have chosen a high-quality product. The operating instructions are part of this product. They contain important information about safety, usage and disposal. Before using the product, please familiarise yourself with all operating and safety instructions. Use the product only as described and for the range of applications specified. Please also pass these operating instructions on to any future owner.

Intended use

This product is intended solely for private use and not for commercial purposes. The warranty shall be deemed void in cases of misuse or improper handling, use of force and modifications / repairs which have not been carried out by one of our authorised Service centres.

Safety instructions

Warning: Please follow directly the manufacturer assembly instruction. Deficient assembly causes safety risks. Please check if the surface is appropriate and choose appropriate fasteners. Assembling by qualified personnel is recommended.

Warning! Furniture consists small parts.

Warning! Children under 3 years shall not be unattended.

Wall fixing /ANTI-TOPPLE WARNING

This product has to be permanently fixed to the wall with the bracket(s) included, to avoid fatal injury in case it topples over. In case of connective devices for the wall mounting, the supporting material must be checked for suitability.

Care instructions

Please do only clean with a duster or a damp cloth.

Do not use any scouring agents!



Warranty

Dear customer, this appliance comes with a 3-year warranty valid from the date of purchase. In the event that this product has any defects, you, the buyer, have certain statutory rights. Your statutory rights are not limited in any way by the warranty described below.

Warranty conditions

The warranty period starts on the date of purchase. Please keep your receipt in a safe place. This will be required as proof of purchase. If any material or manufacturing fault occurs within 3 years of the product's date of purchase, we will either repair or replace the product for you or refund the purchase price (at our discretion). This warranty service requires that you present the defective appliance and the proof of purchase (receipt) within the 3-year warranty period, together with a brief written description of the fault and of when it occurred. If the defect is covered by the warranty, your product will either be repaired or replaced by us. The repair or replacement of a product does not signify the beginning of a new warranty period.

Warranty period and statutory claims for defects

The warranty period is not prolonged by repairs effected under the warranty. This also applies to replaced and repaired components. Any damage and defects present at the time of purchase must be reported immediately after unpacking. Repairs carried out after expiry of the warranty period shall be subject to a fee.

Scope of the warranty

This appliance has been manufactured in accordance with strict quality guidelines and inspected meticulously prior to delivery. The warranty covers material faults or production faults. The warranty does not extend to product parts subject to normal wear and tear or to fragile parts which could be considered as consumable parts such as switches or parts made of glass. The warranty does not apply if the product has been damaged, improperly used or improperly maintained. The directions in the operating instructions for the product regarding proper use of the product are to be strictly followed. Uses and actions that are discouraged in the operating instructions or which are warned against must be avoided

Disposal

Please dispose packaging and product after use in an environmentally sound manner.

Herzlichen Glückwunsch!

Sie haben sich damit für ein hochwertiges Produkt entschieden. Die Bedienungsanleitung ist Teil dieses Produkts. Sie enthält wichtige Hinweise für Sicherheit, Gebrauch und Entsorgung. Machen Sie sich vor der Benutzung des Produkts mit allen Bedien- und Sicherheitshinweisen vertraut. Benutzen Sie das Produkt nur wie beschrieben und für die angegebenen Einsatzbereiche. Händigen Sie alle Unterlagen bei Weitergabe des Produkts an Dritte mit aus.

Bestimmungsgemäße Verwendung

Das Produkt ist lediglich für den privaten und nicht für den gewerblichen Gebrauch bestimmt. Bei missbräuchlicher und unsachgemäßer Behandlung, Gewaltanwendung und bei Eingriffen, die nicht von unserer autorisierten Service-Niederlassung vorgenommen wurden, erlischt die Garantie.

Sicherheitshinweis

Achtung: Die Montage muss exakt nach den Anweisungen des Herstellers erfolgen - anderenfalls kann eine fehlerhafte Montage zu einem Sicherheitsrisiko führen. Bei mangelhafter Montage besteht Gefahr für die Sicherheit. Prüfen Sie bitte den Untergrund auf Eignung und wählen Sie geeignete Befestigungsmittel. Aufbau durch fachkundiges Personal empfohlen!

Achtung! Möbel enthält verschluckbare Kleinteile.

Achtung! Kinder < 3 Jahre nicht ohne Beaufsichtigung lassen.

Wandmontage

WARNHINWEIS: Um ein Umkippen zu verhindern, ist dieses Produkt mit dem mitgelieferten Schrankaufhänger zu verwenden. Bei Verbindungsmittel für die Wandbefestigung ist das Trägermaterial auf Eignung zu prüfen.

Pflegehinweis

Bitte nur mit einem Staubtuch oder einem feuchten Lappen reinigen. Keine scheuernden Putzmittel verwenden!

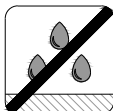

Garantiezeit und gesetzliche Mängelansprüche

Die Garantiezeit wird durch die Gewährleistung nicht verlängert. Dies gilt auch für ersetzte und reparierte Teile. Eventuell schon beim Kauf vorhandene Schäden und Mängel müssen sofort nach dem Auspacken gemeldet werden. Nach Ablauf der Garantiezeit anfallende Reparaturen sind kostenpflichtig.

Garantieumfang

Das Produkt wurde nach strengen Qualitätsrichtlinien sorgfältig produziert und vor Anlieferung gewissenhaft geprüft. Die Garantieleistung gilt für Material- oder Fabrikationsfehler. Diese Garantie erstreckt sich nicht auf Produktteile, die normaler Abnutzung ausgesetzt sind und daher als Verschleißteile angesehen werden können oder für Beschädigungen an zerbrechlichen Teilen, z. B. Schalter, oder Teile, die aus Glas gefertigt sind. Diese Garantie verfällt, wenn das Produkt beschädigt, nicht sachgemäß benutzt oder gewartet wurde. Für eine sachgemäße Benutzung des Produkts sind alle in der Bedienungsanleitung aufgeführten Anweisungen genau einzuhalten. Verwendungszwecke und Handlungen, von denen in der Bedienungsanleitung abgeraten oder vor denen gewarnt wird, sind unbedingt zu vermeiden.

Garantie

Sehr geehrte Kundin,
sehr geehrter Kunde, Sie erhalten auf dieses Produkt 3 Jahre Garantie ab Kaufdatum. Im Falle von Mängeln dieses Produkts stehen Ihnen gegen den Verkäufer des Produkts gesetzliche Rechte zu. Diese gesetzlichen Rechte werden durch unsere im Folgenden dargestellte Garantie nicht eingeschränkt.

Garantiebedingungen

Die Garantiefrist beginnt mit dem Kaufdatum. Bitte bewahren Sie den Original Kassenbon gut auf. Dieser wird als Nachweis für den Kauf benötigt. Tritt innerhalb von drei Jahren ab dem Kaufdatum dieses Produkts ein Material- oder Fabrikationsfehler auf, wird das Produkt von uns - nach unserer Wahl - für Sie kostenlos repariert, ersetzt, oder der Kaufpreis erstattet. Diese Garantieleistung setzt voraus, dass innerhalb der Drei-Jahres-Frist das defekte Produkt und der Kaufbeleg (Kassenbon) vorgelegt und schriftlich kurz beschrieben wird, worin der Mangel besteht und wann er aufgetreten ist. Wenn der Defekt von unserer Garantie gedeckt ist, erhalten Sie das reparierte oder ein neues Produkt zurück. Mit Reparatur oder Austausch des Produkts beginnt kein neuer Garantiezeitraum.

Entsorgung

Bitte entsorgen Sie Verpackung und Produkt nach der Verwendung umweltgerecht.

Auguri!

Con il presente acquisto avete scelto un prodotto di qualità. Le istruzioni d'uso sono parte integrante del prodotto. Esse contengono informazioni importanti circa la sicurezza, l'uso e lo smaltimento. Prima di utilizzare il prodotto, familiarizzare con tutte le indicazioni d'uso e di sicurezza del prodotto. Utilizzare il prodotto solo come descritto e secondo gli ambiti d'impiego indicati. In caso di cessione del prodotto a terzi, consegnare anche tutta la documentazione.

Utilizzo conforme

Il prodotto è destinato esclusivamente all'uso privato e non commerciale. In caso di uso errato o non conforme, uso della forza e interventi, che non sono stati effettuati dalla nostra filiale d'assistenza autorizzata, la garanzia decade.

Indicazioni di sicurezza

Attenzione: Il montaggio deve essere svolto esattamente come descritto dalle indicazioni del produttore; in caso contrario, un montaggio scorretto può determinare un rischio di sicurezza. In caso di montaggio errato, sussiste un rischio per la sicurezza. Verificare se la superficie è appropriata e scegliere i dispositivi di fissaggio appropriati.

Si consiglia di fare svolgere il montaggio a personale esperto!

Avvertimento! I mobili sono costituiti da piccole parti.

Avvertimento! I bambini sotto i 3 anni non devono essere incustoditi.

Montaggio a parete

AVVISO DI PERICOLO: Per evitarne il ribaltamento, il presente prodotto è fornito con un gancio per armadio. In caso di fissaggio a parete, verificare la tenuta del materiale portante.

Indicazioni per la cura

Pulire esclusivamente con un panno per polvere o un panno umido. Non utilizzare detersivi abrasivi!



Periodo di garanzia e richieste legali di garanzia

Il periodo di garanzia non viene prolungato dalle prestazioni in garanzia. Lo stesso si applica a parti sostituite o riparate. I danni o difetti presenti già all'acquisto devono essere comunicati immediatamente dopo l'apertura dell'imballaggio. I costi delle riparazioni svolte dopo la decorrenza del periodo garanzia sono a carico del consumatore.

Livello di garanzia

Il prodotto è stato accuratamente realizzato secondo rigidi criteri di qualità e coscienziosamente testato prima della consegna. Le prestazioni di garanzia coprono gli errori di materiale e di fabbricazione. La garanzia non copre le parti di prodotto soggette ad usura normale, che, pertanto, sono considerate pezzi soggetti ad usura, o il danneggiamento di parti delicate, come interruttori o parti di vetro. La garanzia decade in caso di danneggiamento del prodotto, uso non conforme o mancata manutenzione. Per un uso conforme è necessario rispettare con attenzione tutte le indicazioni contenute nel manuale d'uso. Gli scopi d'impiego e gli usi, che vengono sconsigliati o da cui si viene ammoniti nelle istruzioni per l'uso, devono essere evitati a tutti i costi.

Garanzia

Gentili clienti,

Il prodotto da voi acquistato è coperto da una garanzia triennale a decorrere dalla data d'acquisto. In caso di difetti di questo prodotto, vi sono garantiti dei diritti legali nei confronti del venditore del prodotto. Questi diritti legali non vengono limitati dalla nostra garanzia descritta al seguito.

Condizioni di garanzia

Il periodo di garanzia decorre dalla data d'acquisto. Si prega di conservare con cautela lo scontrino originale. Quest'ultimo è necessario per attestare l'acquisto. Se un difetto di materiale o di fabbricazione si verifica entro tre anni dalla data di acquisto di questo prodotto,

a nostra discrezione, ripareremo o sostituiremo il prodotto senza alcun costo per voi, o vi rimborseremo il prezzo di acquisto. Al fine di potere usufruire delle prestazioni di garanzia entro il periodo dei tre anni,

è necessario che il prodotto difettoso e lo scontrino fiscale vengano consegnati, unitamente a una breve descrizione in cui si indica il difetto e il momento in cui si è presentato. Se il difetto è coperto dalla nostra garanzia, provvederemo a restituirvi il prodotto riparato o un nuovo prodotto. La riparazione o la sostituzione del prodotto non determina la decorrenza di un nuovo periodo di garanzia.

La prestazione in garanzia vale per difetti del materiale o di fabbricazione.

Questa garanzia non si estende a componenti del prodotto esposti a normale

logorio, che possono pertanto essere considerati come componenti soggetti a usura (esempio capacità della batteria, calcificazione, lampade, pneumatici, filtri, spazzole...). La garanzia non si estende altresì a danni che si verificano su componenti delicati (esempio interruttori, batterie, parti realizzate in vetro, schermi, accessori vari) nonché danni derivanti dal trasporto o altri incidenti.

Smaltimento

Al termine del loro utilizzo, il prodotto e l'imballaggio devono essere smaltiti secondo le norme ambientali.

A



8x12



6x13



4x14



8x24

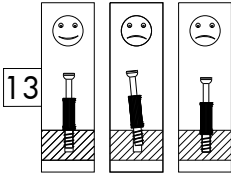
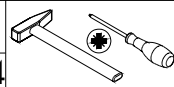

13

1

12

14

13

13

14

14

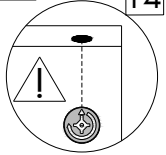

12

13

24

24

13

2

13

24

24

24

24

13

3

13

24

24

24

24

13

14

4

14

12

12

B

8x12



2x14

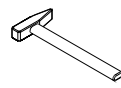

16x24

**2x** 5

12

24

24

24

24

14

12

24

24

24

24

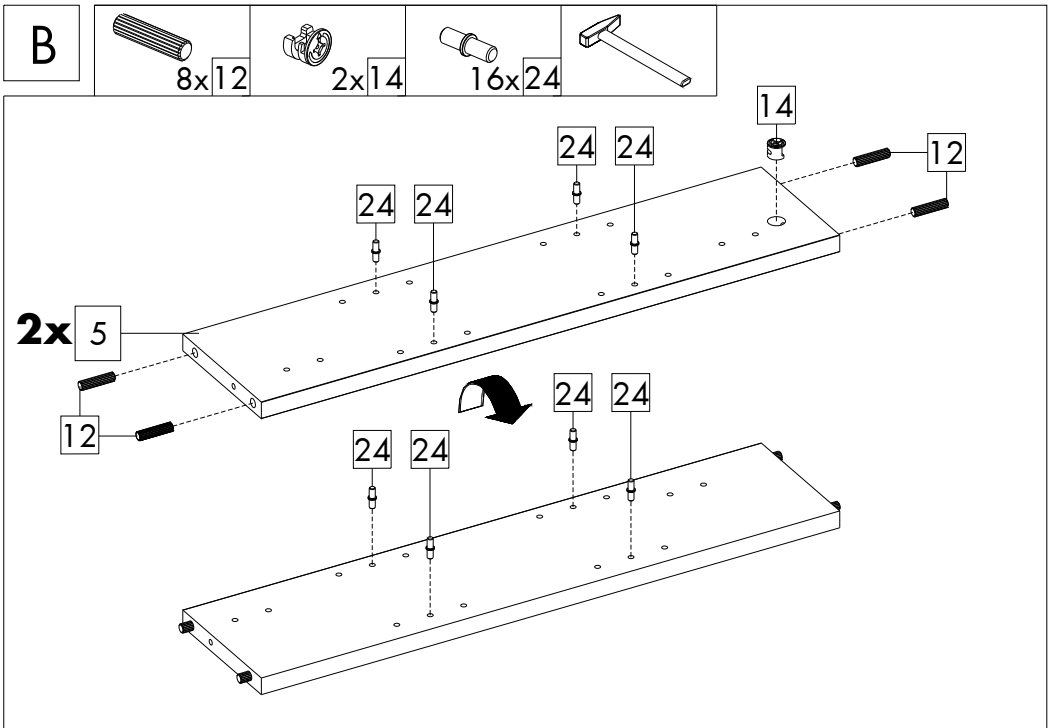
**C**

2x15



2x18



2x19



1x29



1

18

18

5

5

15

15

29

19

4

19

19

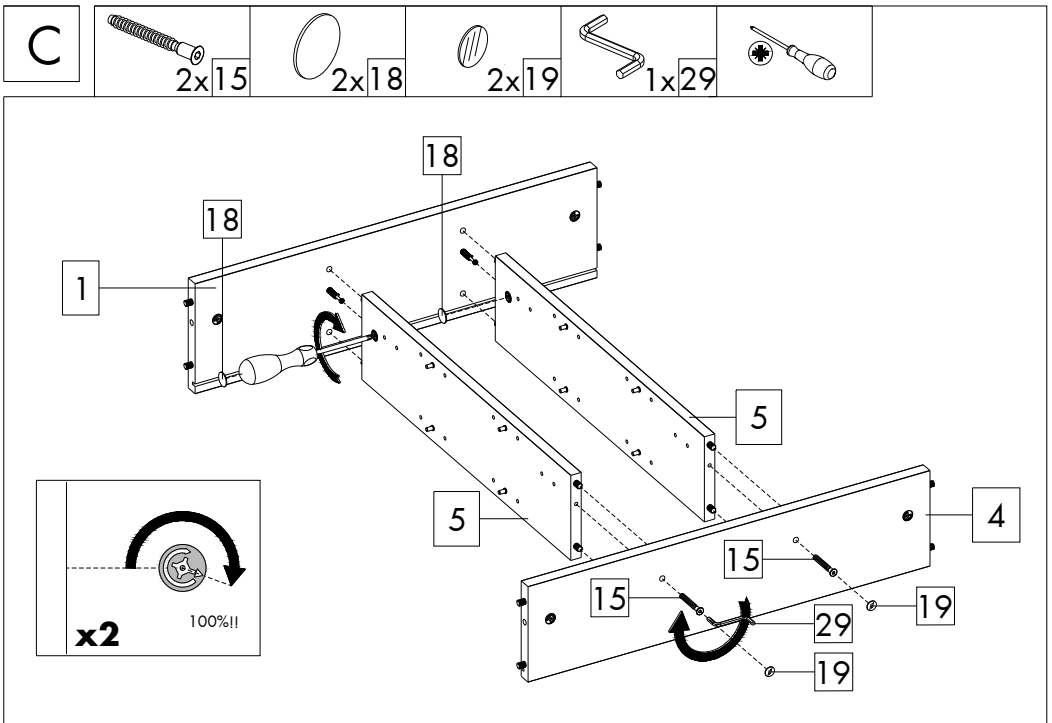
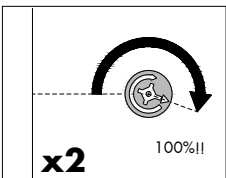

D

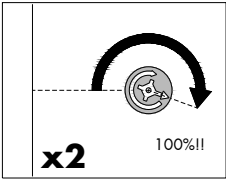
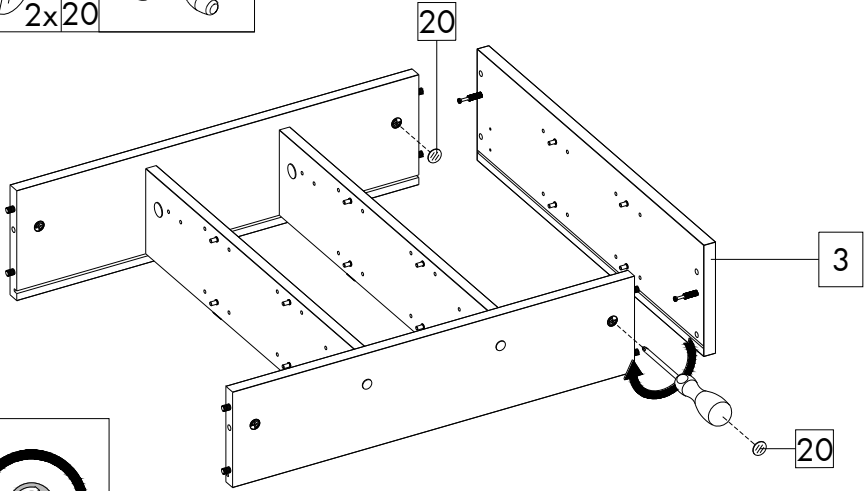
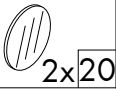

E

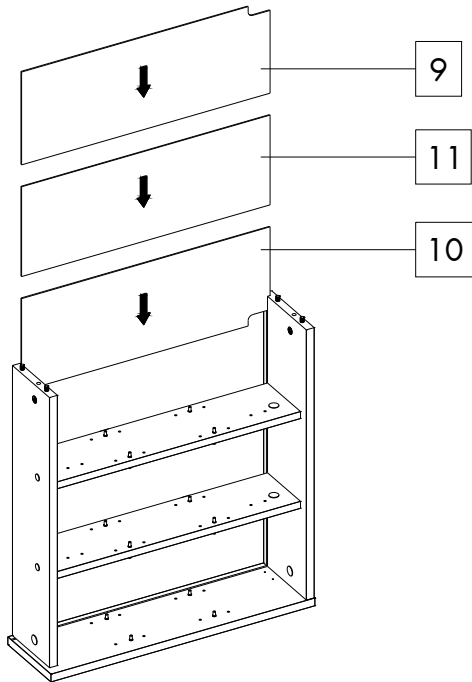

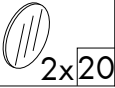
F

2

20

20

x2

100%II

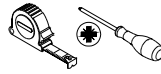
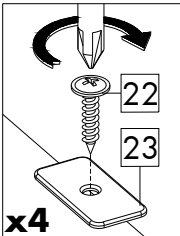
G**x10**

! $XX=YY=90^\circ$

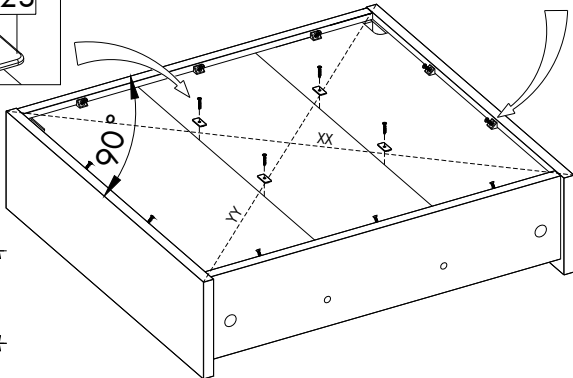
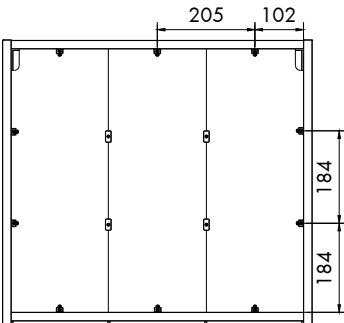
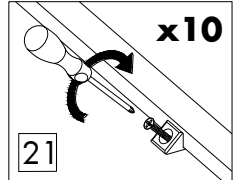

H

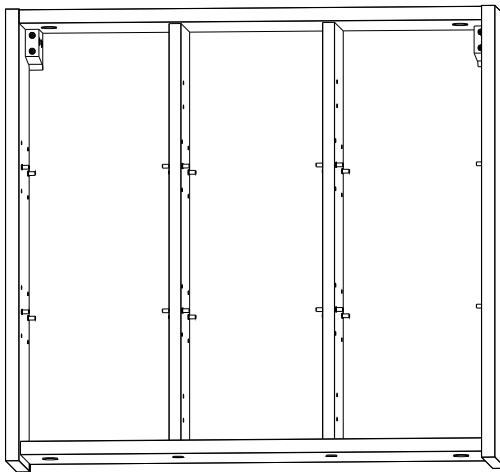
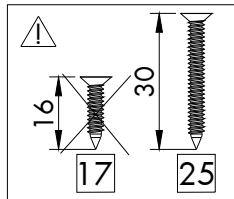
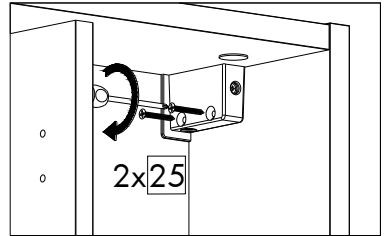
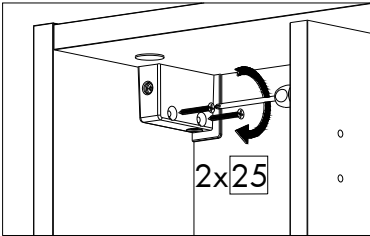
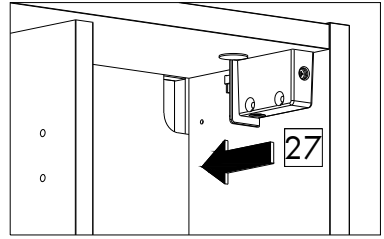
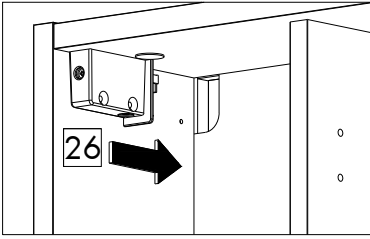
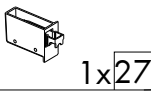
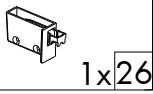
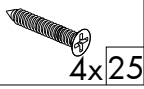

I

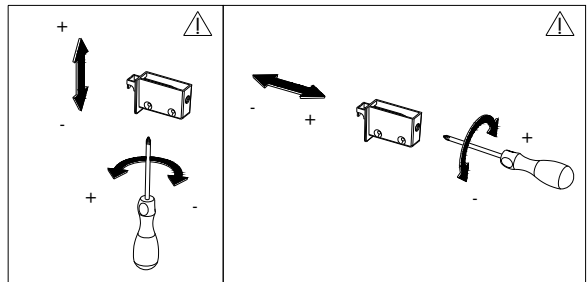
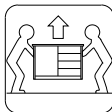
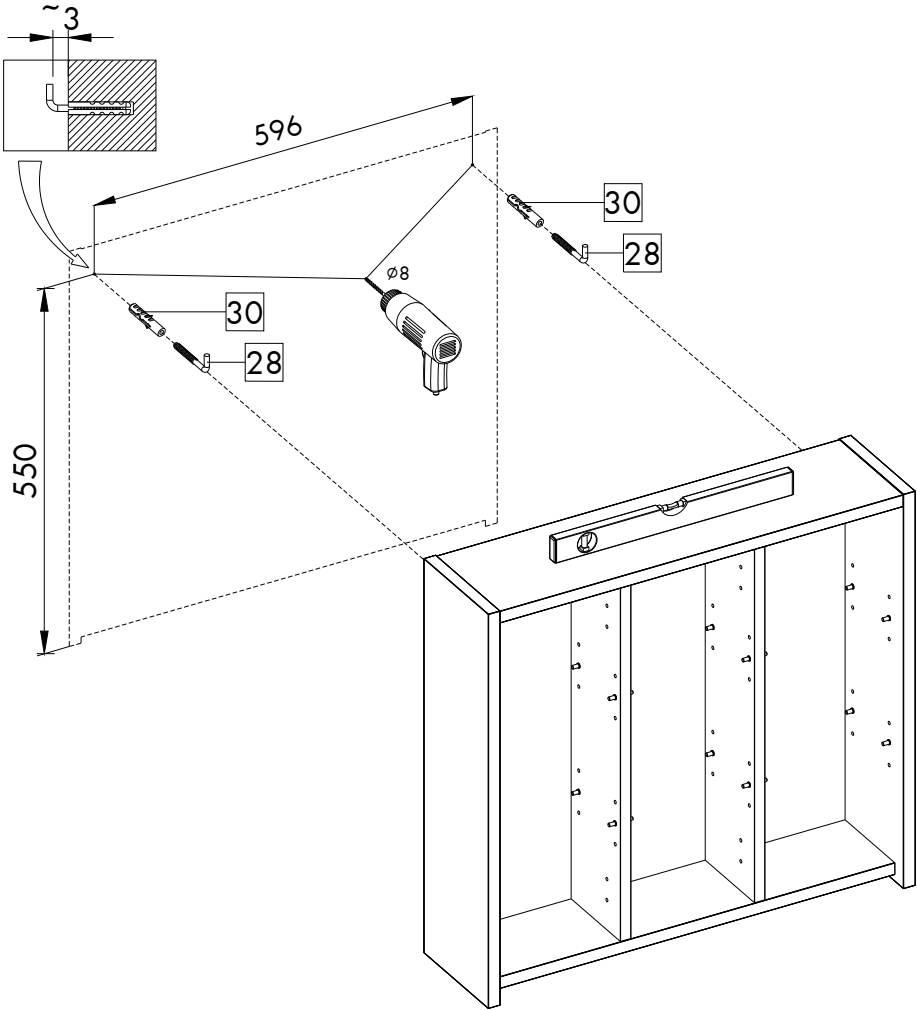
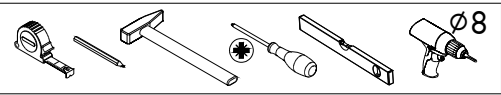
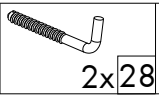
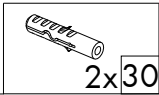

J

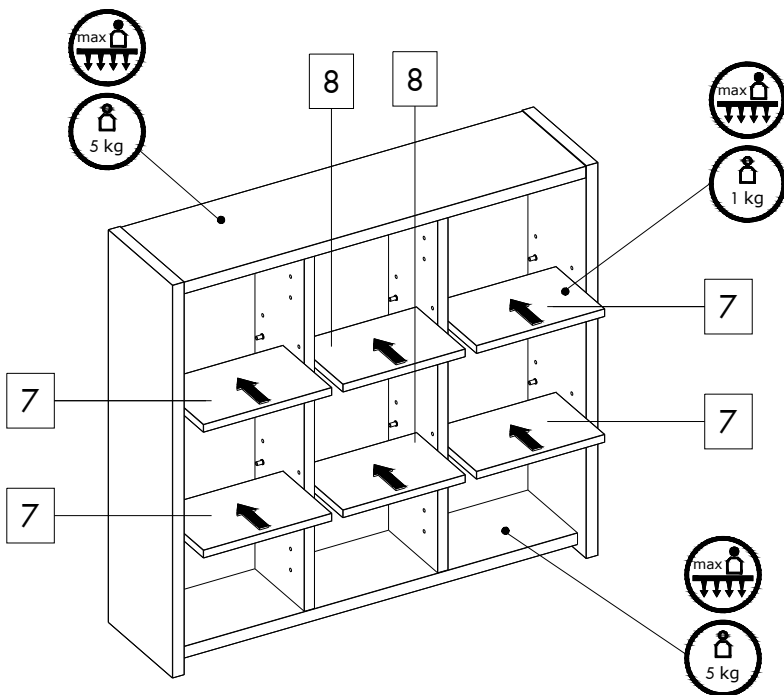

K

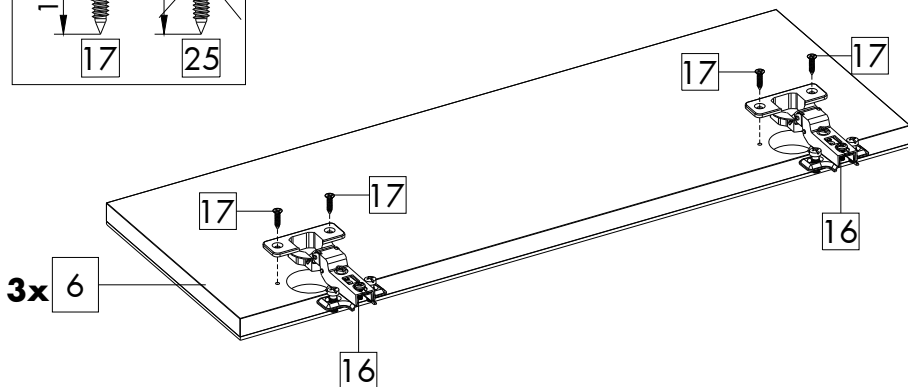
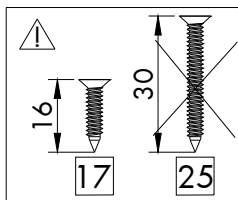
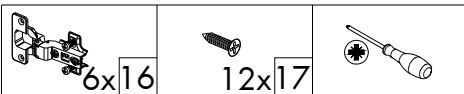

L



x2

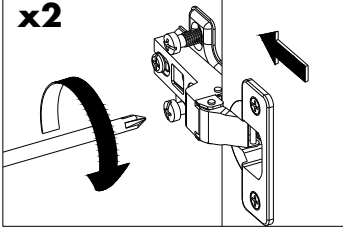

L

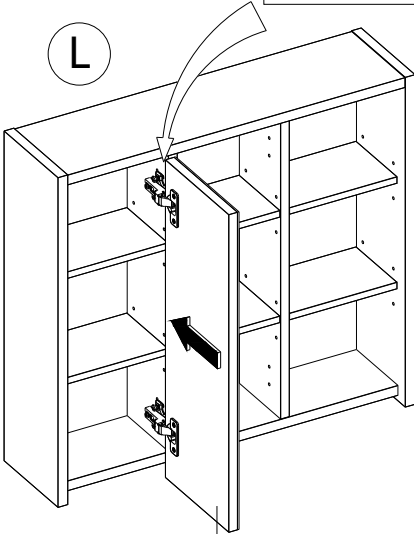

6

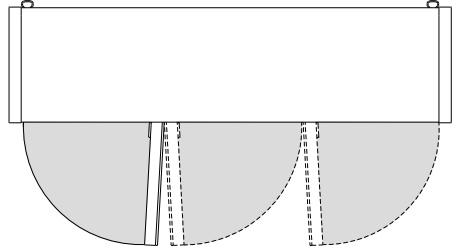

x2

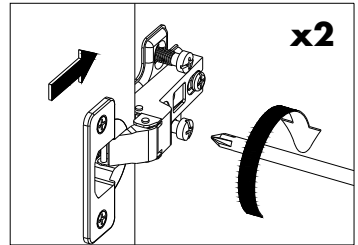

R

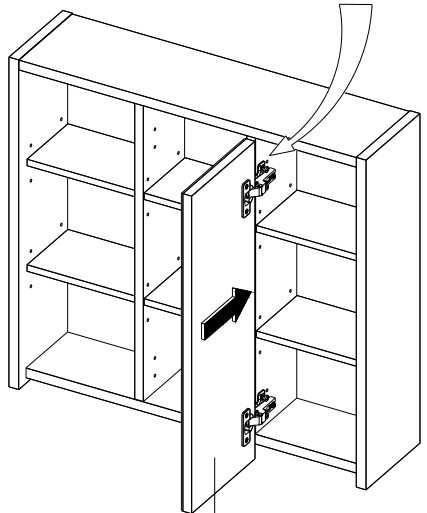
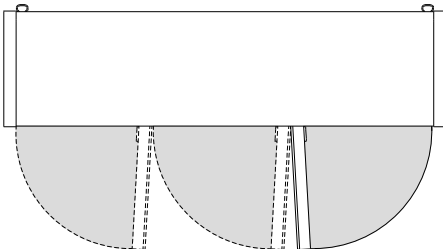

6

M



L

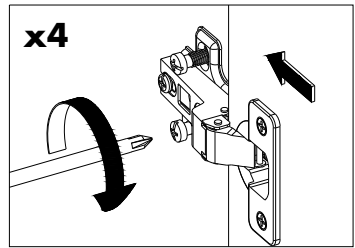
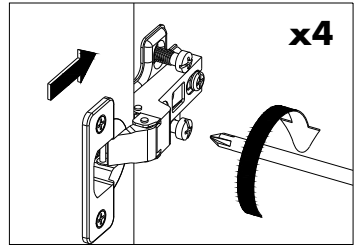
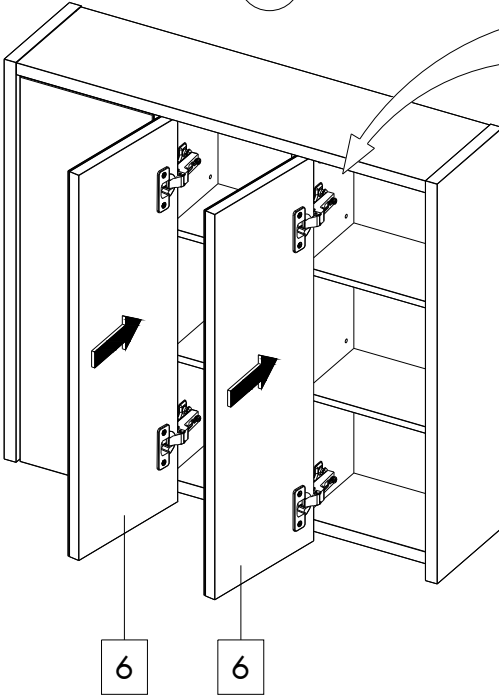

R

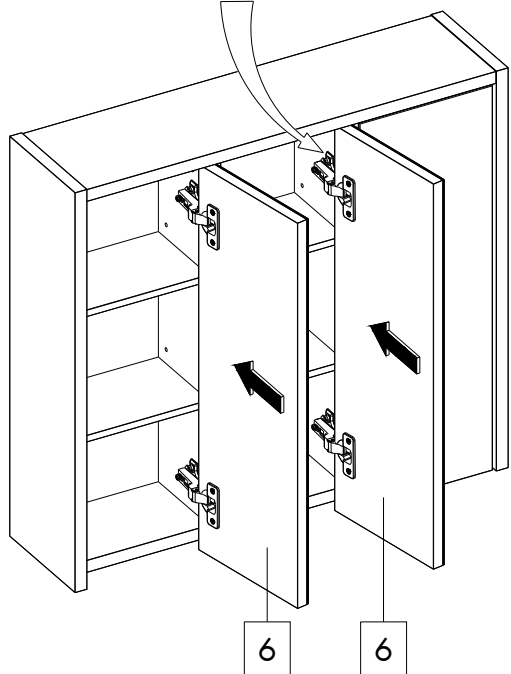

N

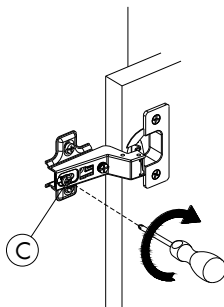
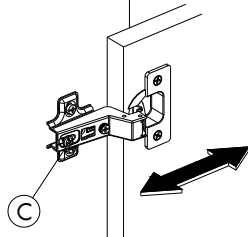
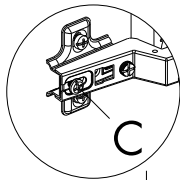
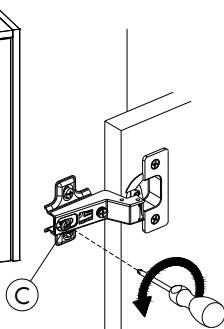
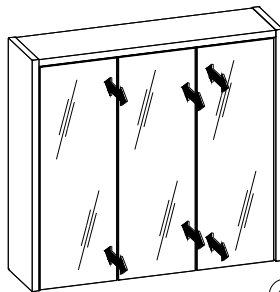
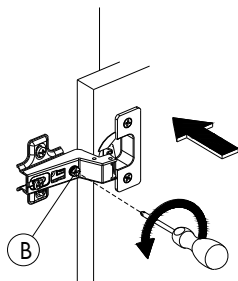
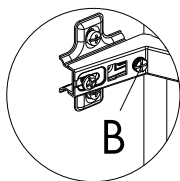
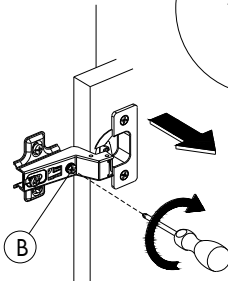
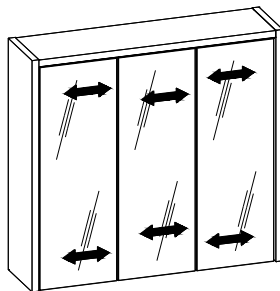
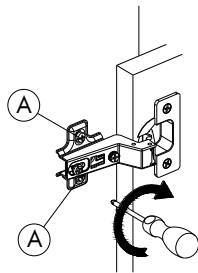
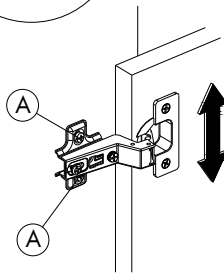
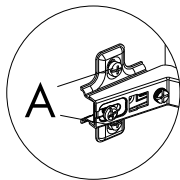
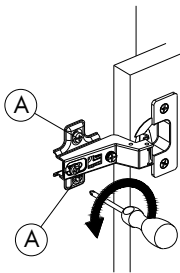
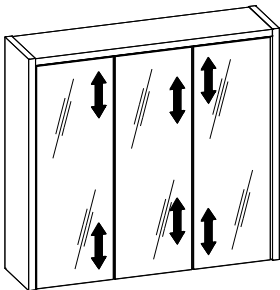
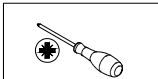

MEBLOMASTER sp. j.
Zelce I 3a
07-100 Wegrów
POLAND

reklamacje@meblomaster.pl
+48 (25) 740 26 21

MR1401
10 / 2025

IAN 508157_2507

