

POLIZEISTATION/ FEUERWEHRSTATION/ LIDL-FILIALE/ TIERKLINIK

DE AT CH

POLIZEISTATION/ FEUERWEHRSTATION/ LIDL-FILIALE/ TIERKLINIK

Gebrauchsanweisung

FR CH

POSTE DE POLICE/ CASERNE DE POMPIERS/ SUPERMARCHÉ LIDL/ CLINIQUE VÉTÉRINAIRE

Notice d'utilisation

IT CH

CENTRALE DI POLIZIA/ CASERMA DEI POMPIERI/ FILIALE LIDL/ CLINICA VETERINARIA

Istruzioni d'uso



IAN 460693_2401

DE AT CH
FR IT



PDF ONLINE
www.lidl-service.com

DELTA-SPORT HANDELSKONTOR GMBH
Wragekamp 6 • 22397 Hamburg
GERMANY

05/2024

Delta-Sport-Nr.: CL-12810, CL-12811, CL-12813, CL-14759

IAN 460693_2401



CL-12810

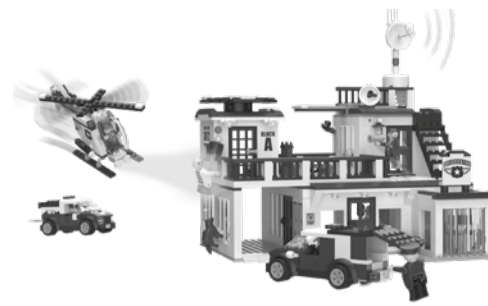

CL-12811

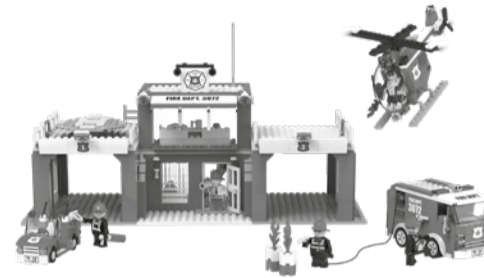

CL-12813



CL-14759



Herzlichen Glückwunsch!

Mit Ihrem Kauf haben Sie sich für einen hochwertigen Artikel entschieden. Machen Sie sich vor der ersten Verwendung mit dem Artikel vertraut.

Lesen Sie hierzu aufmerksam die nachfolgende Gebrauchsanweisung.

Benutzen Sie den Artikel nur wie beschrieben und für die angegebenen Einsatzbereiche. Bewahren Sie diese Gebrauchsanweisung gut auf. Händigen Sie alle Unterlagen bei Weitergabe des Artikels an Dritte ebenfalls mit aus.

Lieferumfang

CL-12810

848 x Einzelteil
1 x Stickerbogen
1 x Aufbauanleitung
1 x Gebrauchsanweisung

CL-12811

834 x Einzelteil
1 x Stickerbogen
1 x Aufbauanleitung
1 x Gebrauchsanweisung

CL-12813

929 x Einzelteil
1 x Stickerbogen
1 x Aufbauanleitung
1 x Gebrauchsanweisung

CL-14759

865 x Einzelteil
1 x Stickerbogen
1 x Aufbauanleitung
1 x Gebrauchsanweisung

Technische Daten

Herstellungsdatum (Monat/Jahr): 05/2024

Hiermit erklärt Delta-Sport Handelskontor GmbH, dass dieser Artikel mit den folgenden grundlegenden Anforderungen und den übrigen einschlägigen Bestimmungen übereinstimmt:

2009/48/EG – Spielzeug-Richtlinie

Bestimmungsgemäße Verwendung

Dieser Artikel ist ein Spielzeug für Kinder ab 5 Jahren für den privaten Gebrauch.

Sicherheitshinweise

- Achtung. Nicht für Kinder unter 36 Monaten geeignet. Erstickungsgefahr. Kleine Teile.
- Kinder dürfen nur unter Aufsicht von Erwachsenen mit dem Artikel spielen.

DE/AT/CH

- Achtung. Alle Verpackungs- und Befestigungsmaterialien sind nicht Bestandteil des Spielzeugs und müssen aus Sicherheitsgründen stets entfernt werden, bevor der Artikel Kindern zum Spielen übergeben wird.
- Prüfen Sie den Artikel vor jedem Gebrauch auf Beschädigungen oder Abnutzungen. Der Artikel darf nur in einwandfreiem Zustand verwendet werden!

Lagerung, Reinigung

Lagern Sie den Artikel bei Nichtbenutzung immer trocken und sauber bei Raumtemperatur. Nur mit einem trockenen Reinigungstuch sauber wischen.

WICHTIG! Nie mit scharfen Reinigungsmitteln reinigen.

Hinweise zur Entsorgung

Entsorgen Sie den Artikel und die Verpackungsmaterialien entsprechend den aktuellen örtlichen Vorschriften. Bewahren Sie Verpackungsmaterialien (wie z. B. Folienbeutel) für Kinder unerreichbar auf.

Weitere Informationen zur Entsorgung des ausgedienten Artikels erhalten Sie bei Ihrer Gemeinde- oder Stadtverwaltung. Entsorgen Sie den Artikel und die Verpackung umweltschonend.



Der Recycling-Code dient der Kennzeichnung verschiedener Materialien zur Rückführung in den Wiederverwertungskreislauf (Recycling). Der Code besteht aus einem Recyclingsymbol für den Verwertungskreislauf und einer Nummer, die das Material kennzeichnet.

Hinweise zur Garantie und Serviceabwicklung

Der Artikel wurde mit großer Sorgfalt und unter ständiger Kontrolle produziert. DELTA-SPORT HANDELSKONTOR GmbH räumt privaten Endkunden auf diesen Artikel drei Jahre Garantie ab Kaufdatum (Garantiefrist) nach Maßgabe der folgenden Bestimmungen ein. Die Garantie gilt nur für Material- und Verarbeitungsfehler. Die Garantie erstreckt sich nicht auf Teile, die der normalen Abnutzung unterliegen und deshalb als Verschleißteile anzusehen sind (z. B. Batterien) sowie nicht auf zerbrechliche Teile wie Schalter oder Teile, die aus Glas gefertigt sind.

Ansprüche aus dieser Garantie sind ausgeschlossen, wenn der Artikel unsachgemäß oder missbräuchlich oder nicht im Rahmen der vorgesehenen Bestimmung oder des vorgesehenen Nutzungsumfangs verwendet wurde oder Vorgaben in der Anleitung/Anweisung nicht beachtet wurden, es sei denn, der Endkunde weist nach, dass ein Material- oder Verarbeitungsfehler vorliegt, der nicht auf einem der vorgenannten Umstände beruht.

Ansprüche aus der Garantie können nur innerhalb der Garantiefrist unter Vorlage des Originalkassenbelegs geltend gemacht werden. Bitte bewahren Sie deshalb den Originalkassenbeleg auf. Die Garantiefrist wird durch etwaige Reparaturen aufgrund der Garantie, gesetzlicher Gewährleistung oder Kulanz nicht verlängert. Dies gilt auch für ersetzte und reparierte Teile.

Bitte wenden Sie sich bei Beanstandungen zunächst an die untenstehende Service-Hotline oder setzen Sie sich per E-Mail mit uns in Verbindung. Liegt ein Garantiefall vor, wird der Artikel von uns – nach unserer Wahl – für Sie kostenlos repariert, ersetzt oder der Kaufpreis erstattet. Weitere Rechte aus der Garantie bestehen nicht.

Ihre gesetzlichen Rechte, insbesondere Gewährleistungsansprüche gegenüber dem jeweiligen Verkäufer, werden durch diese Garantie nicht eingeschränkt.

IAN: 460693_2401

DE Kundenservice Deutschland
Tel.: 0800 5435 111
E-Mail: deltasport@lidl.de

AT Service Österreich
Tel.: 0800 447744
E-Mail: deltasport@lidl.at

CH Service Schweiz
Tel.: 0800 56 44 33
E-Mail: deltasport@lidl.ch

DE/AT/CH

DE/AT/CH

Félicitations !

Vous venez d’acquérir un article de grande qualité. Avant la première utilisation, familiarisez-vous avec l’article.

📖 **Pour cela, veuillez lire attentivement la notice d’utilisation suivante.**

Utilisez l’article uniquement comme indiqué et pour les domaines d’utilisation mentionnés. Conservez bien cette notice d’utilisation. Si vous cédez l’article à un tiers, veillez à lui remettre l’ensemble de la documentation.

Contenu de la livraison

CL-12810

- 848 pièces
- 1 feuille d’autocollants
- 1 notice de montage
- 1 notice d’utilisation

CL-12811

834 pièces

- 1 feuille d’autocollants
- 1 notice de montage
- 1 notice d’utilisation

CL-12813

929 pièces

- 1 feuille d’autocollants
- 1 notice de montage
- 1 notice d’utilisation

CL-14759

865 pièces

- 1 feuille d’autocollants
- 1 notice de montage
- 1 notice d’utilisation

Données techniques

📅 Date de fabrication (mois/année) : 05/2024

CE Delta-Sport Handelskontor GmbH déclare par la présente que cet article répond aux exigences essentielles et aux autres dispositions en vigueur suivantes :

2009/48/CE – Directive relative à la sécurité des jouets

Utilisation conforme

Cet article est un jouet pour enfants à partir de 5 ans destiné à un usage privé.

⚠ Instructions de sécurité

- Attention. Ne convient pas aux enfants de moins de 36 mois. Danger d’étouffement. Petites balles.
- Les enfants ne doivent jouer avec l’article que sous la surveillance d’adultes.
- Attention. Les matériaux d’emballage et de fixation ne font pas partie du jouet et doivent toujours être enlevés pour des raisons de sécurité avant que le produit ne soit remis aux enfants pour jouer.
- Avant la première utilisation, veuillez vérifier que l’article ne présente aucun dommage ni signe d’usure. L’article ne doit être utilisé que dans un parfait état !

Stockage, nettoyage

Lorsque vous n’utilisez pas l’article, rangez-le toujours dans un endroit sec et propre à une température ambiante. Essayez uniquement avec un chiffon de nettoyage à sec. IMPORTANT ! Ne jamais laver avec des produits de nettoyage agressifs.

Mise au rebut

♻ Éliminez le produit et les matériaux d’emballage conformément aux réglementations locales actuelles en vigueur. Conservez les matériaux d’emballage (comme les sachets en plastique) hors de portée des enfants. Vous obtiendrez plus d’informations relatives à l’élimination du produit usagé auprès de votre commune ou de votre municipalité. Éliminez le produit et l’emballage dans le respect de l’environnement.

♻ Le code de recyclage est utilisé pour identifier les différents matériaux à retourner dans le cycle de recyclage. Ce code se compose du symbole de recyclage, représentant le cycle de recyclage ainsi que d’un numéro identifiant le matériau.

Indications concernant la garantie et le service après-vente

L’article a été produit avec grand soin et sous un contrôle constant. DELTA-SPORT HANDELSKONTOR GmbH accorde au client final privé une garantie de trois ans sur cet article à compter de la date d’achat (période de garantie) conformément aux dispositions suivantes. La garantie ne vaut que pour les défauts de matériaux et de fabrication. La garantie ne couvre pas les pièces soumises à une usure normale, lesquelles doivent donc être considérées comme des pièces d’usure (comme p. ex., les piles), de même qu’elle ne couvre pas les pièces fragiles, telles que les interrupteurs ou les pièces fabriquées en verre.

FR/CH

FR/CH

FR/CH

Congratulazioni!

Avete acquistato un articolo di alta qualità. Consigliamo di familiarizzare con l’articolo prima di cominciare ad utilizzarlo.

📖 **Leggere attentamente le seguenti istruzioni d’uso.**

Utilizzare l’articolo solo nel modo descritto e per gli ambiti di applicazione indicati. Conservare accuratamente queste istruzioni d’uso. In caso di trasferimento dell’articolo a terzi, consegnare tutti i documenti insieme all’articolo.

Contenuto della confezione

CL-12810

- 848 x singolo pezzo
- 1 x foglio adesivi
- 1 x istruzioni di montaggio
- 1 x istruzioni d’uso

CL-12811

- 834 x singolo pezzo
- 1 x foglio adesivi
- 1 x istruzioni di montaggio
- 1 x istruzioni d’uso

CL-12813

- 929 x singolo pezzo
- 1 x foglio adesivi
- 1 x istruzioni di montaggio
- 1 x istruzioni d’uso

CL-14759

- 865 x singolo pezzo
- 1 x foglio adesivi
- 1 x istruzioni di montaggio
- 1 x istruzioni d’uso

Dati tecnici

📅 Data di produzione (anno/mese) : 05/2024

CE Con la presente Delta-Sport Handelskontor GmbH dichiara che questo articolo è conforme ai seguenti requisiti di base e alle altre disposizioni vigenti :

2009/48/CE – Direttiva sulla sicurezza dei giocattoli

Utilizzo conforme

Questo articolo è un giocattolo per l’uso privato per bambini dai 5 anni in su.

⚠ Avvertenze di sicurezza

- Avvertenza. Non adatto a bambini di età inferiore a 36 mesi. Rischio di soffocamento. Piccole palle.
- I bambini possono giocare con l’articolo solo se sorvegliati da persone adulte.
- Avvertenza. Tutti i materiali della confezione e dei fissaggi non sono parte integrante del giocattolo e per motivi di sicurezza devono sempre essere tolti prima di affidare il prodotto ai bambini che ci giocheranno.
- Prima di ciascun utilizzo, verificare che l’articolo non presenti danni o segni di usura. L’articolo può essere utilizzato solo se in perfetto stato!

Conservazione, pulizia

In caso di mancato utilizzo, riporre l’articolo a temperatura ambiente in un luogo asciutto e pulito.

Pulire solo con un panno asciutto.

IMPORTANTE! Non utilizzare mai detergenti aggressivi.

Smaltimento

♻ Smaltire l’articolo e i materiali della confezione nel rispetto delle attuali normative locali. Conservare i materiali della confezione (come ad es. i sacchetti) in modo che non siano raggiungibili per i bambini. Presso la propria amministrazione comunale o cittadina è possibile ottenere ulteriori informazioni sullo smaltimento dell’articolo alla fine del suo periodo di impiego. Smaltire l’articolo e la confezione nel rispetto dell’ambiente.

♻ Il codice di riciclaggio serve per indicare i diversi materiali per il loro ritorno al ciclo di riutilizzo (recycling). Il codice è composto da un simbolo di riciclaggio per il ciclo di riutilizzo e da un numero che contraddistingue il materiale.

Avvertenze sulla garanzia e sulla gestione dei servizi di assistenza

L’articolo è stato prodotto con la massima cura e sotto un continuo controllo. DELTA-SPORT HANDELSKONTOR GmbH concede ai client finali privati, su questo articolo, tre anni di garanzia dalla data di acquisto (termine di garanzia) sulla base delle seguenti disposizioni. La garanzia vale solo per i vizi di materiale e di lavorazione. La garanzia non si estende alle parti soggette ad un normale degradamento e che siano quindi da considerarsi come pezzi soggetti a usura (p. es. le batterie) né ai pezzi fragili come ad es. interruttori oppure pezzi in vetro.

Les réclamations au titre de cette garantie sont exclues si l’article a été utilisé de manière abusive ou inappropriée, hors du cadre de son usage ou du champ d’application prévu ou si les instructions de la notice d’utilisation n’ont pas été respectées, à moins que le client final ne prouve que l’article présentait un défaut de matériau ou de fabrication n’étant pas dû à l’une des conditions mentionnées ci-dessus. Les réclamations au titre de la garantie ne peuvent être adressées pendant la période de garantie qu’en présentant le ticket de caisse original. Veuillez pour cela conserver le ticket de caisse original. Ceci s’applique également aux pièces remplacées et réparées.

Si vous avez des plaintes à formuler, veuillez d’abord contacter le service d’assistance téléphonique ci-dessous ou nous contacter par courrier électronique. Si le cas est couvert par la garantie, nous nous engageons - à notre appréciation - à réparer ou à remplacer l’article gratuitement pour vous ou à vous rembourser le prix d’achat. Aucun autre droit ne découle de la garantie.

Vos droits légaux, en particulier les droits de garantie contre le vendeur concerné, ne sont pas limités par cette garantie.

IAN : 460693_2401

CH Service Suisse
Tel. : 0800 56 44 33
E-Mail : deltasport@lidl.ch

Dalla presente garanzia sono escluse le richieste legate a casi di utilizzo non conforme oppure di abuso dell’articolo, oppure di utilizzo avvenuto non nell’ambito delle condizioni previste oppure del campo di impiego previsto, oppure in caso di non osservanza delle direttive riportate nelle istruzioni d’uso, a meno che il cliente non dimostri che sussista un vizio di materiale o di lavorazione che non sia riconducibile ad una delle circostanze riportate sopra.

Le richieste di garanzia possono essere avanzate solo entro il relativo termine, su presentazione dello scontrino originale di acquisto. Si prega quindi di conservare lo scontrino originale. Il termine di garanzia non sarà prolungato a seguito di eventuali riparazioni effettuate sulla base della garanzia, della garanzia obbligatoria prevista per legge oppure di accondiscendenza.

Ciò vale anche per le parti sostituite oppure riparate.

In caso di contestazione rivolgersi dapprima alla hotline di assistenza sotto indicata oppure mettersi in contatto con noi via e-mail. Laddove sussista un caso coperto dalla garanzia, l’articolo sarà - a nostra discrezione - da noi riparato gratuitamente, sostituito oppure sarà rimborsato il prezzo di acquisto. Non sussistono ulteriori diritti derivanti dalla garanzia.

I vostri diritti giuridici, in particolare i diritti di garanzia obbligatoria prevista dalla legge nei confronti del relativo venditore, non sono limitati dalla presente garanzia.

IAN: 460693_2401

CH Assistenza Svizzera
Tel.: 0800 56 44 33
E-Mail: deltasport@lidl.ch

IT/CH

IT/CH

IT/CH

Play
tive



Engineered by

Play
tive
CLIPPYS



2



9x



7x



1x



1x

1x

1

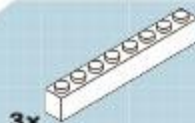

3x

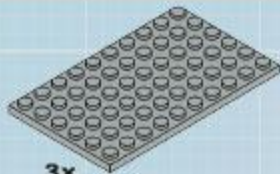

3x



4x



2x



2x

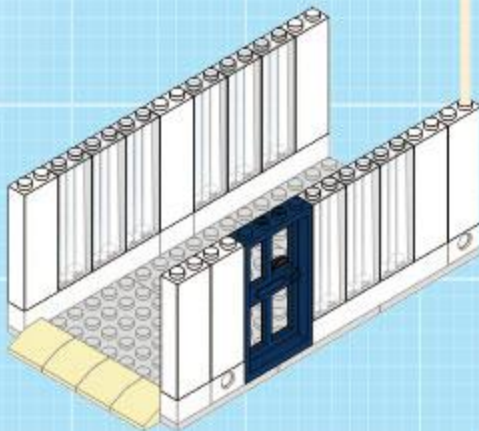
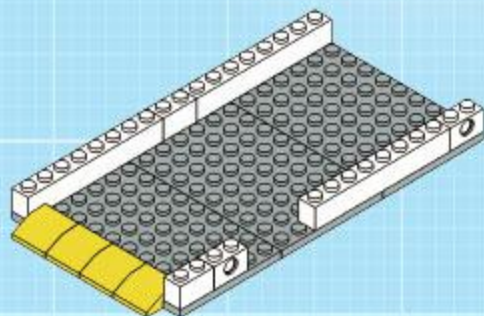

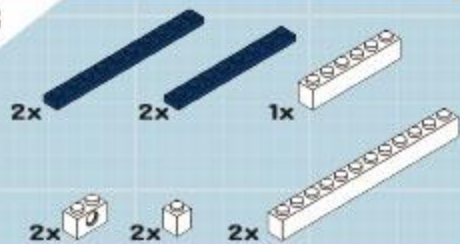
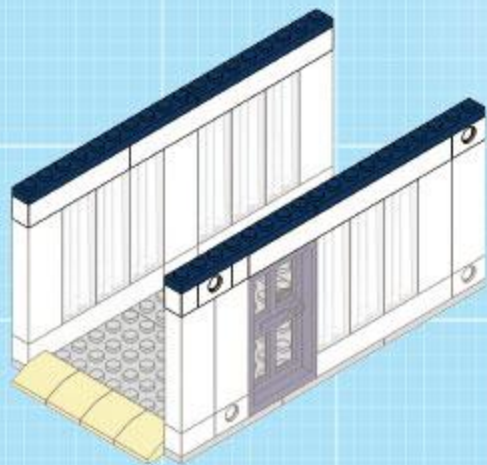
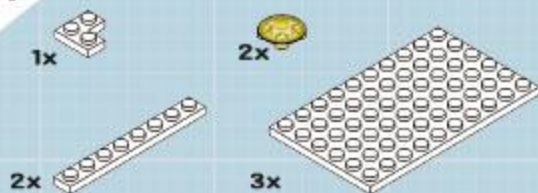
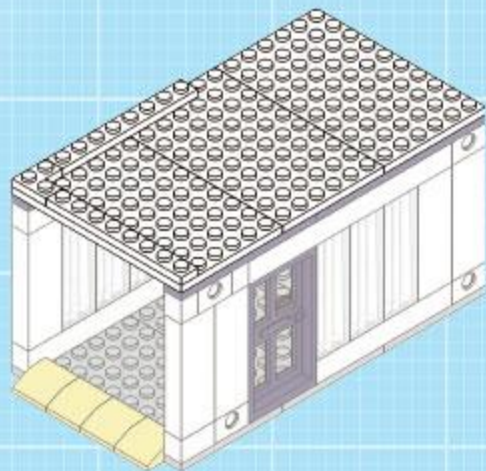
3**4****2**

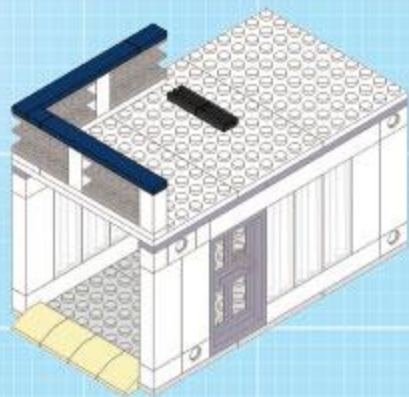
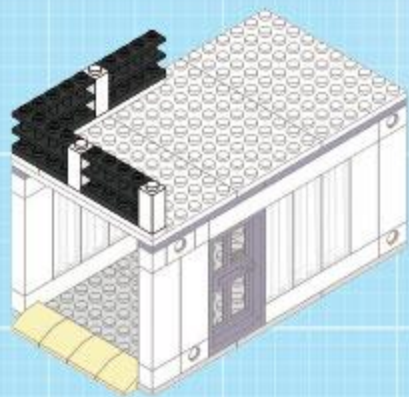
5**6**

7

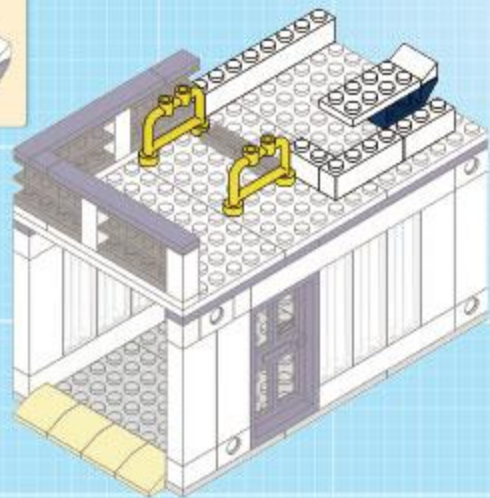
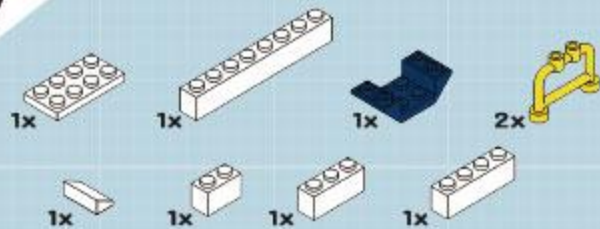

8

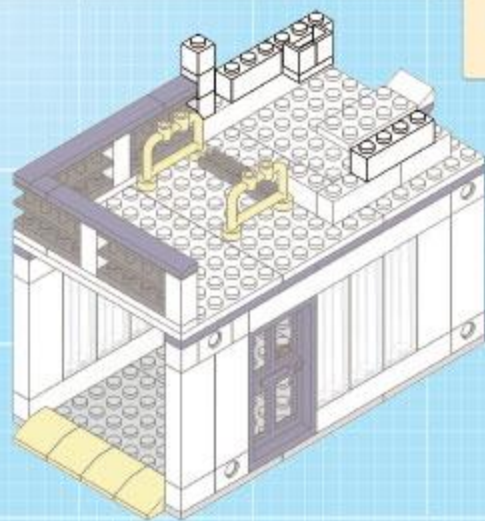
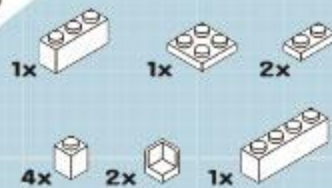

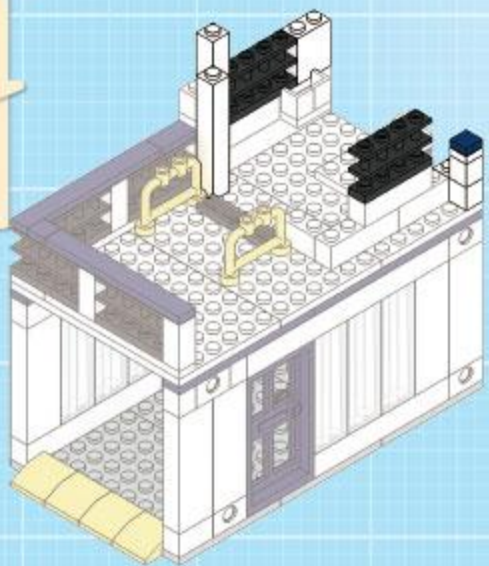
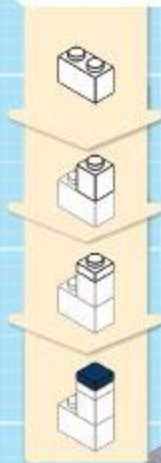
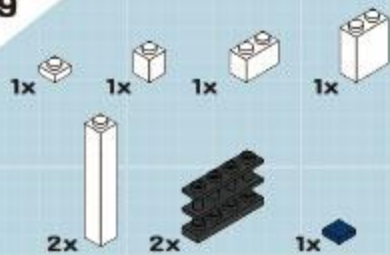
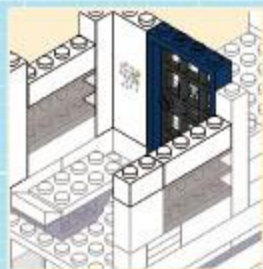
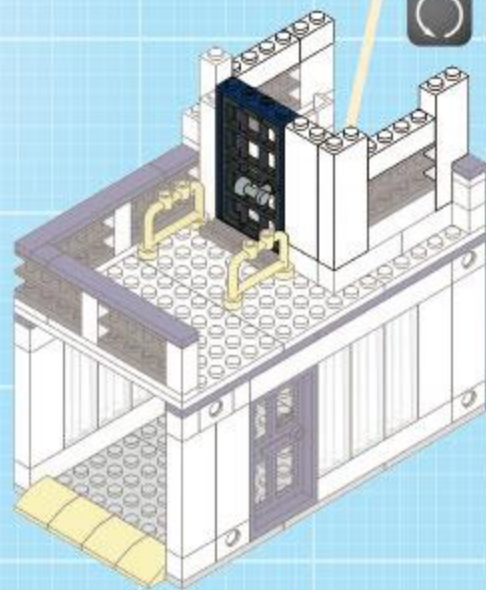
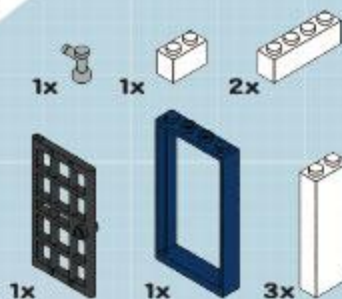
9**10**

11

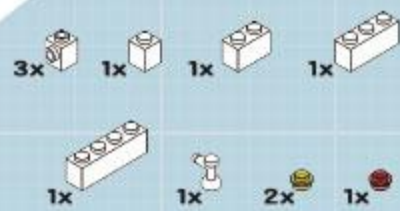

12

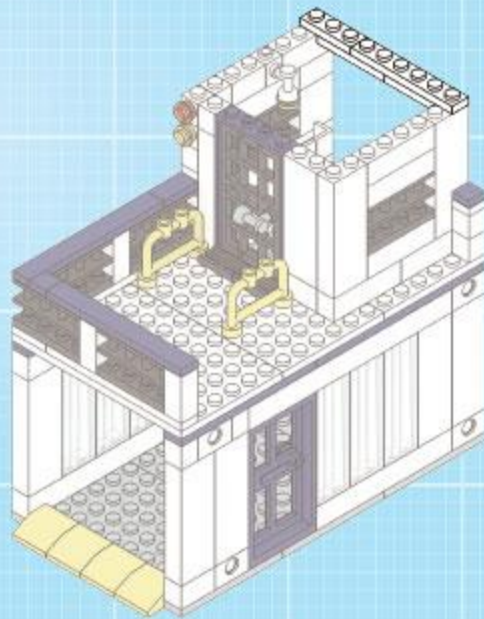

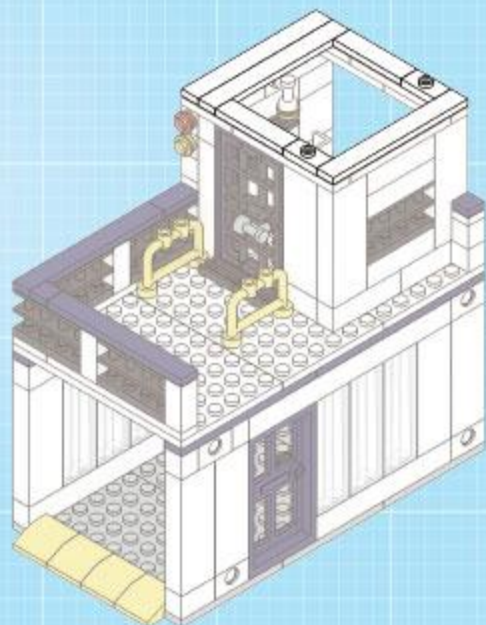
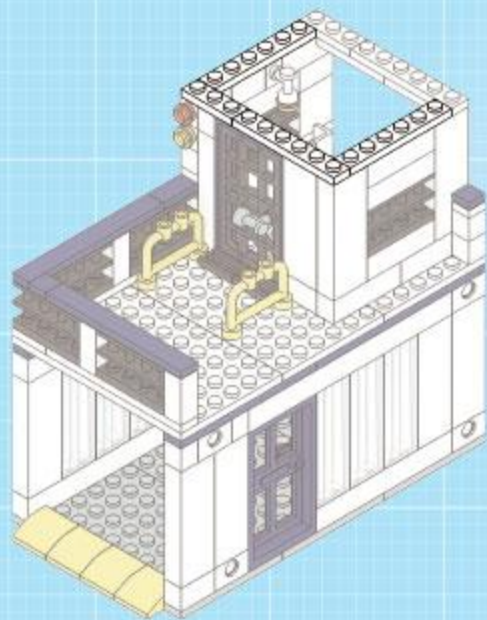
13**14**

15

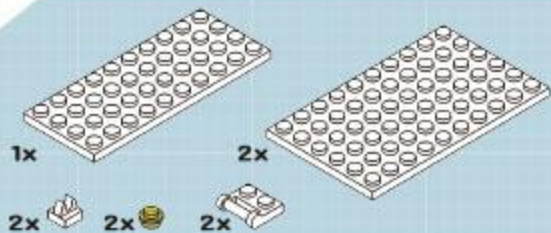

16

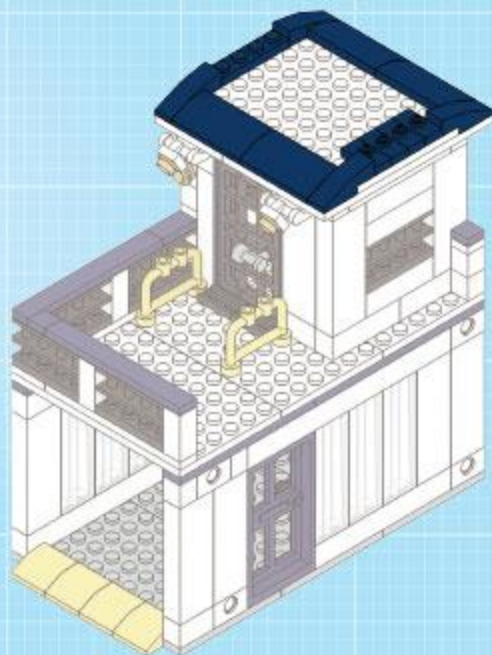
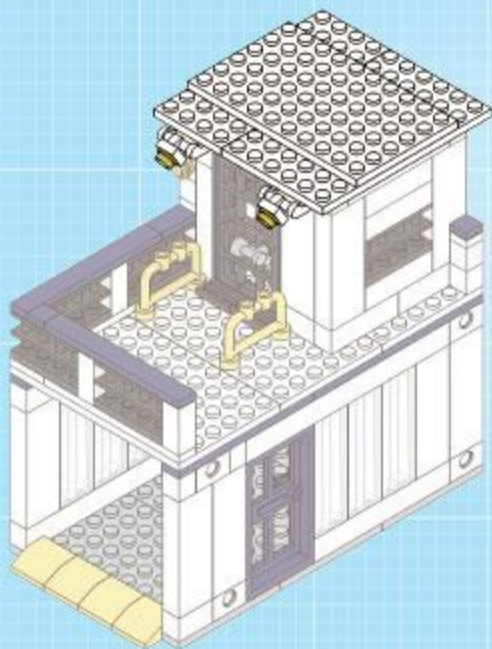
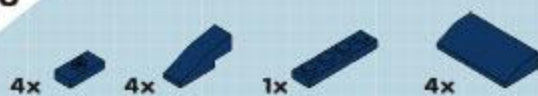

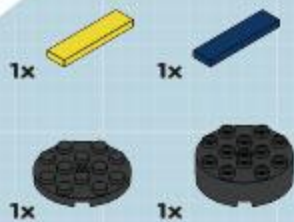
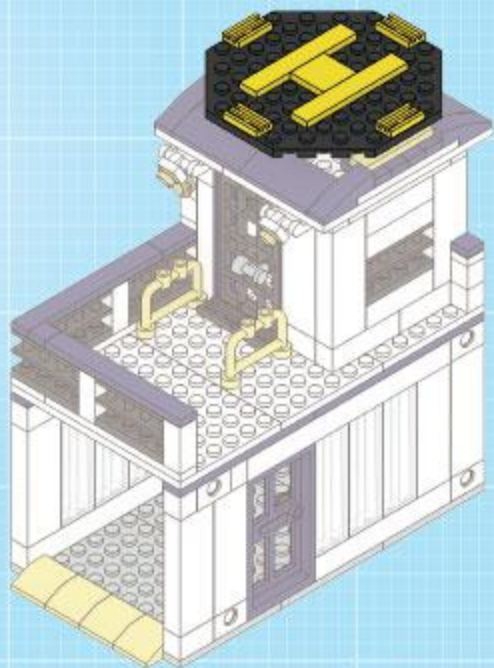
17**18**

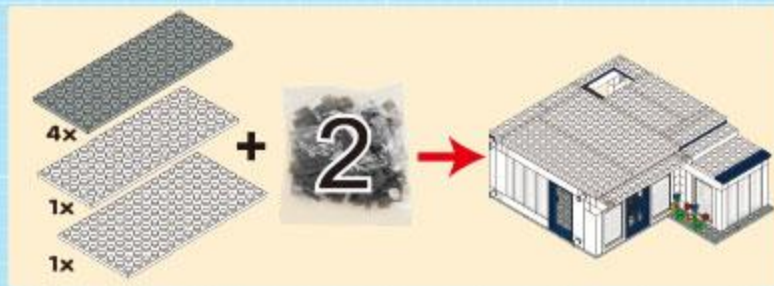
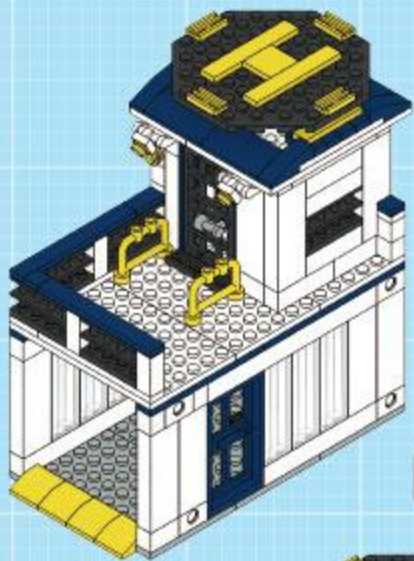

19

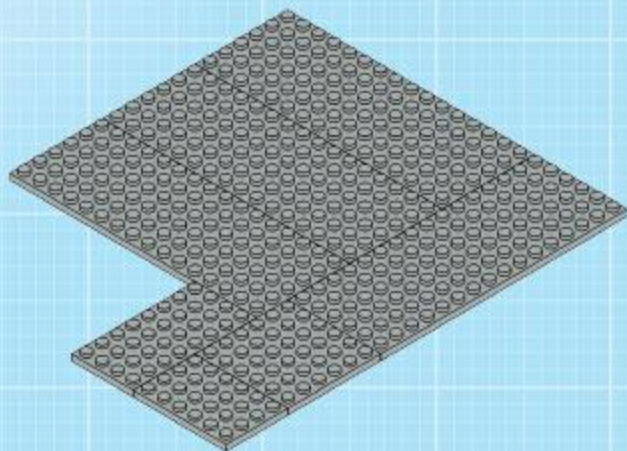
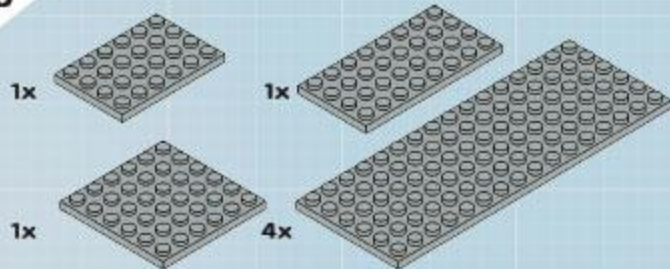

22

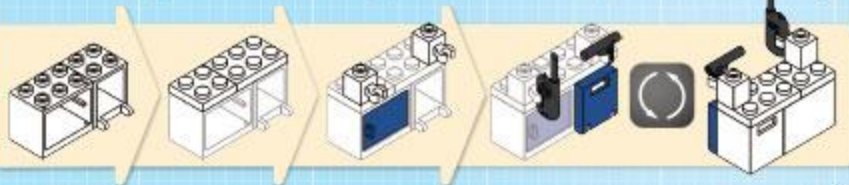
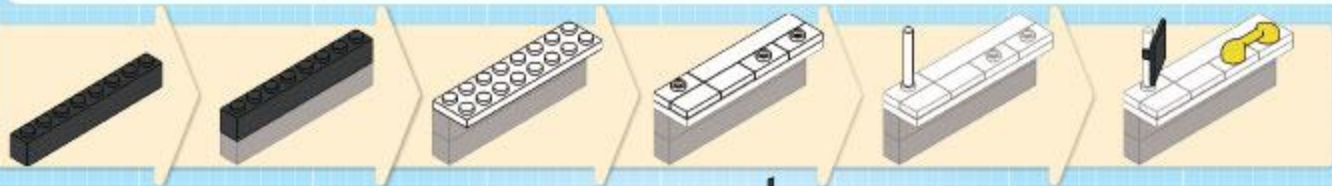
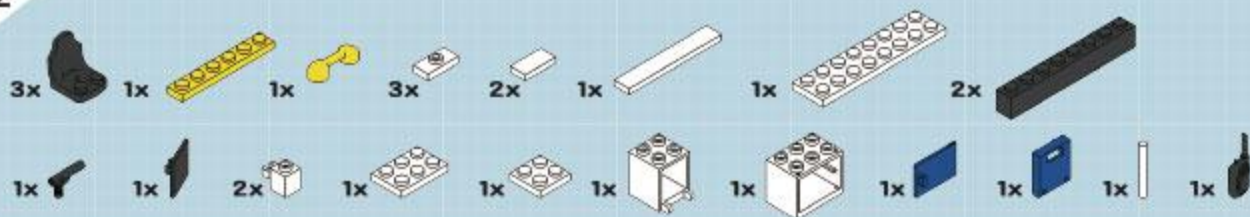

23

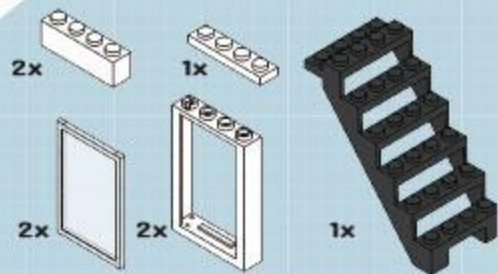

24

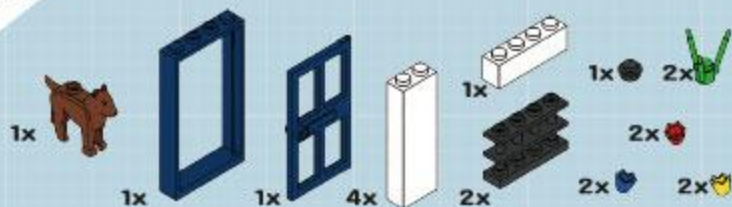

25

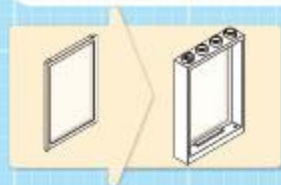
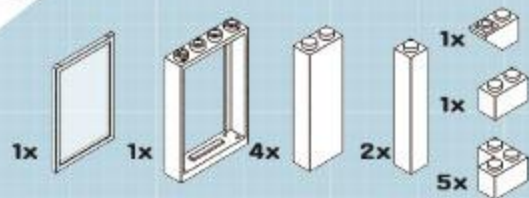

26

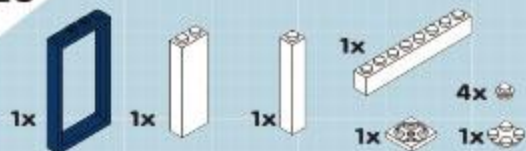

27



28

3x



1x



1x



2x



2x



1x



1x



2x



1x

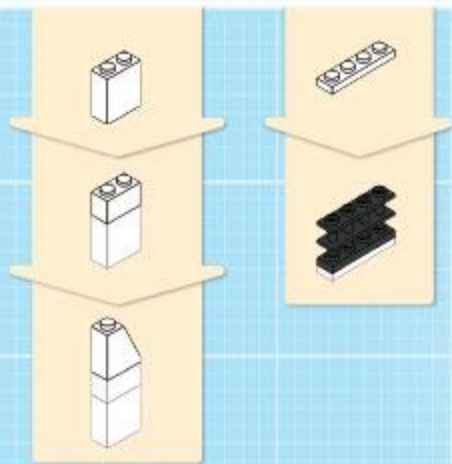

30

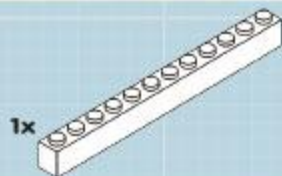
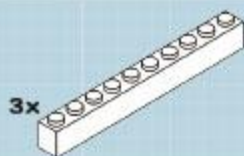
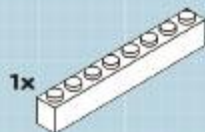
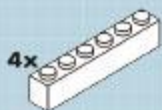
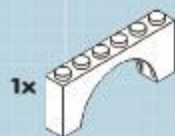

31

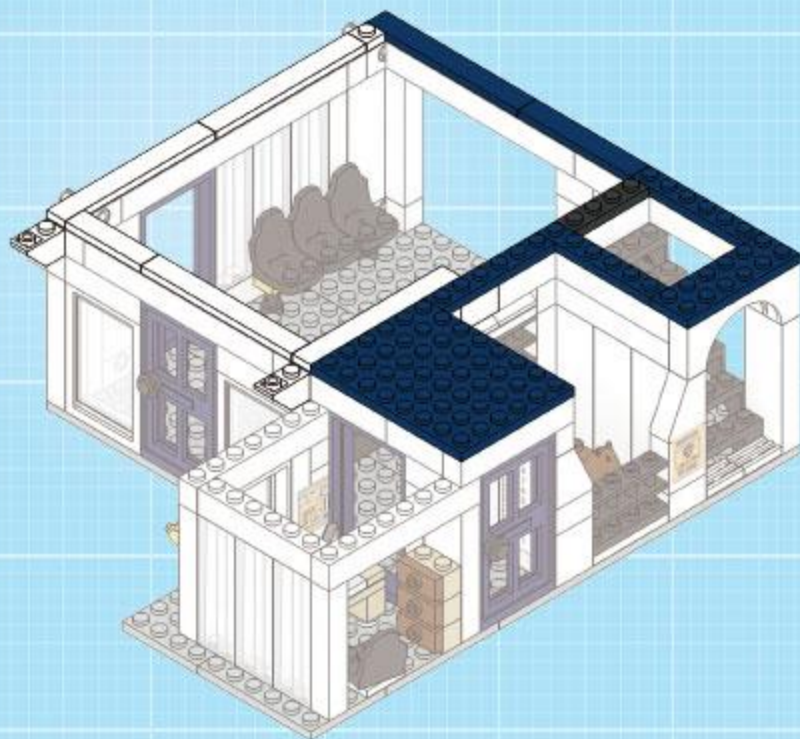
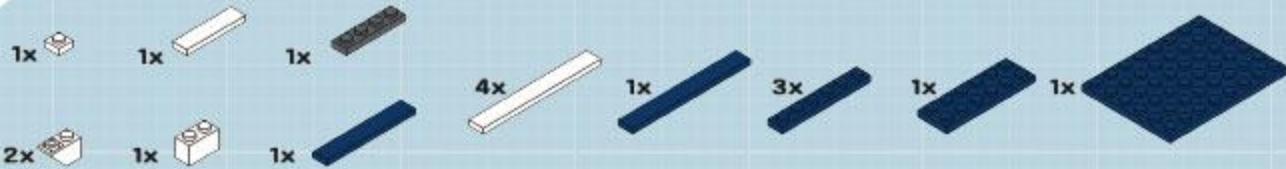

32

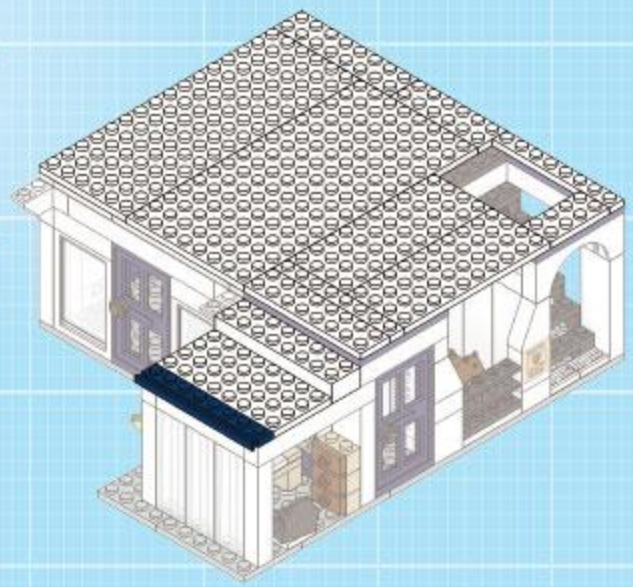
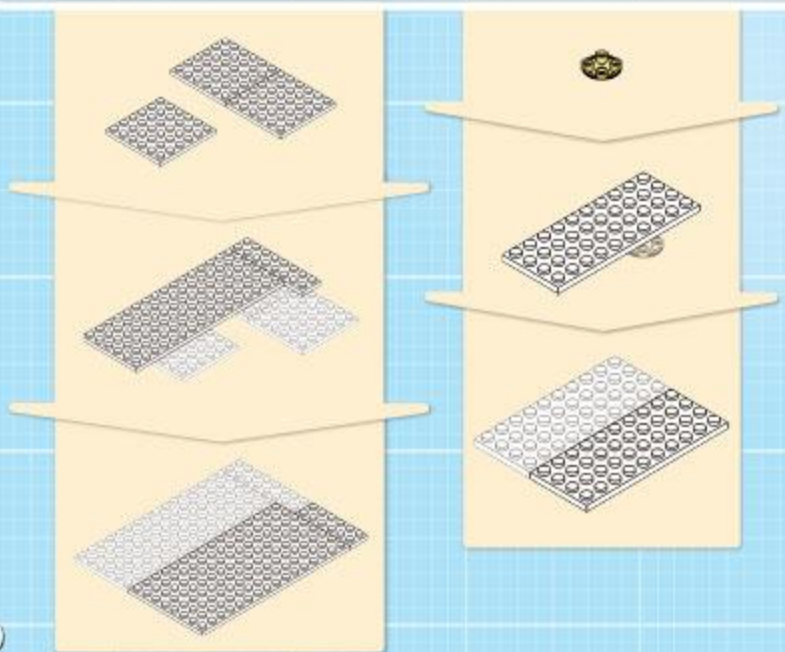
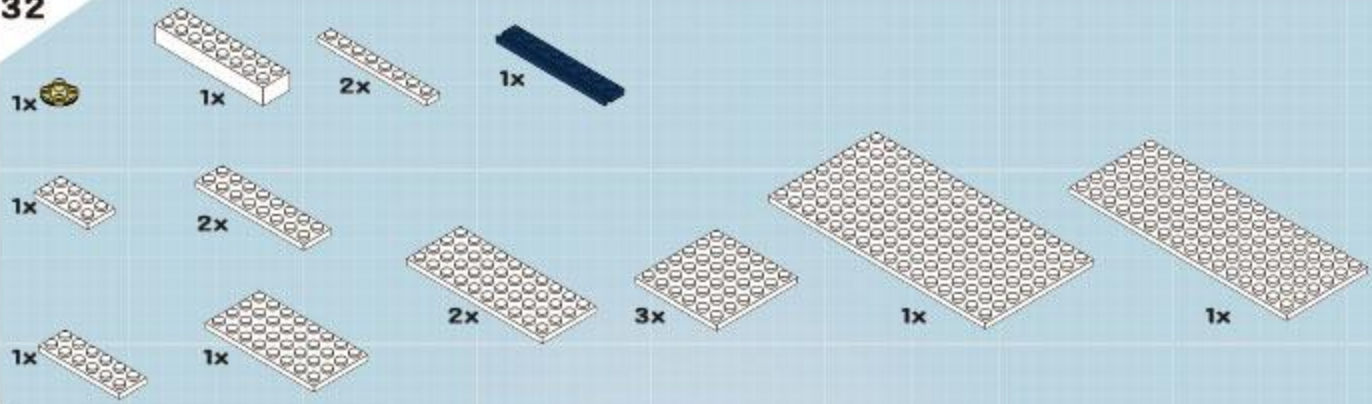

20



33

3x



1x



2x



2x



3x



1x



2x



5x



2x



1x



1x

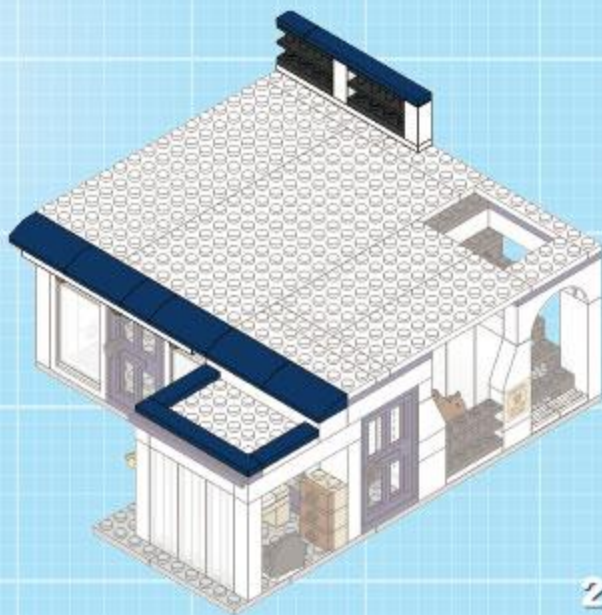
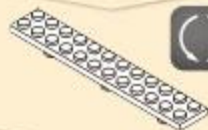
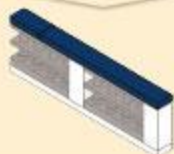

34

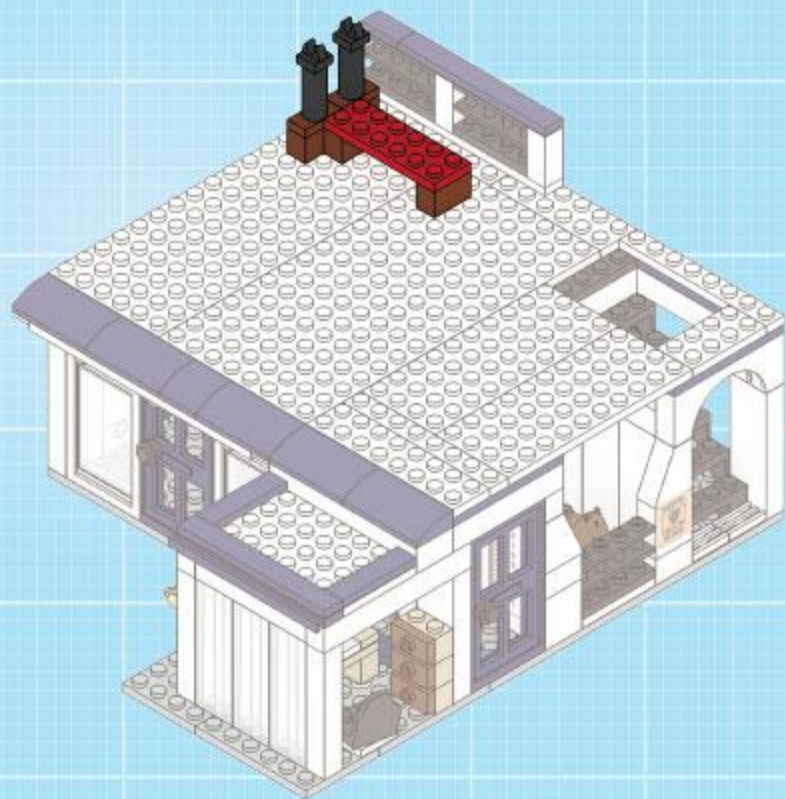
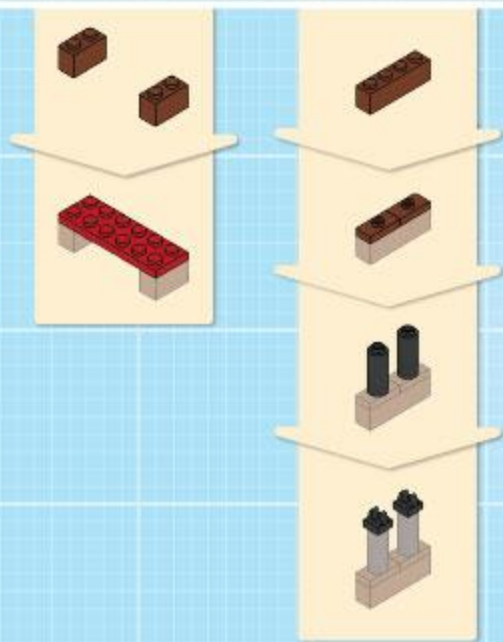
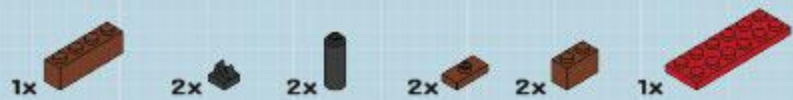

35

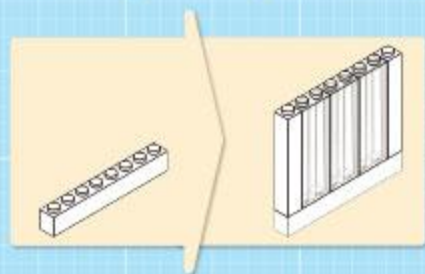
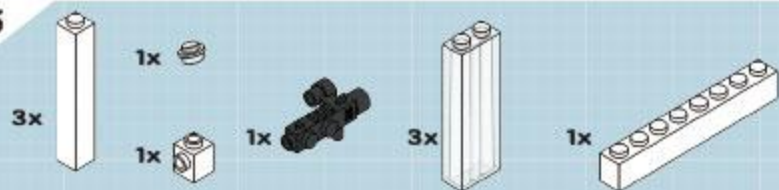

36



37

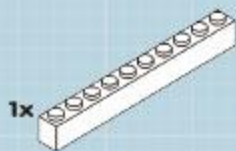

38

2x



1x



1x



1x



4x



2x



1x



2x



1x



1x



2x



3x



3x



1x

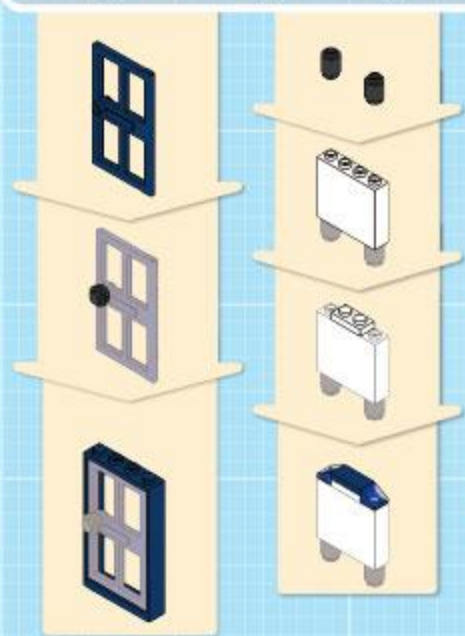

39

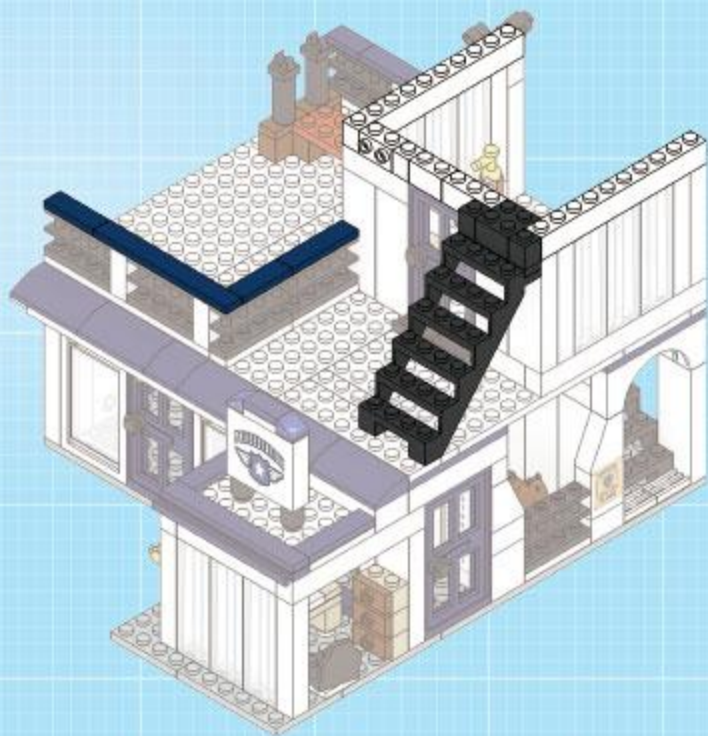
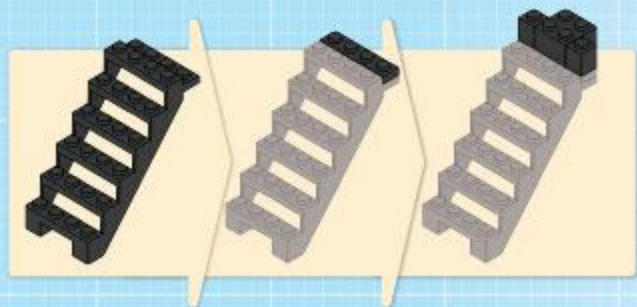

40

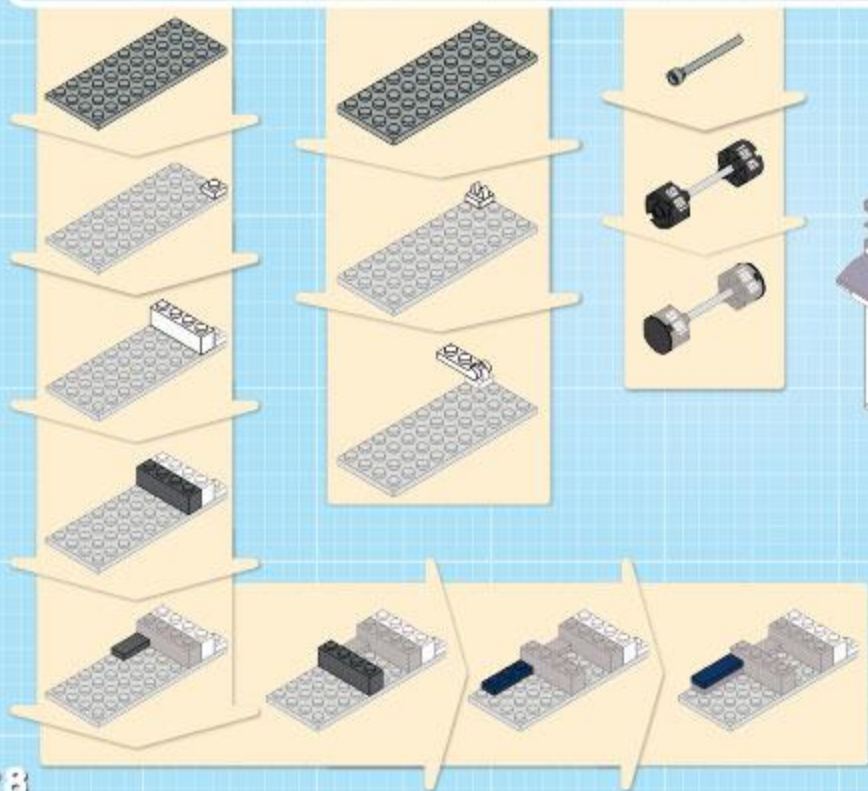
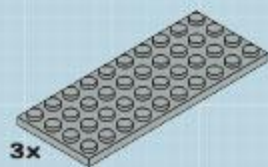

41

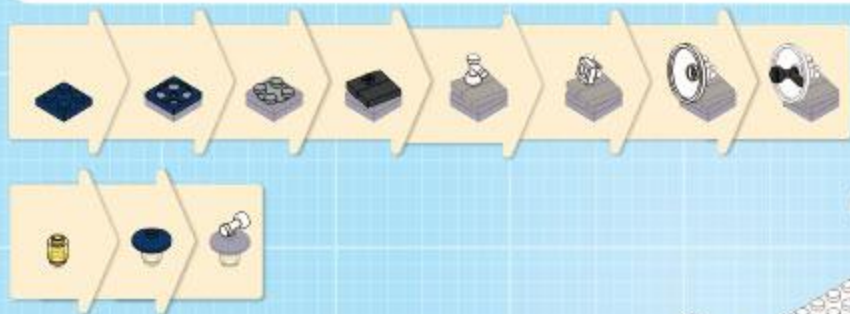

42

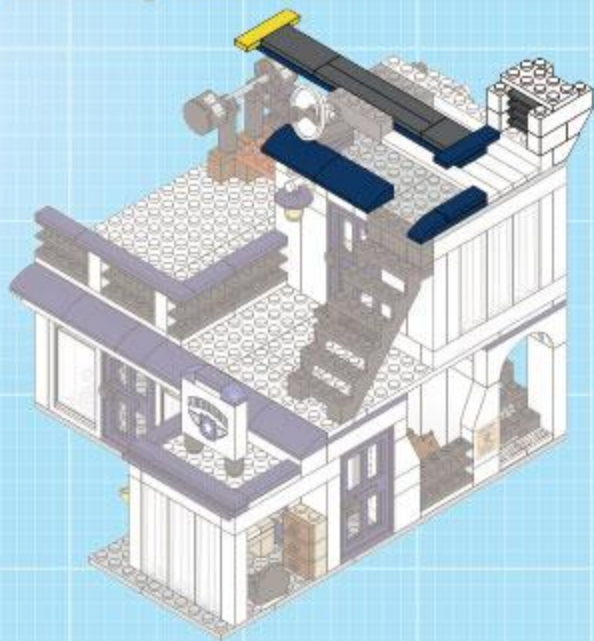
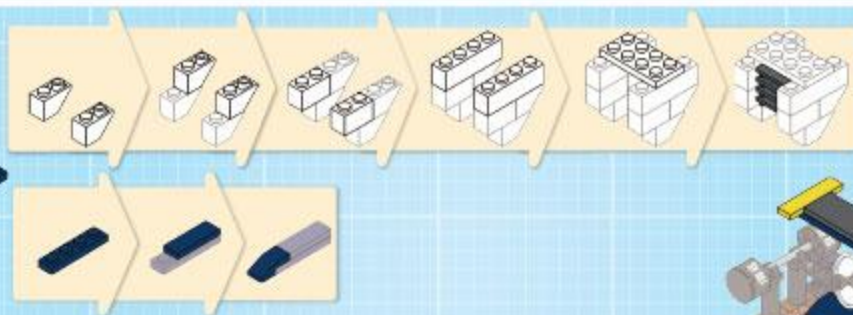
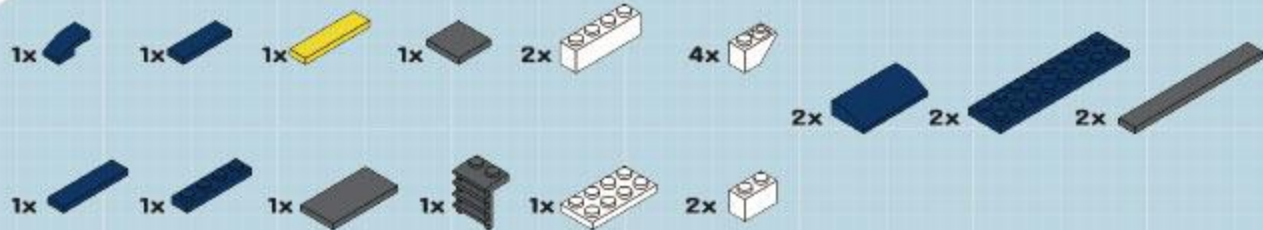

30

43

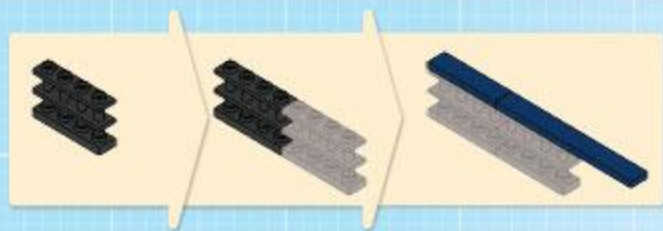
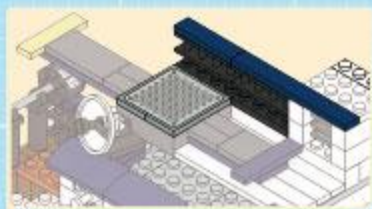

44

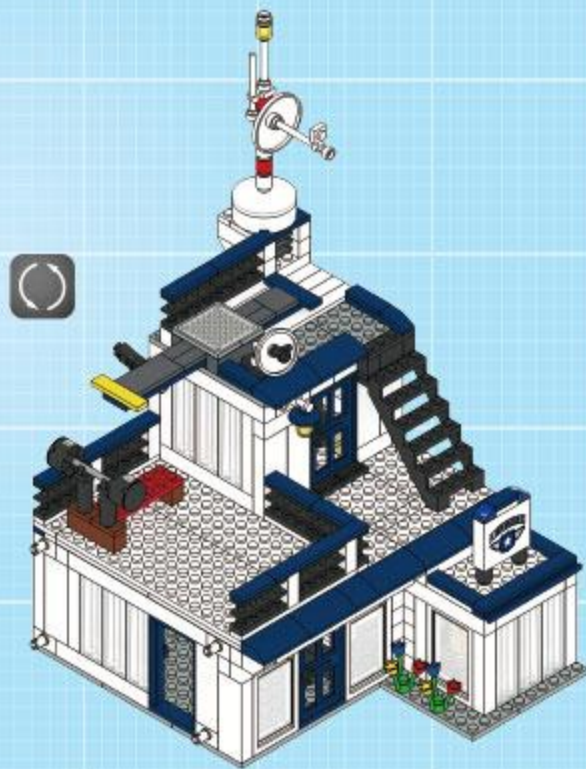

32

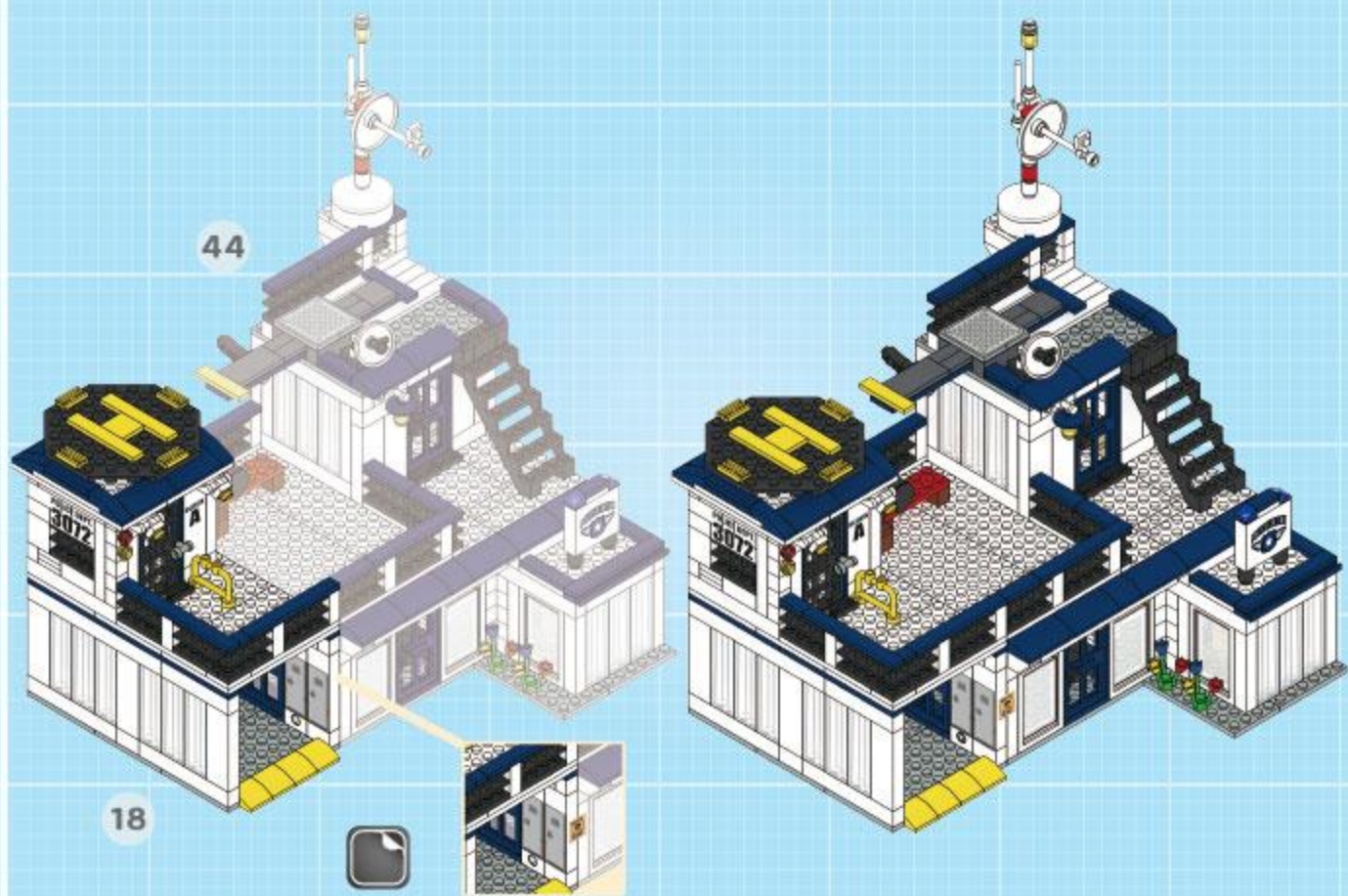

4



46

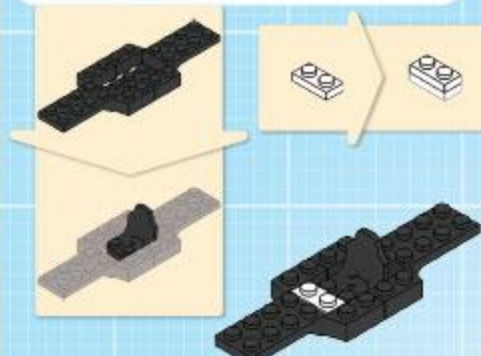

48



47

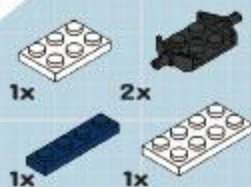

49

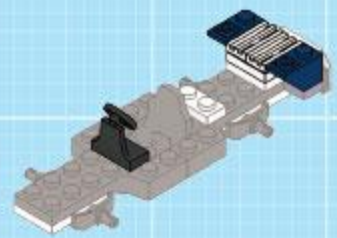
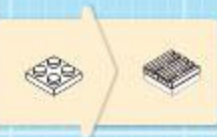
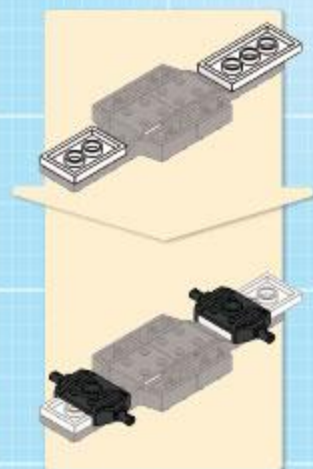

50

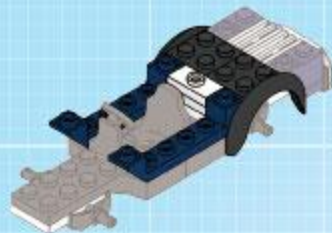
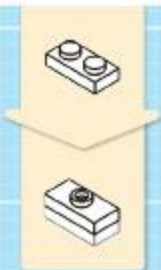

52

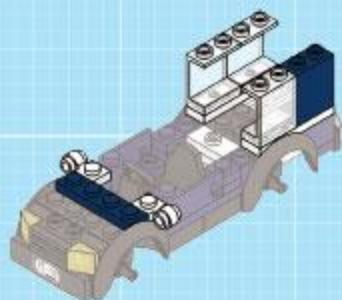

51

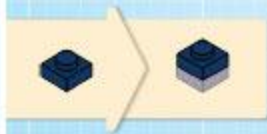

53

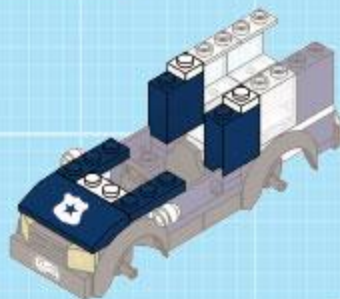
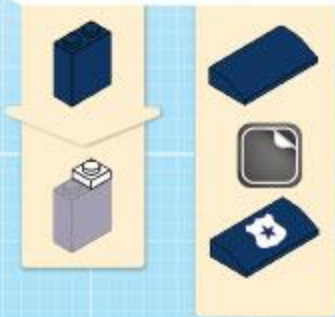

54

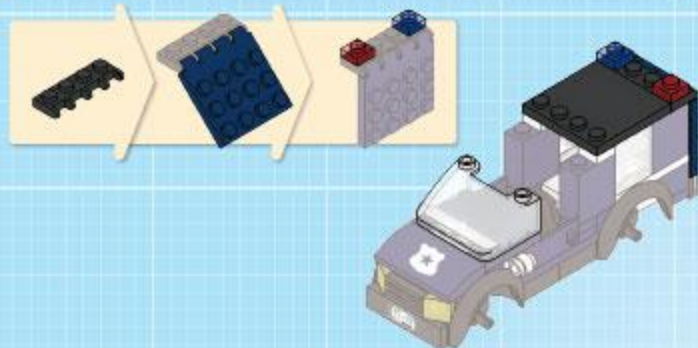

55



5



56

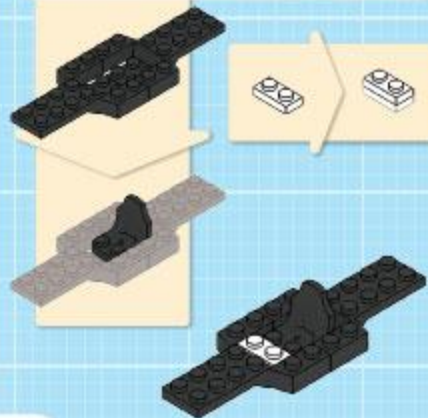

57

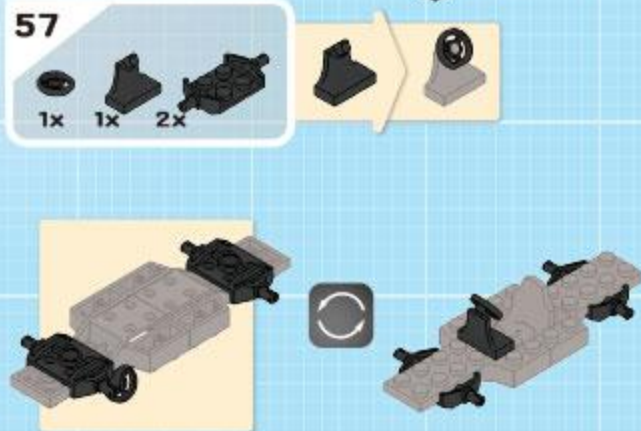

58

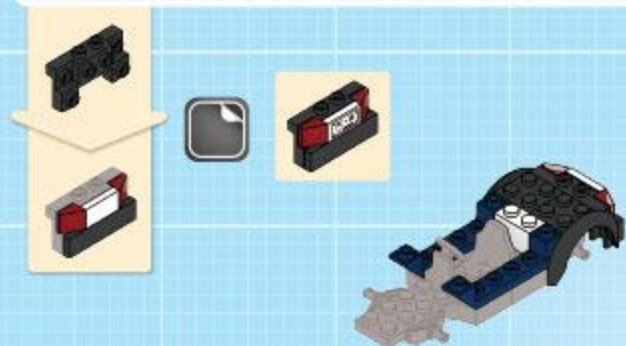

60



59

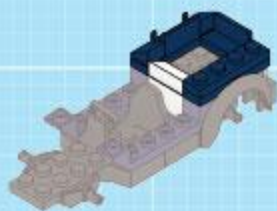
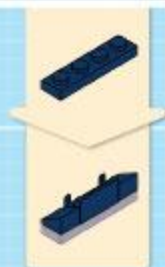
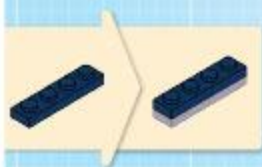
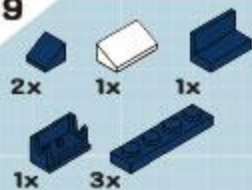

61

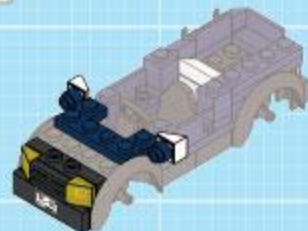

6



66

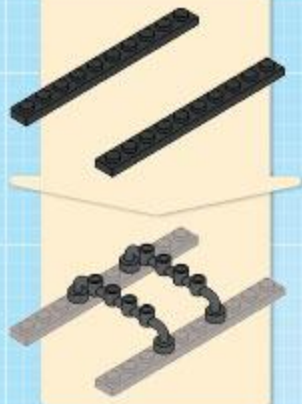

68

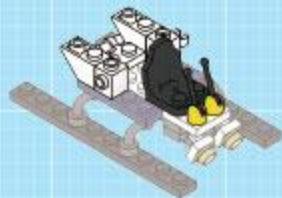

67

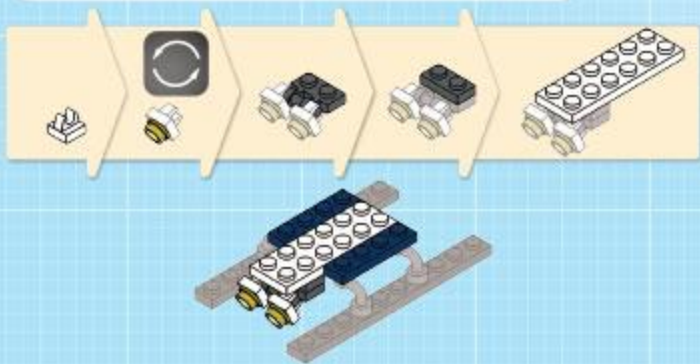

69

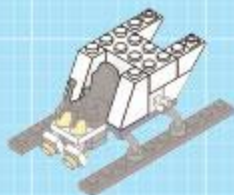
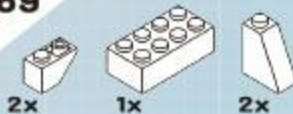

70



72

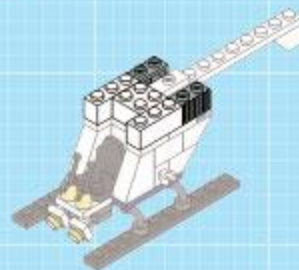

71

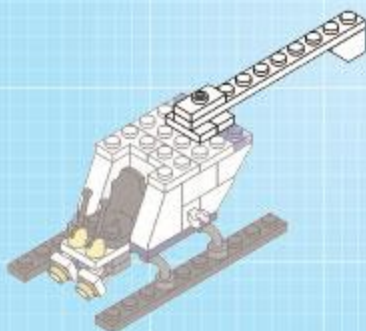

73

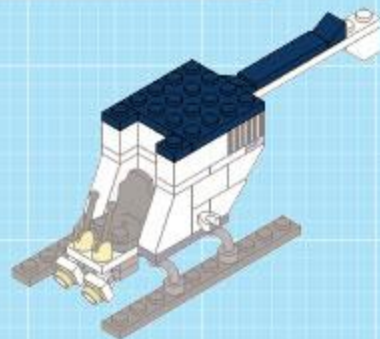

74

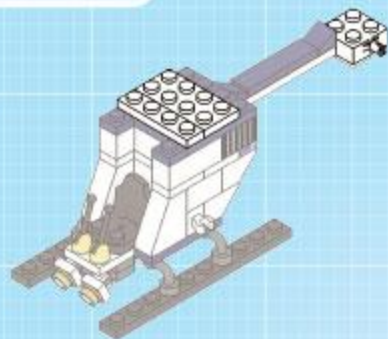

76

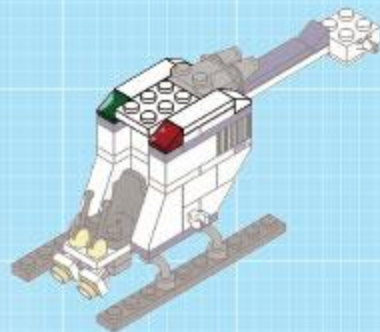

75

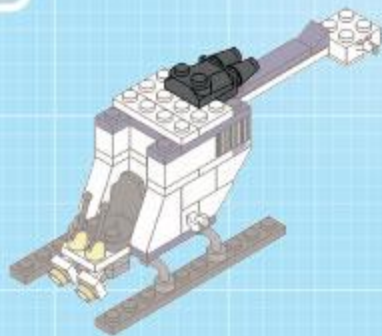

77

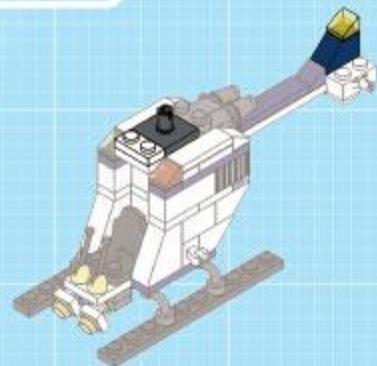

78

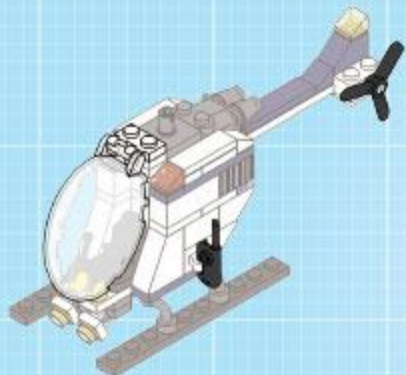

80

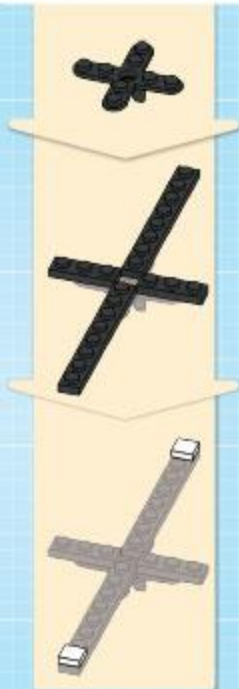

79

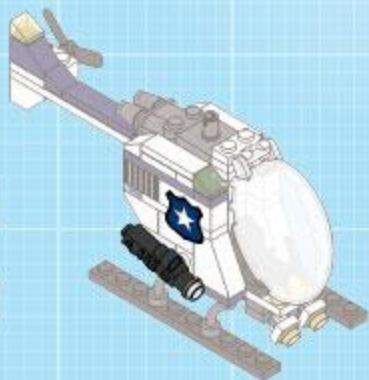

83

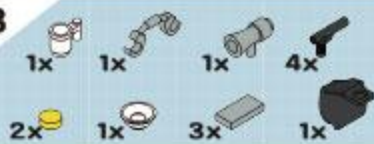

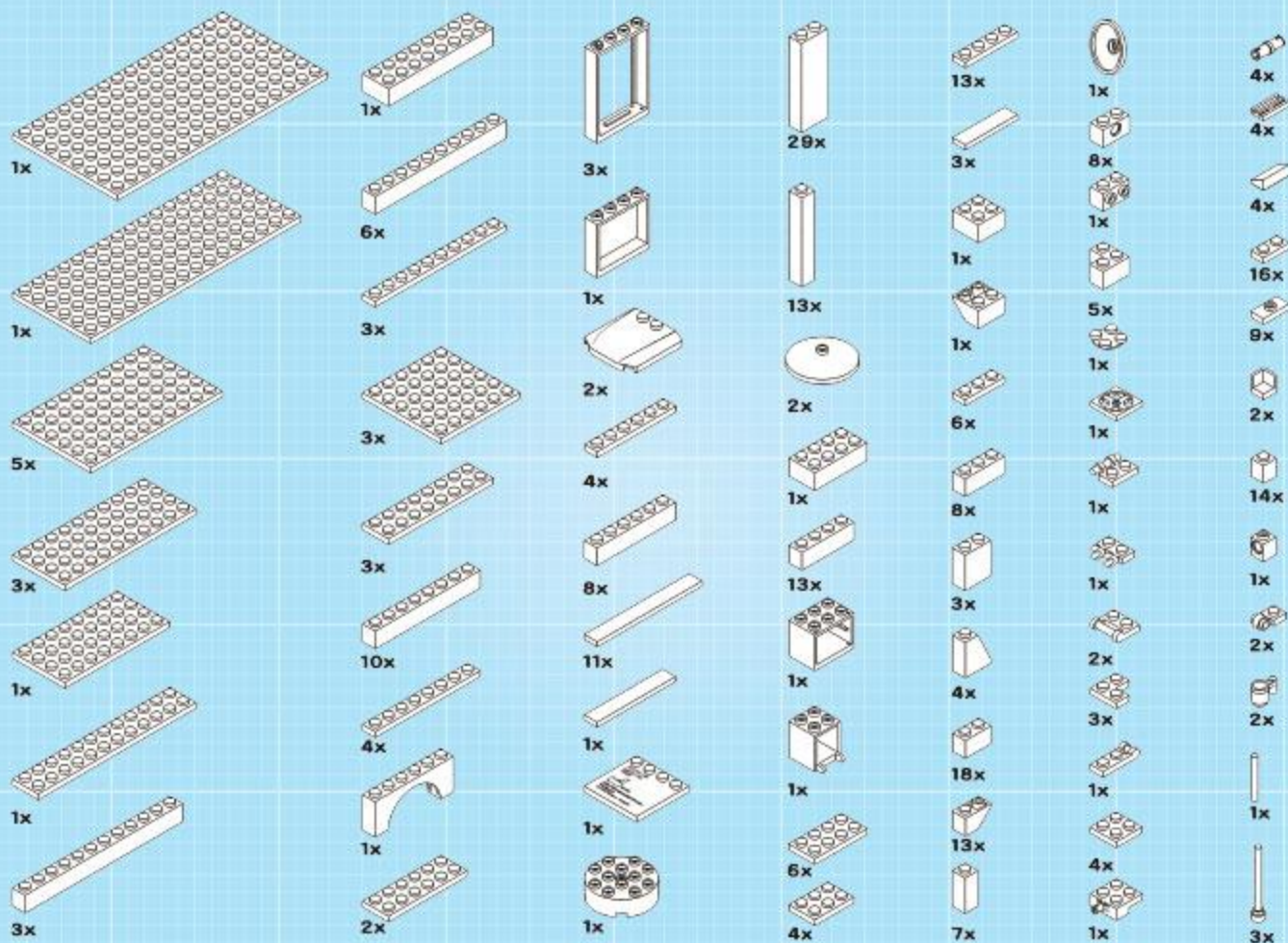



2x



5x



1x



4x



5x



4x



2x



2x



6x



1x



4x



6x



8x



2x

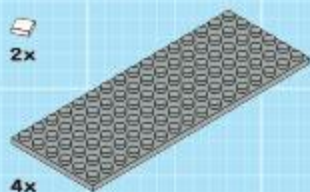

4x



3x



3x



1x

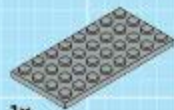

1x



1x



2x



1x



2x



8x



2x



3x



1x



1x



3x



2x



2x



2x



1x



1x



1x



2x



1x



1x



1x



1x



1x



1x



2x



1x



1x



2x



2x

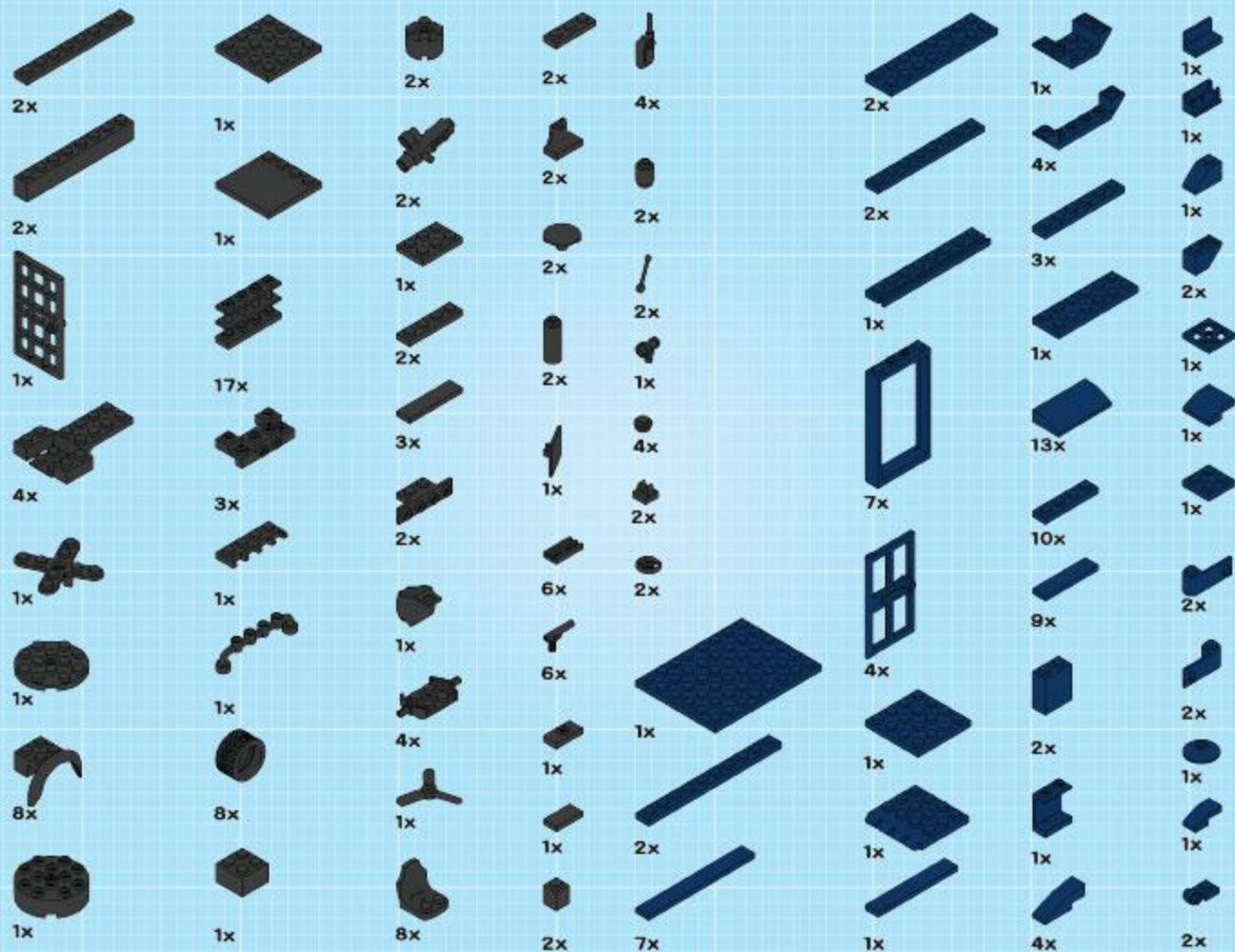

5x

4x

3x

4x

2x

4x

8x

2x

1x

1x

1x

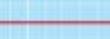
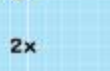

2x

2x

2x

1x

2x

3x

2x

1x

1x

2x

5x

1x

1x

1x



1x

1x

3x

3x

2x

2x

1x

1x

1x

1x

2x

2x

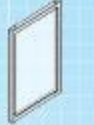

1x

2x

3x

21x

3x

2x

2x

2x

2x

3x



3x

2x

9x

5x

1x

5x

1x

1x

1x

5x

5x

1x



3x

3x

1x

1x

2x

1x

1x

1x

1x

1x

1x

2x



1x

1x

1x

1x

1x

1x

1x

1x

1x

1x

1x

1x