

crelândo®

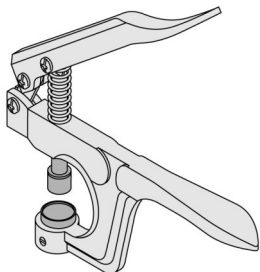

Style No.: 1142



PRESS STUD SET WITH PLIERS

(GB) (IE) (NI)

PRESS STUD SET WITH PLIERS

Assembly instructions

(NL) (BE)

DRUKKERSET MET TANG

Installatie-instructies

(DE) (AT) (CH)

DRUCKKNOPF-SET MIT ZANGE

Montageanleitung

(FR) (BE)

SET DE BOUTONS- PRESSION AVEC PINCE

Instructions d'installation















































































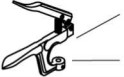
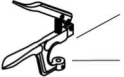









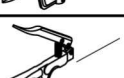
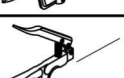

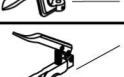
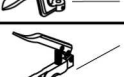





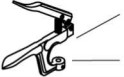
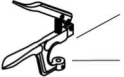









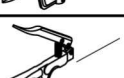
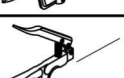

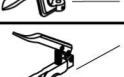
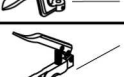





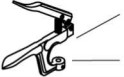
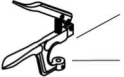





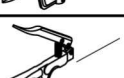
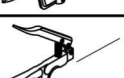

(DK)

TRYKKNAPSÆT MED TANG

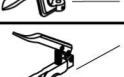
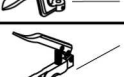
Monteringsvejledning

IAN 354162_2010

(GB) (IE) (NI) (FR) (BE)
(NL) (DK) (DE) (AT) (CH)

<p>You will need: Auxiliaires nécessaires: U hebt nodig: Du skal bruge: Sie benötigen:</p> 	<p>Tool: Outil: Tool: Værktøj: Werkzeug:</p> 																																										
<p>Buttons: Boutons: Buttons: Knapper: Druckknöpfe:</p>	<table border="1"> <tr> <td data-bbox="502 267 678 322">A </td> <td data-bbox="683 267 854 322"></td> <td data-bbox="502 329 678 384">M </td> <td data-bbox="683 329 854 384"></td> </tr> <tr> <td data-bbox="502 391 678 445">5 </td> <td data-bbox="683 391 854 445"></td> <td data-bbox="502 452 678 507">8 </td> <td data-bbox="683 452 854 507"></td> </tr> <tr> <td data-bbox="683 267 854 322">a </td> <td data-bbox="683 329 854 384"></td> <td data-bbox="683 391 854 445">P3 </td> <td data-bbox="683 452 854 507"></td> </tr> <tr> <td data-bbox="683 514 854 569">P5 </td> <td data-bbox="683 576 854 631"></td> <td data-bbox="683 637 854 692">P8 </td> <td data-bbox="683 699 854 754"></td> </tr> <tr> <td data-bbox="502 528 678 583">1 </td> <td data-bbox="683 528 854 583">20x</td> <td data-bbox="502 589 678 644">3 </td> <td data-bbox="683 589 854 644">20x</td> </tr> <tr> <td data-bbox="502 651 678 706">5 </td> <td data-bbox="683 651 854 706">160x</td> <td data-bbox="502 713 678 768">6 </td> <td data-bbox="683 713 854 768">80x</td> </tr> <tr> <td data-bbox="502 775 678 830">2 </td> <td data-bbox="683 775 854 830">20x</td> <td data-bbox="502 836 678 891">7 </td> <td data-bbox="683 836 854 891">80x</td> </tr> </table>	A 		M 		5 		8 		a 		P3 		P5 		P8 		1 	20x	3 	20x	5 	160x	6 	80x	2 	20x	7 	80x														
A 		M 																																									
5 		8 																																									
a 		P3 																																									
P5 		P8 																																									
1 	20x	3 	20x																																								
5 	160x	6 	80x																																								
2 	20x	7 	80x																																								
<p>Combinations: Combinaisons: Combinaties: Kombinationer: Kombinationen:</p>	<table border="1"> <tr> <td data-bbox="315 727 492 816">  </td> <td data-bbox="502 727 523 816">A</td> <td data-bbox="523 727 606 816"></td> <td data-bbox="606 727 626 816">=</td> <td data-bbox="626 727 709 816">3 </td> <td data-bbox="709 727 854 816"></td> </tr> <tr> <td data-bbox="315 816 492 905">  </td> <td data-bbox="502 816 523 905">a</td> <td data-bbox="523 816 606 905"></td> <td data-bbox="606 816 626 905">=</td> <td data-bbox="626 816 709 905">4 </td> <td data-bbox="709 816 854 905"></td> </tr> <tr> <td data-bbox="315 905 492 994">  </td> <td data-bbox="502 905 523 994">M</td> <td data-bbox="523 905 606 994"></td> <td data-bbox="606 905 626 994">=</td> <td data-bbox="626 905 709 994">2 </td> <td data-bbox="709 905 854 994"></td> </tr> <tr> <td data-bbox="315 994 492 1083">  </td> <td data-bbox="502 994 523 1083">P5</td> <td data-bbox="523 994 606 1083"></td> <td data-bbox="606 994 626 1083">=</td> <td data-bbox="626 994 709 1083">1 </td> <td data-bbox="709 994 854 1083"></td> </tr> <tr> <td data-bbox="315 1083 492 1173">  </td> <td data-bbox="502 1083 523 1173">5</td> <td data-bbox="523 1083 606 1173"></td> <td data-bbox="606 1083 626 1173">=</td> <td data-bbox="626 1083 709 1173">6/7 </td> <td data-bbox="709 1083 854 1173">T5 $\geq \varnothing 12\text{mm}$</td> </tr> <tr> <td data-bbox="315 1173 492 1262">  </td> <td data-bbox="502 1173 523 1262">5</td> <td data-bbox="523 1173 606 1262"></td> <td data-bbox="606 1173 626 1262">=</td> <td data-bbox="626 1173 709 1262">—</td> <td data-bbox="709 1173 854 1262">T3 $\geq \varnothing 10\text{mm}$</td> </tr> <tr> <td data-bbox="315 1262 492 1351">  </td> <td data-bbox="502 1262 523 1351">8</td> <td data-bbox="523 1262 606 1351"></td> <td data-bbox="606 1262 626 1351">=</td> <td data-bbox="626 1262 709 1351">—</td> <td data-bbox="709 1262 854 1351">T8 $\geq \varnothing 15\text{mm}$</td> </tr> </table>		A		=	3 			a		=	4 			M		=	2 			P5		=	1 			5		=	6/7 	T5 $\geq \varnothing 12\text{mm}$		5		=	—	T3 $\geq \varnothing 10\text{mm}$		8		=	—	T8 $\geq \varnothing 15\text{mm}$
	A		=	3 																																							
	a		=	4 																																							
	M		=	2 																																							
	P5		=	1 																																							
	5		=	6/7 	T5 $\geq \varnothing 12\text{mm}$																																						
	5		=	—	T3 $\geq \varnothing 10\text{mm}$																																						
	8		=	—	T8 $\geq \varnothing 15\text{mm}$																																						

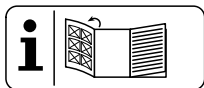

GB **IE** **NI**

Before reading, unfold the page containing the illustrations and familiarise yourself with all functions of the device.

FR **BE**

Avant de lire, dévoilez la page avec les illustrations et familiarisezvous avec toutes les fonctions de l'unité.

NL **BE**

Voordat u leest, ontvouw de pagina met de illustraties en maak u vertrouwd met alle functies van het apparaat.

DK

Før du læser, udfolder du siden med illustrationerne og gør dig bekendt med alle funktioner i enheden.

DE **AT** **CH**

Klappen Sie vor dem Lesen die Seite mit den Abbildungen aus und machen Sie sich anschließend mit allen Funktionen des Gerätes vertraut.

GB / IE / NI	Operation and Safety Notes	Page	2
FR / BE	Instructions d'utilisation et de sécurité	Page	5
NL / BE	Bedieningsen veiligheidsinstructies	Page	8
DK	Drifts- og sikkerhedsanvisninger	Side	11
DE / AT / CH	Bedienungs- und Sicherheitshinweise	Seite	14

Content

Delivery.....	Page	II
Introduction.....	Page	3
Intended Use.....	Page	3
Safety instructions.....	Page	3
Other notes.....	Page	3
Change stamp.....	Page	17
Preparation of the fabric.....	Page	19
Fixing metal buttons.....	Page	20
Attachment of plastic buttons.....	Page	21
Cleaning and care.....	Page	3
Disposal.....	Page	4
Service.....	Page	4

Introduction

We congratulate you on the purchase of your new product. You have chosen a high quality product. The operating instructions are part of this product. It contains important instructions for safety, use and disposal.

Before using the product, familiarize yourself with all controls Safety instructions familiar. Use the product only as described and for the specified areas of application. When hand over the product to another person, please include the instructions for use.

Intended Use

The push-button pliers set is only suitable for fastening press studs in fabric up to 2.5 mm thick. The product is not for the commercialUse or for other applications.

Safety instructions

- No toy! Keep children away from the product.
- Be careful not to pinch your fingers while using the pliers.

Other notes

The push buttons are machine washable up to 60 ° C. Suitable for fabrics up to 2.5 mm thick (for example jersey or fleece). For thin or elastic fabrics, work in non-woven fabric on both sides for reinforcement.

Cleaning and care

Clean the product only externally with a soft, dry or light moistened cloth. Do not use abrasive or corrosive agents or brushes or the like for cleaning.

Disposal

For disposal, the local, official regulations must be observed. Dispose of the packaging sorted in the designated collection containers..

Service

This product is subject to strict quality assurance. Should still be a defect please contact our customer service. For the free processing of a warranty service, it is absolutely necessary the proof of purchase store.

Qsource GmbH, Auguste-Baur-Str. 1, D-22587 Hamburg,

Tel. +49-40-87932653, Fax +49-40-87932637,

E-Mail: service@qsource.de

You can reach us Monday to Friday from 8:00 AM to 4:00 PM.

Conten

Livraison.....	Page	II
Introduction.....	Page	6
Usage prévu.....	Page	6
Sécurité.....	Page	6
Autres notes.....	Page	6
Changer de tampon.....	Page	17
Préparation du tissu.....	Page	19
Fixation des boutons en métal.....	Page	20
Fixation de boutons en plastique.....	Page	21
Nettoyage et entretien.....	Page	6
Disposition.....	Page	7
Service.....	Page	7

Introduction

Nous vous félicitons pour l'achat de votre nouveau produit. Vous avez choisi un produit de haute qualité. Les instructions d'utilisation font partie de ce produit. Il contient des instructions importantes pour la sécurité, l'utilisation et la mise au rebut.

Avant d'utiliser le produit, familiarisez-vous avec toutes les commandes. Consignes de sécurité familières. Utilisez le produit uniquement comme décrit et pour le domaines d'application spécifiés. Lors de la distribution du produit, veuillez inclure les instructions d'utilisation.

Usage prévu

La pince à boutons convient uniquement à la fixation de boutons-pression en tissu jusqu'à 2,5 mm d'épaisseur. Le produit n'est pas pour le commercial Utilisez ou pour d'autres applications.

Sécurité

- Pas de jouets! Gardez les enfants à l'écart du produit.
- Veillez à ne pas vous pincer les doigts lorsque vous utilisez la pince.

Autres notes

Les boutons-poussoirs sont lavables en machine à 60 ° C.

Convient aux tissus jusqu'à 2,5 mm d'épaisseur (par exemple, jersey ou polaire). Pour les tissus minces ou élastiques, travaillez en non-tissé des deux côtés pour renforcer.

Nettoyage et entretien

Nettoyez le produit uniquement à l'extérieur avec un chiffon doux, sec ou léger chiffon humide. N'utilisez pas d'agents abrasifs ou corrosifs, ni de brosses, etc., pour le nettoyage.

Disposition

Pour l'élimination, les règlements locaux et officiels doivent être observés.
Jetez l'emballage dans les conteneurs de collecte désignés.

Service

Ce produit est soumis à une assurance qualité stricte. Devrait encore être un défaut veuillez contacter notre service clientèle. Pour le Traitement gratuit d'un service de garantie, la preuve d'achat est indispensable magasin.

Qsource GmbH, Auguste-Baur-Str. 1, D-22587 Hamburg,
tél. : 0049/40/87932653, fax 0049/40/87932637,
e-mail : service@qsource.de

Vous pouvez nous joindre du lundi au vendredi entre
8 h et 16 h.

Inhoud

Levering.....	Page	II
Introductie.....	Page	9
Beoogd gebruik.....	Page	9
Veiligheid.....	Page	9
Andere opmerkingen.....	Page	9
Stempel wijzigen.....	Page	17
Vorbereiding van de stof.....	Page	19
Metalen knopen bevestigen.....	Page	20
Bevestiging van plastic knoppen.....	Page	21
Reiniging en verzorging.....	Page	9
Beschikking.....	Page	10
Service.....	Page	10

Introductie

We feliciteren u met de aankoop van uw nieuwe product. U hebt gekozen voor een product van hoge kwaliteit. De gebruiksaanwijzing maakt deel uit van dit product. Het bevat belangrijke instructies voor veiligheid, gebruik en verwijdering.

Maak uzelf vertrouwd met alle bedieningselementen voordat u het product gebruikt. Veiligheidsinstructies bekend. Gebruik het product alleen zoals beschreven en voor de specifieke toepassingsgebieden. Vermeld bij het distribueren van het product de gebruiksaanwijzing.

Beoogd gebruik

De tiktang ingesteld is alleen geschikt voor het bevestigen van drukknoppen in stof tot 2,5 mm dik. Het product is niet voor de commercial Gebruik of voor andere toepassingen.

Veiligheid

- Geen speelgoed! Houd kinderen uit de buurt van het product.
- Pas op dat u uw vingers niet knelt tijdens het gebruik van de tang.

Andere opmerkingen

De drukknoppen zijn wasbaar in de machine tot 60 ° C.

Geschikt voor stoffen tot 2,5 mm dik (bijv. Jersey of fleece). Voor dunne of elastische stoffen, werk aan beide zijden in niet-geweven stof ter versterking.

Reiniging en verzorging

Reinig het product alleen extern met een zachte, droge of lichte bevochtigde doek. Gebruik geen schurende of bijtende middelen of borstels en dergelijke om te reinigen.

Beschikking

Voor verwijdering moeten de lokale, officiële voorschriften in acht worden genomen.

Gooi de verpakking gesorteerd in de daarvoor bestemde verzamelcontainers.

Service

Dit product is onderhevig aan strikte kwaliteitsborging. Moet nog steeds een defect zijn

neem contact op met onze klantenservice. Voor de Gratis verwerking van een garantieservice, het is absoluut noodzakelijk het aankoopbewijs store.

Qsource GmbH, Auguste-Baur-Str. 1, D-22587 Hamburg,

Tel.: 0049/40/87932653, fax 0049/40/87932637,

e-mail: service@qsource.de

U bereikt ons van maandag - vrijdag van 8.00 - 16.00 uur.



Indhold

Levering.....	Side	11
Introduktion.....	Side	12
Tiltænkt brug.....	Side	12
Sikkerhed.....	Side	12
Andre noter.....	Side	12
Skift stempel.....	Side	17
Forberedelse af stoffet.....	Side	19
Fastgørelse af metal knapper.....	Side	20
Vedhæftning af plastik knapper.....	Side	21
Rengøring og pleje.....	Side	12
Bortskaffelse.....	Side	13
Service.....	Side	13

Introduktion

Vi lykønsker dig med køb af dit nye produkt. Du har valgt et produkt af høj kvalitet. Betjeningsvejledningen er en del af dette produkt. Det indeholder vigtige instruktioner vedrørende sikkerhed, brug og bortskaffelse.

Før du bruger produktet, skal du gøre dig bekendt med alle kontroller Sikkerhedsinstruktioner kendt. Brug kun produktet som beskrevet og til specificerede anvendelsesområder. Når du distribuerer produktet, skal du medtage instruktionerne til brug.

Tiltænkt brug

Tastaturet indstilles er kun egnet til fastgørelsestryk i stof op til 2,5 mm tykt. Produktet er ikke til kommercielt Brug eller til andre applikationer.

Sikkerhed

- Ingen legetøj! Hold børn væk fra produktet.
- Pas på ikke at klemme fingrene, mens du bruger tangen.

Andre noter

Trykknapperne kan vaskes op til 60 ° C.

Velegnet til stof op til 2,5 mm tykt (fx jersey eller fleece). For tynde eller elastiske stoffer, arbejde i non-woven stof på begge sider for forstærkning.

Rengøring og pleje

Rengør kun produktet eksternt med en blød, tør eller lys fugtig klud. Brug ikke slibende eller ætsende stoffer eller børster eller lignende til rengøring.

Bortskaffelse

Til bortskaffelse skal de lokale, officielle regler overholdes.
Bortskaf emballagen sorteret i de udpegede opsamlingsbeholdere.

Service

Dette produkt er underlagt strenge kvalitetssikringer. Skulle stadig være en defekt

Kontakt venligst vores kundeservice. For Fri behandling af en garantiservice, det er absolut nødvendigt bevis for køb butik.

Qsource GmbH, Auguste-Baur-Str. 1, D-22587 Hamburg,

Tel.: 0049/40/87932653, Fax: 0049/40/87932637,

E-mail: service@qsource.de

Du kan nå os mandag til fredag fra kl. 8.00 til 16.00.

Inhalt

Lieferumfang.....	Seite	II
Einleitung.....	Seite	15
Bestimmungsgemäßer Gebrauch.....	Seite	15
Sicherheitshinweise.....	Seite	15
Sonstige Hinweise.....	Seite	15
Stempel wechseln.....	Seite	17
Vorbereitung des Stoffgewebes.....	Seite	19
Befestigung von Metallknöpfen.....	Seite	20
Befestigung von Kunststoffknöpfen.....	Seite	21
Reinigung und Pflege.....	Seite	15
Entsorgung.....	Seite	16
Service.....	Seite	16

Einleitung

Wir beglückwünschen Sie zum Kauf Ihres neuen Produkts. Sie haben sich damit für ein hochwertiges Produkt entschieden. Die Bedienungsanleitung ist Teil dieses Produkts. Sie enthält wichtige Hinweise für Sicherheit, Gebrauch und Entsorgung.

Machen Sie sich vor der Benutzung des Produkts mit allen Bedien- und Sicherheitshinweisen vertraut. Benutzen Sie das Produkt nur wie beschrieben und für die angegebenen Einsatzbereiche. Bei einer Weitergabe des Produkts geben Sie die Gebrauchsanleitung mit.

Bestimmungsgemäßer Gebrauch

Das Druckknopfzangen-Set ist ausschließlich zur Befestigung von Druckknöpfen in Stoffgeweben bis ca. 2,5 mm Dicke geeignet. Das Produkt ist nicht für den gewerblichen Einsatz oder für andere Einsatzbereiche bestimmt.

Sicherheitshinweise

- Kein Spielzeug! Halten Sie Kinder von dem Produkt fern.
- Achten Sie darauf, dass Sie Ihre Finger beim Gebrauch der Zange nicht klemmen.

Sonstige Hinweise

Die Druckknöpfe sind maschinenwaschbar bis 60°C.

Geeignet für Stoffe bis ca. 2,5 mm Dicke (z.B. Jersey oder Fleece). Bei dünnen oder elastischen Stoffen beidseitig Vliesline zur Verstärkung einarbeiten.

Reinigung und Pflege

Reinigen Sie das Produkt nur äußerlich mit einem weichen, trockenen oder leicht angefeuchteten Tuch. Verwenden Sie zum Reinigen keine scheuernden oder ätzenden Mittel bzw. Bürsten oder ähnliches.

Entsorgung

Für die Entsorgung sind die örtlichen, behördlichen Vorschriften zu beachten.

Entsorgen Sie die Verpackung sortenrein in den dafür vorgesehenen Sammelbehältern.

Service

Dieses Produkt unterliegt einer strengen Qualitätssicherung. Sollte dennoch ein Mangel auftreten, so bitten wir um Kontaktaufnahme mit unserem Kundendienst. Für die kostenlose Bearbeitung einer Garantieleistung ist es unbedingt erforderlich den Kaufbeleg aufzubewahren.

Qsource GmbH, Auguste-Baur-Str. 1, D-22587 Hamburg,
Tel.: 0049/40/87932653, Fax: 0049/40/87932637,
E-Mail: service@qsource.de

Sie erreichen uns Montag - Freitag von 8.00 - 16.00 Uhr.

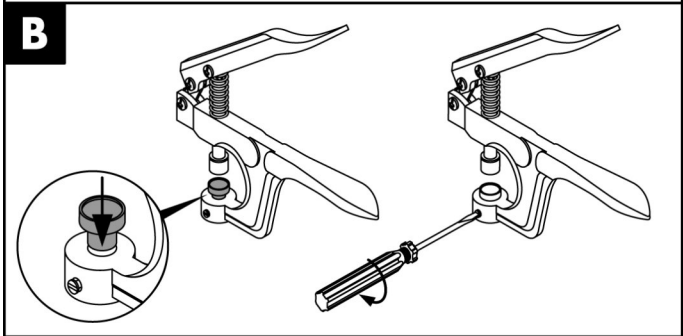
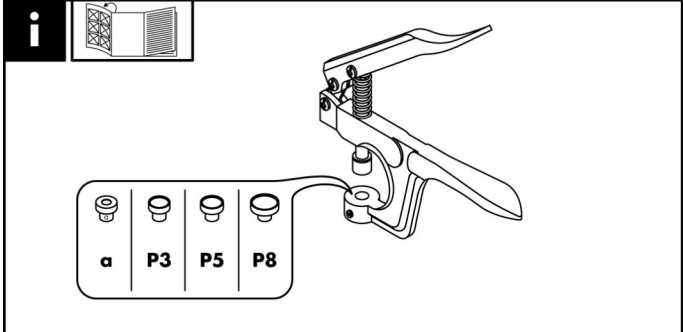
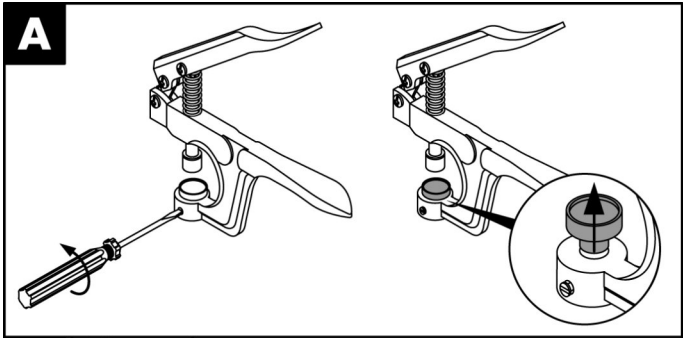

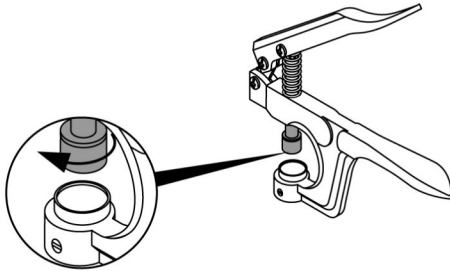
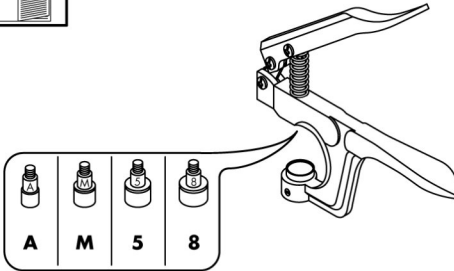
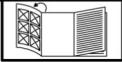
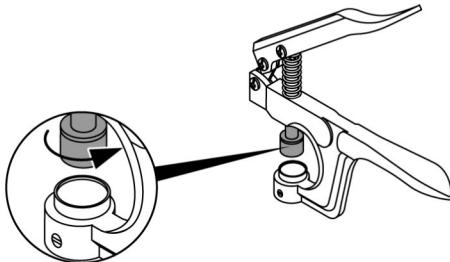
C**i****D**

i

GB

Be careful. Push buttons cannot be moved non-destructively.

FR / BE

Soyez prudent. Les boutons-poussoirs ne peuvent pas être déplacés de manière non destructive.

NL / BE

Wees voorzichtig. Drukknoppen kunnen niet niet-destructief worden verplaatst.

DK

Vær forsigtig. Trykknapper kan ikke flyttes ikke-destruktiv.

DE / AT / CH

Gehen Sie sorgfältig vor. Druckknöpfe können nicht zerstörungsfrei versetzt werden.

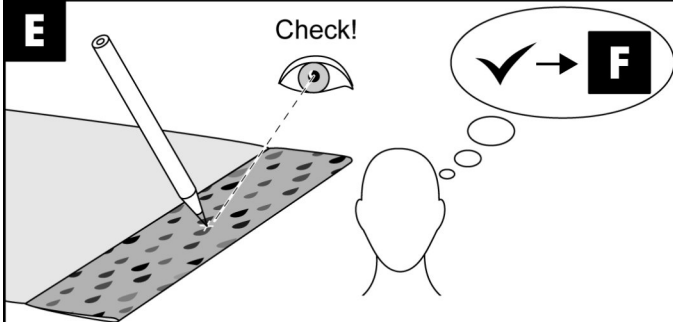
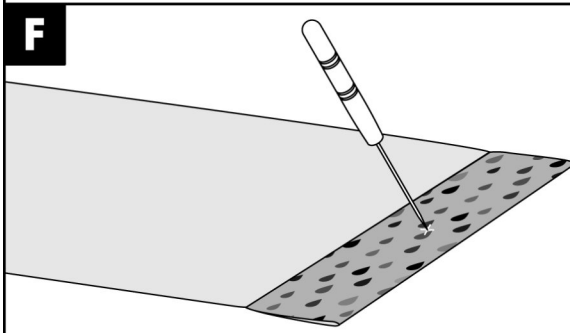
E**F**

i

G

H

Metal
Métal
Metaal
Metal
Metall

G

1



2

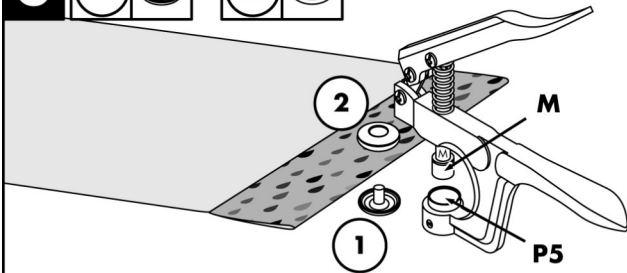

H

3



4

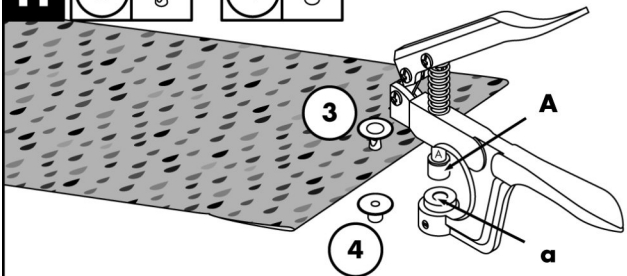

i

I

J

Plastic
Plastique
Plastic
Plast
Kunststoff

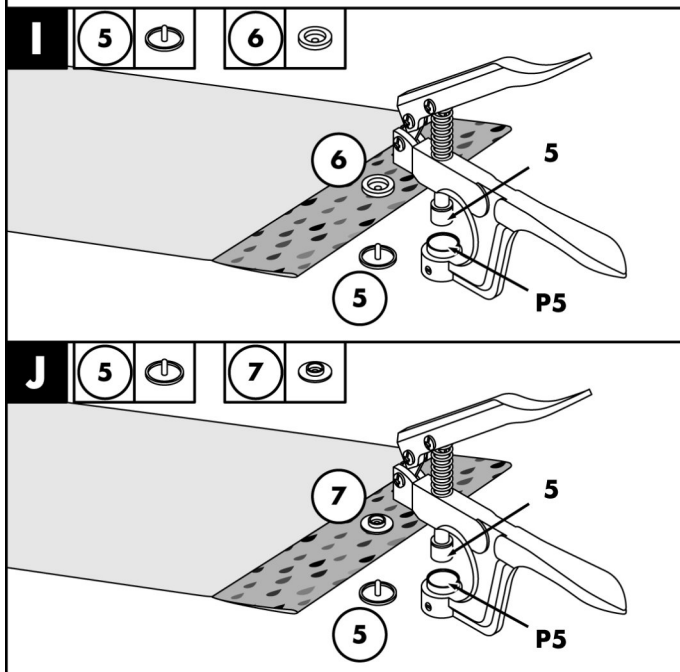

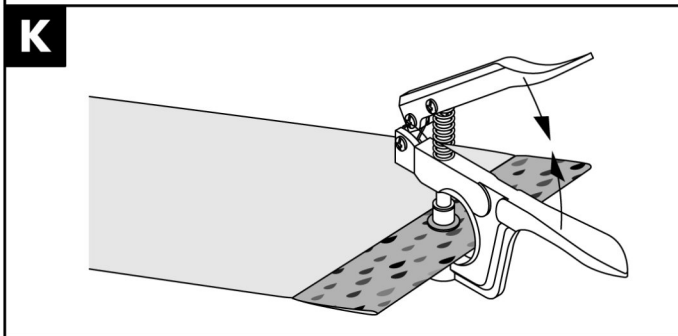
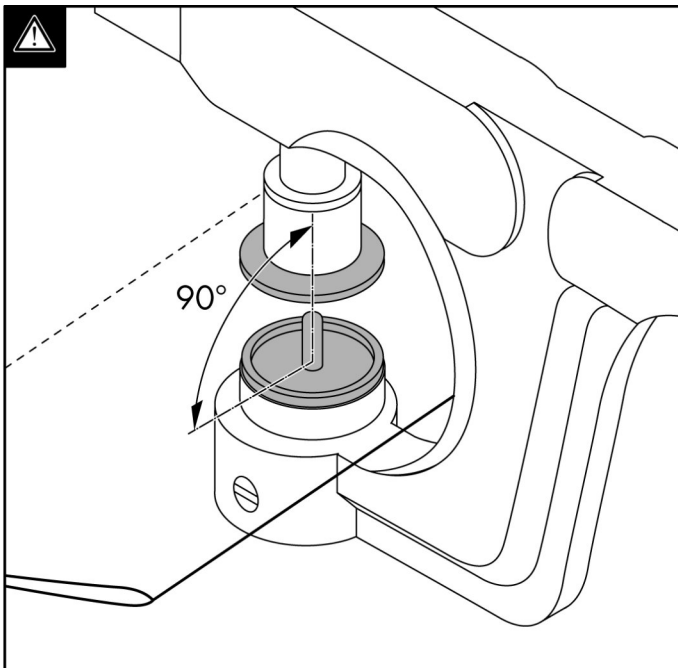

for EU market:

Qsource GmbH

Auguste-Baur-Str. 1

D-22587 Hamburg

for GB market:

Lidl Great Britain Ltd, Lidl House,

14 Kingston Road, Surbiton, KT5 9NU

Stand der Informationen · Version des informations

Versione delle informazioni · Last information Update:

12 / 2020

Ident.-No.: QSD2020L06354162_2010

IAN 354162_2010

