



WOHNMOBIL

DE AT CH

WOHNMOBIL

Gebrauchsanweisung

FR CH

CAMPING-CAR

Notice d'utilisation

IT CH

CAMPER

Istruzioni d'uso

GB

CAMPERVAN

Instructions for use

IAN 432957_2301



DE AT CH
FR IT GB



DELTA-SPORT HANDELSKONTOR GMBH
Wragekamp 6 • DE-22397 Hamburg
GERMANY

© 2023 KIDDINX Studios GmbH, Berlin
Lizenz durch KIDDINX Media GmbH
Lahnstraße 21, 12055 Berlin, Deutschland
www.bibiundtina.de

06/2023
Delta-SportNr.: CL-12825

IAN 432957_2301

Herzlichen Glückwunsch!

Mit Ihrem Kauf haben Sie sich für einen hochwertigen Artikel entschieden. Machen Sie sich vor der ersten Verwendung mit dem Artikel vertraut.

Lesen Sie hierzu aufmerksam die nachfolgende Gebrauchsanweisung.

Benutzen Sie den Artikel nur wie beschrieben und für die angegebenen Einsatzbereiche. Bewahren Sie diese Gebrauchsanweisung gut auf. Händigen Sie alle Unterlagen bei Weitergabe des Artikels an Dritte ebenfalls mit aus.

Lieferumfang

- 481 x Einzelteil
- 1 x Stickerbogen
- 1 x Aufbauanleitung
- 1 x Gebrauchsanweisung

Technische Daten

Herstellungsdatum (Monat/Jahr): 06/2023

Hiermit erklärt Delta-Sport Handelskontor GmbH, dass dieser Artikel mit den folgenden grundlegenden Anforderungen und den übrigen einschlägigen Bestimmungen übereinstimmt:

2009/48/EG - Spielzeug-Richtlinie

Bestimmungsgemäße Verwendung

Dieser Artikel ist ein Spielzeug für Kinder ab 5 Jahren für den privaten Gebrauch.

Sicherheitshinweise

- Achtung. Nicht für Kinder unter 36 Monaten geeignet. Erstickungsgefahr. Kleine Teile.
- Kinder dürfen nur unter Aufsicht von Erwachsenen mit dem Artikel spielen.
- Achtung. Alle Verpackungs- und Befestigungsmaterialien sind nicht Bestandteil des Spielzeugs und müssen aus Sicherheitsgründen stets entfernt werden, bevor der Artikel Kindern zum Spielen übergeben wird.
- Prüfen Sie den Artikel vor jedem Gebrauch auf Beschädigungen oder Abnutzungen. Der Artikel darf nur in einwandfreiem Zustand verwendet werden!

Lagerung, Reinigung

Lagern Sie den Artikel bei Nichtbenutzung immer trocken und sauber bei Raumtemperatur. Nur mit einem trockenen Reinigungstuch sauber wischen. WICHTIG! Nie mit scharfen Reinigungsmitteln reinigen.

Hinweise zur Entsorgung

Entsorgen Sie den Artikel und die Verpackungsmaterialien entsprechend den aktuellen örtlichen Vorschriften. Bewahren Sie Verpackungsmaterialien (wie z. B. Folienbeutel) für Kinder unerreichbar auf.

Weitere Informationen zur Entsorgung des ausgedienten Artikels erhalten Sie bei Ihrer Gemeinde- oder Stadtverwaltung. Entsorgen Sie den Artikel und die Verpackung umweltschonend.



Der Recycling-Code dient der Kennzeichnung verschiedener Materialien zur Rückführung in den Wiederverwertungskreislauf (Recycling). Der Code besteht aus einem Recyclingsymbol für den Verwertungskreislauf und einer Nummer, die das Material kennzeichnet.

Hinweise zur Garantie und Serviceabwicklung

Der Artikel wurde mit großer Sorgfalt und unter ständiger Kontrolle produziert. DELTA-SPORT HANDELSKONTOR GmbH räumt privaten Endkunden auf diesen Artikel drei Jahre Garantie ab Kaufdatum (Garantiefrist) nach Maßgabe der folgenden Bestimmungen ein. Die Garantie gilt nur für Material- und Verarbeitungsfehler. Die Garantie erstreckt sich nicht auf Teile, die der normalen Abnutzung unterliegen und deshalb als Verschleißteile anzusehen sind (z. B. Batterien) sowie nicht auf zerbrechliche Teile, z. B. Schalter, Akkus oder Teile, die aus Glas gefertigt sind.

Ansprüche aus dieser Garantie sind ausgeschlossen, wenn der Artikel unsachgemäß oder missbräuchlich oder nicht im Rahmen der vorgesehenen Bestimmung oder des vorgesehenen Nutzungsumfanges verwendet wurde oder Vorgaben in der Anleitung/Anweisung nicht beachtet wurden, es sei denn, der Endkunde weist nach, dass ein Material- oder Verarbeitungsfehler vorliegt, der nicht auf einem der vorgenannten Umstände beruht.

Ansprüche aus der Garantie können nur innerhalb der Garantiefrist unter Vorlage des Originalkassenbelegs geltend gemacht werden. Bitte bewahren Sie deshalb den Originalkassenbeleg auf.

Die Garantiefrist wird durch etwaige Reparaturen aufgrund der Garantie, gesetzlicher Gewährleistung oder Kulanz nicht verlängert. Dies gilt auch für ersetzte und reparierte Teile. Bitte wenden Sie sich bei Beanstandungen zunächst an die untenstehende Service-Hotline oder setzen Sie sich per E-Mail mit uns in Verbindung. Liegt ein Garantiefall vor, wird der Artikel von uns - nach unserer Wahl - für Sie kostenlos repariert, ersetzt oder der Kaufpreis erstattet. Weitere Rechte aus der Garantie bestehen nicht.

DE/AT/CH

DE/AT/CH

DE/AT/CH

Félicitations !

Vous venez d'acquérir un article de grande qualité. Avant la première utilisation, familiarisez-vous avec l'article.

Pour cela, veuillez lire attentivement la notice d'utilisation suivante.

Utilisez l'article uniquement comme indiqué et pour les domaines d'utilisation mentionnés. Conservez bien cette notice d'utilisation. Si vous cédez l'article à un tiers, veuillez à lui remettre l'ensemble de la documentation.

Contenu de la livraison

- 481 pièces
- 1 feuille d'autocollants
- 1 notice de montage
- 1 notice d'utilisation

Données techniques

Date de fabrication (mois/année) : 06/2023

Delta-Sport Handelskontor GmbH déclare par la présente que cet article répond aux exigences essentielles et aux autres dispositions en vigueur suivantes :

2009/48/CE - Directive relative à la sécurité des jouets

Utilisation conforme

Cet article est un jouet pour enfants à partir de 5 ans destiné à un usage privé.

Instructions de sécurité

- Attention. Ne convient pas aux enfants de moins de 36 mois. Danger d'étouffement. Petites balles.
- Les enfants ne doivent jouer avec l'article que sous la surveillance d'adultes.
- Attention. Les matériaux d'emballage et de fixation ne font pas partie du jouet et doivent toujours être enlevés pour des raisons de sécurité avant que le produit ne soit remis aux enfants pour jouer.
- Avant la première utilisation, veuillez vérifier que l'article ne présente aucun dommage ni signe d'usure. L'article ne doit être utilisé que dans un parfait état !

Stockage, nettoyage

Lorsque vous n'utilisez pas l'article, rangez-le toujours dans un endroit sec et propre à une température ambiante. Essayez uniquement avec un chiffon de nettoyage à sec. IMPORTANT ! Ne jamais laver avec des produits de nettoyage agressifs.

Mise au rebut

Ce produit est recyclable. Il est soumis à la responsabilité élargie du fabricant et est collecté séparément.

Éliminez le produit et les matériaux d'emballage conformément aux réglementations locales actuelles en vigueur. Conservez les matériaux d'emballage (comme les sachets en plastique) hors de portée des enfants. Vous obtiendrez plus d'informations relatives à l'élimination du produit usagé auprès de votre commune ou de votre municipalité. Éliminez le produit et l'emballage dans le respect de l'environnement.

Le code de recyclage est utilisé pour identifier les différents matériaux à retourner dans le cycle de recyclage. Ce code se compose du symbole de recyclage, représentant le cycle de recyclage ainsi que d'un numéro identifiant le matériau.

Indications concernant la garantie et le service après-vente

L'article a été produit avec grand soin et sous un contrôle constant. DELTA-SPORT HANDELSKONTOR GmbH accorde au client final privé une garantie de trois ans sur cet article à compter de la date d'achat (période de garantie) conformément aux dispositions suivantes. La garantie ne vaut que pour les défauts de matériaux et de fabrication. La garantie ne couvre pas les pièces soumises à une usure normale, lesquelles doivent donc être considérées comme des pièces d'usure (comme par ex. les piles), de même qu'elle ne couvre pas les pièces fragiles, telles que les interrupteurs, les batteries ou les pièces fabriquées en verre. Les réclamations au titre de cette garantie sont exclues si l'article a été utilisé de manière abusive ou inappropriée, hors du cadre de son usage ou du champ d'application prévu ou si les instructions de la notice d'utilisation n'ont pas été respectées, à moins que le client final ne prouve que l'article présentait un défaut de matériau ou de fabrication n'étant pas dû à l'une des conditions mentionnées ci-dessus. Les réclamations au titre de la garantie ne peuvent être adressées pendant la période de garantie qu'en présentant le ticket de caisse original. Veuillez pour cela conserver le ticket de caisse original. Ceci s'applique également aux pièces remplacées et réparées.

Leur droits légaux, en particulier les droits de garantie contre le vendeur concerné, ne sont pas limités par cette garantie.

IAN: 432957_2301

DE Kundenservice Deutschland

Tel.: 0800 5435 111
E-Mail: deltasport@lidl.de

AT Service Österreich

Tel.: 0800 447744
E-Mail: deltasport@lidl.at

CH Service Schweiz

Tel.: 0800 56 44 33
E-Mail: deltasport@lidl.ch

Si vous avez des plaintes à formuler, veuillez d'abord contacter le service d'assistance téléphonique ci-dessous ou nous contacter par courrier électronique. Si le cas est couvert par la garantie, nous nous engageons - à notre appréciation - à réparer ou à remplacer l'article gratuitement pour vous ou à vous rembourser le prix d'achat. Aucun autre droit ne découle de la garantie.

Vos droits légaux, en particulier les droits de garantie contre le vendeur concerné, ne sont pas limités par cette garantie.

Article L217-16 du Code de la consommation

Lorsque l'acheteur demande au vendeur, pendant le cours de la garantie commerciale qui lui a été consentie lors de l'acquisition ou de la réparation d'un bien meuble, une remise en état couverte par la garantie, toute période d'immobilisation d'au moins sept jours vient s'ajouter à la durée de la garantie qui restait à courir.

Cette période court à compter de la demande d'intervention de l'acheteur ou de la mise à disposition pour réparation du bien en cause, si cette mise à disposition est postérieure à la demande d'intervention.

Indépendamment de la garantie commerciale souscrite, le vendeur reste tenu des défauts de conformité du bien et des vices rédhibitoires dans les conditions prévues aux articles L217-4 à L217-13 du Code de la consommation et aux articles 1641 à 1648 et 2232 du Code Civil.

Article L217-4 du Code de la consommation

Le vendeur livre un bien conforme au contrat et répond des défauts de conformité existant lors de la délivrance. Il répond également des défauts de conformité résultant de l'emballage, des instructions de montage ou de l'installation lorsque celle-ci a été mise à sa charge par le contrat ou a été réalisée sous sa responsabilité.

Article L217-5 du Code de la consommation

Le bien est conforme au contrat :
1° S'il est propre à l'usage habituellement attendu d'un bien semblable et, le cas échéant :
• s'il correspond à la description donnée par le vendeur et possède les qualités que celui-ci a présentées à l'acheteur sous forme d'échantillon ou de modèle ;
• s'il présente les qualités qu'un acheteur peut légitimement attendre eu égard aux déclarations publiques faites par le vendeur, par le producteur ou par son représentant, notamment dans la publicité ou l'étiquetage ;
2° Ou s'il présente les caractéristiques définies d'un commun accord par les parties ou être propre à tout usage spécial recherché par l'acheteur, porté à la connaissance du vendeur et que ce dernier a accepté.

Article L217-12 du Code de la consommation

L’action résultant du défaut de conformité se prescrit par deux ans à compter de la délivrance du bien.

Article 1641 du Code civil

Le vendeur est tenu de la garantie à raison des défauts cachés de la chose vendue qui la rendent impropres à l’usage auquel on la destine, ou qui diminuent tellement cet usage que l’acheteur ne l’aurait pas acquise, ou n’en aurait donné qu’un moindre prix, s’il les avait connus.

Article 1648 1er alinéa du Code civil

L’action résultant des vices rédhibitoires doit être intentée par l’acquéreur dans un délai de deux ans à compter de la découverte du vice.

Les pièces détachées indispensables à l’utilisation du produit sont disponibles pendant la durée de la garantie du produit.

IAN : 432957_2301

Service Suisse

Tel.: 0800 56 44 33

E-Mail : deltasport@lidl.ch

Congratulations!

Avete acquistato un articolo di alta qualità. Consigliamo di familiarizzare con l’articolo prima di cominciare ad utilizzarlo.

Leggere attentamente le seguenti istruzioni d’uso.

Utilizzare l’articolo solo nel modo descritto e per gli ambiti di applicazione indicati. Conservare accuratamente queste istruzioni d’uso. In caso di trasferimento dell’articolo a terzi, consegnare tutti i documenti insieme all’articolo.

Contenuto della confezione

CL-12825
481 x singolo pezzo

- 1 x foglio adesivi
- 1 x istruzioni di montaggio
- 1 x istruzioni d’uso

Dati tecnici

Date di produzione (anno/mese): 06/2023

Con la presente Delta-Sport Handelskontor GmbH dichiara che questo articolo è conforme ai seguenti requisiti di base e alle altre disposizioni vigenti:

2009/48/CE – Direttiva sulla sicurezza dei giocattoli

Utilizzo conforme

Questo articolo è un giocattolo per l’uso privato per bambini dai 5 anni in su.

Avvertenze di sicurezza

- Avvertenza. Non adatto a bambini di età inferiore a 36 mesi. Rischio di soffocamento. Piccole palle.
- I bambini possono giocare con l’articolo solo se sorvegliati da persone adulte.
- Avvertenza. Tutti i materiali della confezione e dei fissaggi non sono parte integrante del giocattolo e per motivi di sicurezza devono sempre essere tolti prima di affidare il prodotto ai bambini che ci giocheranno.
- Prima di ciascun utilizzo, verificare che l’articolo non presenti danni o segni di usura. L’articolo può essere utilizzato solo se in perfetto stato!

Conservazione, pulizia

In caso di mancato utilizzo, riporre l’articolo a temperatura ambiente in un luogo asciutto e pulito.

Pulire solo con un panno asciutto.

IMPORTANTE! Non utilizzare mai detergenti aggressivi.

Smaltimento

Smaltire l’articolo e i materiali della confezione nel rispetto delle attuali normative locali. Conservare i materiali della confezione (come ad es. i sacchetti) in modo che non siano raggiungibili per i bambini.

Presso la propria amministrazione comunale o cittadina è possibile ottenere ulteriori informazioni sullo smaltimento dell’articolo alla fine del suo periodo di impiego. Smaltire l’articolo e la confezione nel rispetto dell’ambiente.

Il codice di riciclaggio serve per indicare i diversi materiali per il loro ritorno al ciclo di riutilizzo (recycling). Il codice è composto da un simbolo di riciclaggio per il ciclo di riutilizzo e da un numero che contraddistingue il materiale.

Avvertenze sulla garanzia e sulla gestione dei servizi di assistenza

L’articolo è stato prodotto con la massima cura e sotto un continuo controllo. DELTA-SPORT HANDELSKONTOR GmbH concede ai clienti finali privati, su questo articolo, tre anni di garanzia dalla data di acquisto (termine di garanzia) sulla base delle seguenti disposizioni. La garanzia vale per difetti del materiale o di fabbricazione. Questa garanzia non si estende a componenti del prodotto esposti a normale logorio, che possono pertanto essere considerati come componenti soggetti a usura (esempio capacità della batteria, calcificazione, lampade, pneumatici, filtri, spazzole...). La garanzia non si estende altresì a danni che si verificano su componenti delicati (esempio interruttori, batterie, parti realizzate in vetro, schermi, accessori vari) nonché a danni derivanti dal trasporto o altri incidenti.

Dalla presente garanzia sono escluse le richieste legate a casi di utilizzo non conforme oppure di abuso dell’articolo, oppure di utilizzo avvenuto non nell’ambito delle condizioni previste oppure del campo di impiego previsto, oppure in caso di non osservanza delle direttive riportate nelle istruzioni d’uso, a meno che il cliente non dimostri che sussista un vizio di materiale o di lavorazione che non sia riconducibile ad una delle circostanze riportate sopra.

Le richieste di garanzia possono essere avanzate solo entro il relativo termine, su presentazione dello scontrino originale di acquisto. Si prega quindi di conservare lo scontrino originale. Il termine di garanzia non sarà prolungato a seguito di eventuali riparazioni effettuate sulla base della garanzia, della garanzia obbligatoria prevista per legge oppure di accondiscendenza. Ciò vale anche per le parti sostituite oppure riparate.

In caso di contestazione rivolgersi dapprima alla hotline di assistenza sotto indicata oppure mettersi in contatto con noi via e-mail. Laddove sussista un caso coperto dalla garanzia, l’articolo sarà – a nostra discrezione – da noi riparato gratuitamente, sostituito oppure sarà rimborsato il prezzo di acquisto. Non sussistono ulteriori diritti derivanti dalla garanzia.

I vostri diritti giuridici, in particolare i diritti di garanzia obbligatoria prevista dalla legge nei confronti del relativo venditore, non sono limitati dalla presente garanzia.

IAN: 432957_2301

Assistenza Svizzera

Tel.: 0800 56 44 33

E-Mail : deltasport@lidl.ch

Congratulations!

You have chosen to purchase a high-quality product. Familiarise yourself with the product before using it for the first time.

Read the following instructions for use carefully.

Use the product only as described and only for the given areas of application. Store these instructions for use carefully.

When passing the product on to third parties, please also hand over all accompanying documents.

Scope of delivery **CL-12825**

481 x parts

- 1 x sticker sheet
- 1 x assembly instructions
- 1 x instructions for use

Technical data

Date of manufacture (month/year): 06/2023

Delta-Sport Handelskontor GmbH hereby declares that this product meets the following basic requirements, as well as other important regulations:

2009/48/EC – Toy Safety Directive

UK Conformity Assessed
 Delta-Sport Handelskontor GmbH hereby declares that this product meets the following basic requirements, as well as other important regulations:

Toys (Safety) Regulations 2011

Use according to guidelines

This product is a toy for children 5 years and up for private use.

Safety Instructions

- Warning. Not suitable for children under 36 months. Choking hazard. Small balls.
- Children may play with this article only under adult supervision.
- Warning. The packaging and mounting materials are not a constituent part of the toy and they must be removed in all cases for safety reasons before the product is given to children to play with.
- Check the product for damage and wear before each use. The product may only be used in good order and condition!

FR/CH

IT/CH

IT/CH

GB

Storage, cleaning

When not in use, always store the product clean and dry at room temperature. Wipe clean with a dry cloth only.

IMPORTANT! Never clean the product with harsh cleaning agents.

Disposal

Dispose of the product and packaging materials in accordance with current local regulations. Store the packaging materials (foil bags, for example) out of the reach of children. For further information about disposal of the product no longer needed, contact your local council. Dispose of the product and the packaging in an environmentally friendly manner.

Dispose of the product and packaging materials in accordance with current local regulations. Store the packaging materials (foil bags, for example) out of the reach of children. For further information about disposal of the product no longer needed, contact your local council. Dispose of the product and the packaging in an environmentally friendly manner.

The Recycling Code distinguishes different materials to be returned for recycling. The Code consists of the recycling symbol for the recycling process and a number that identifies the material.

Notes on the guarantee and service handling

The product was produced with great care and under continuous quality control. DELTA-SPORT HANDELSKONTOR GmbH gives private end customers a three-year guarantee on this product from the date of purchase (guarantee period) in accordance with the following provisions.

The guarantee is only valid for material and manufacturing defects. The guarantee does not cover parts subject to normal wear and tear that are thus considered wear parts (e.g. batteries) or fragile parts such as switches, rechargeable batteries, or parts made of glass.

Claims under this guarantee are excluded if the product has been used incorrectly, improperly, or contrary to the intended purpose, or if the provisions in the instructions for use were not observed, unless the end customer proves that a material or manufacturing defect exists that was not caused by one of the aforementioned circumstances.

Claims under the guarantee can only be made within the guarantee period by presenting the original sales receipt. Please therefore keep the original sales receipt.

The guarantee period is not extended by any repairs carried out under the guarantee, under statutory guarantees, or as a gesture of goodwill. This also applies to replaced and repaired parts.

If you wish to make a claim please first contact the service hotline mentioned below or contact us by e-mail. If there is a guarantee case, then the product will be repaired or replaced free of charge to you or the purchase price will be refunded, depending on our choice.

GB

GB

Bibi & Tina[®]



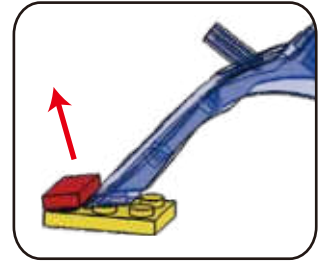
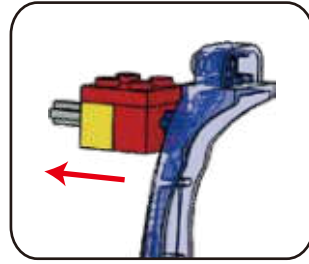
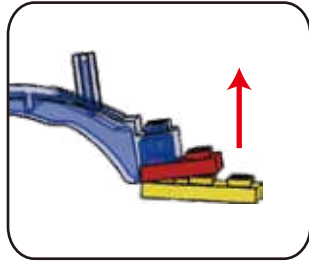
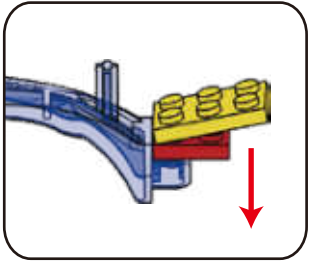

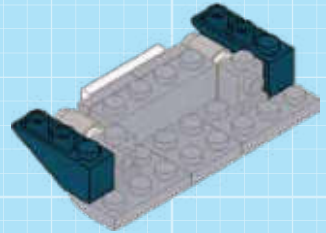
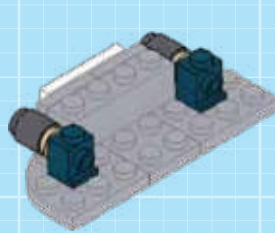
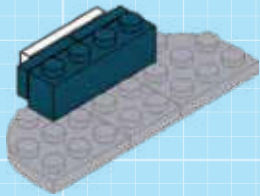
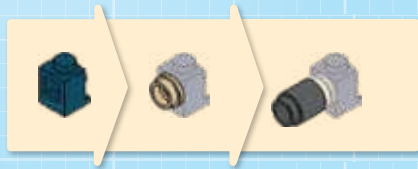
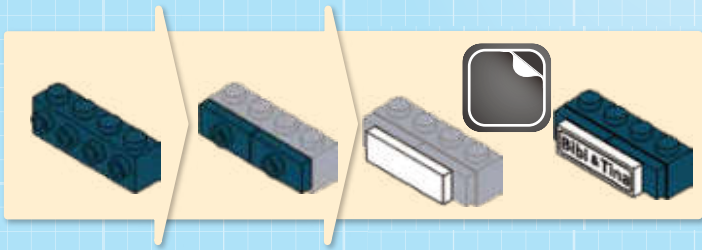
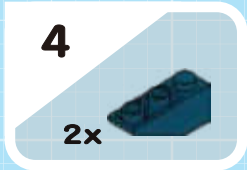
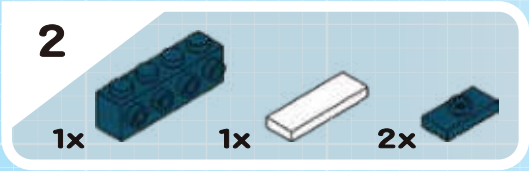
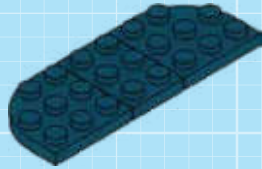
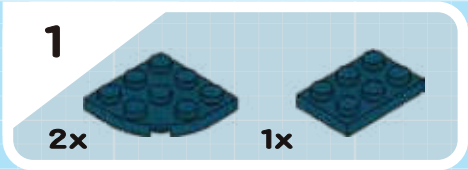
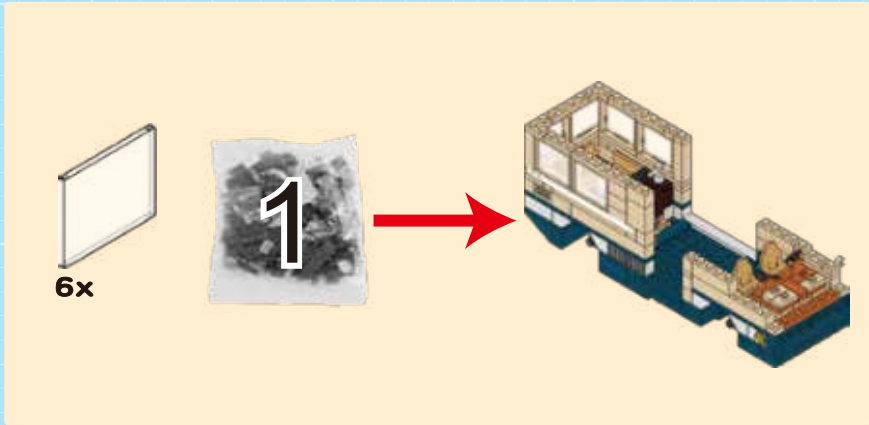

5

2x

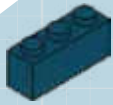

7

1x

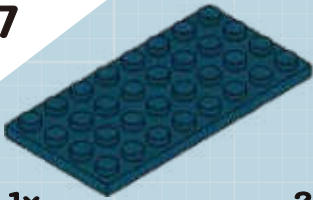

2x



2x



6

1x

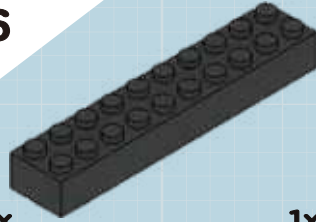

1x

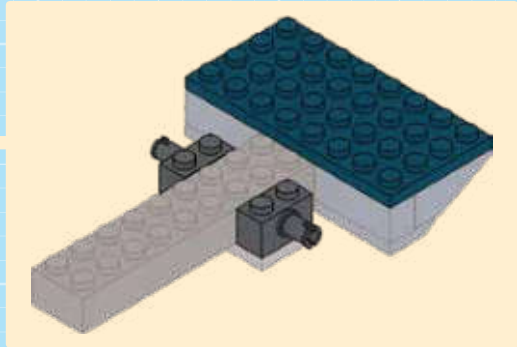
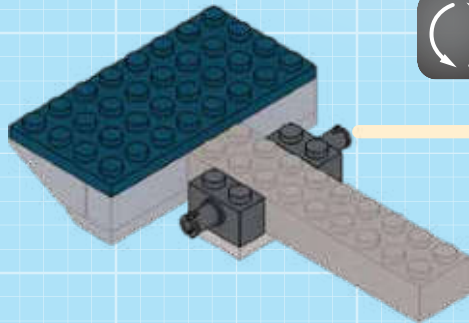
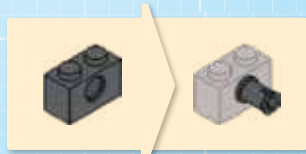
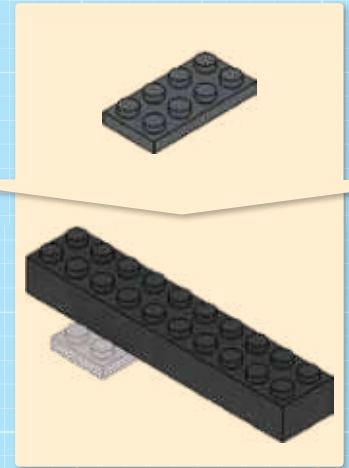
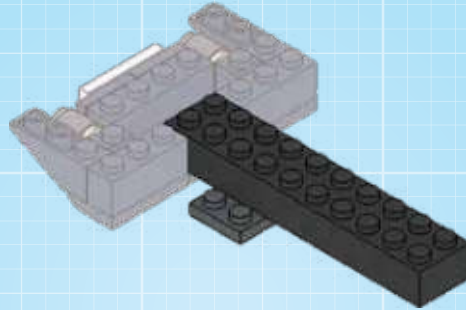
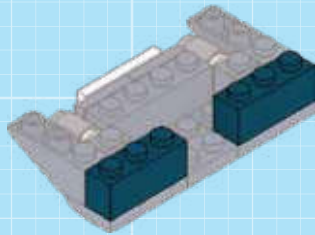

8

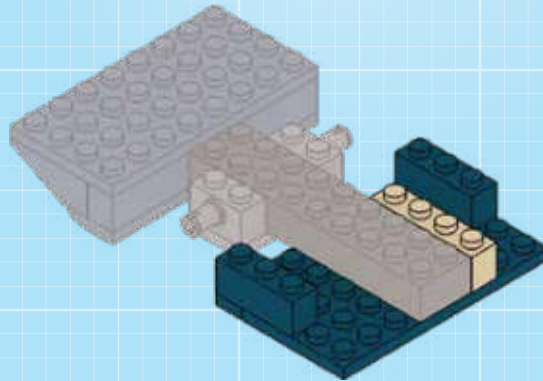
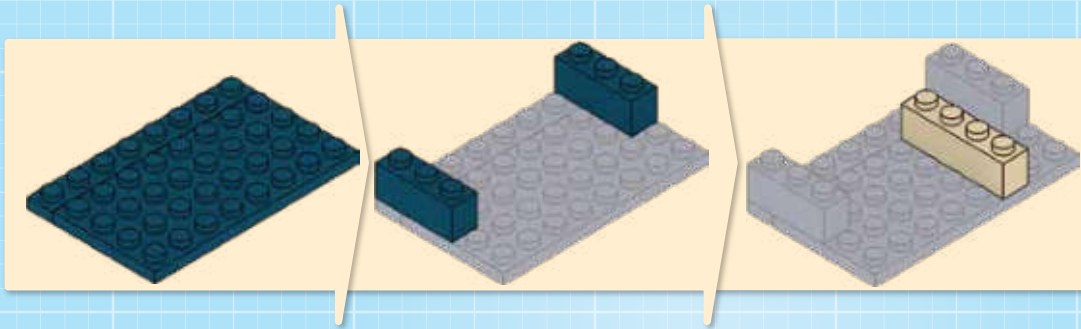
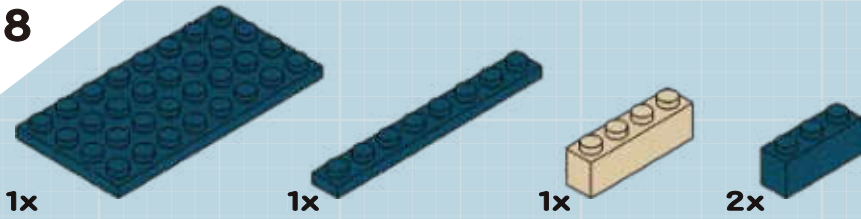

9

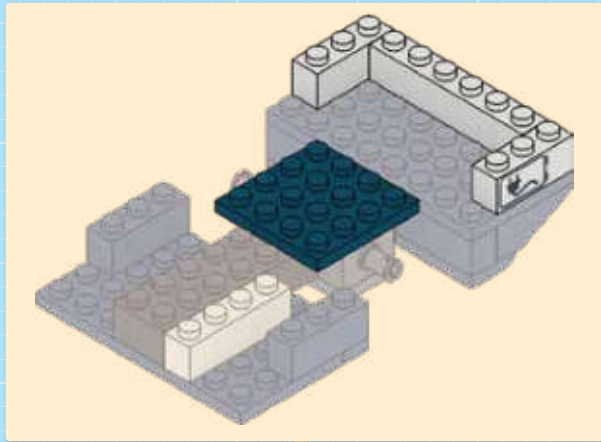
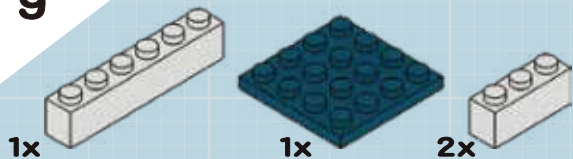

10

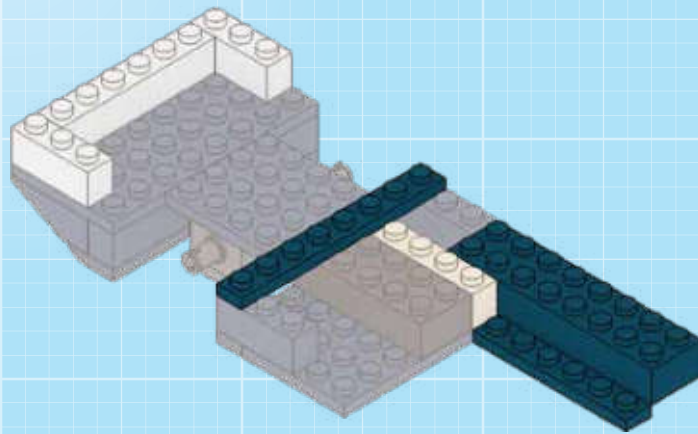
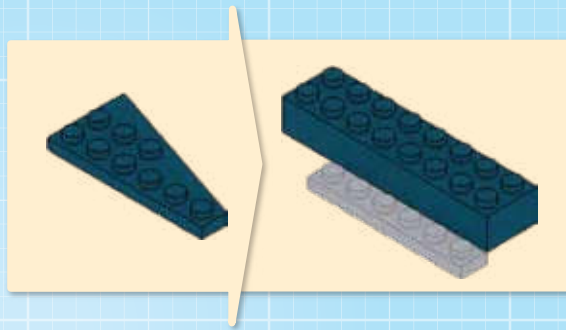
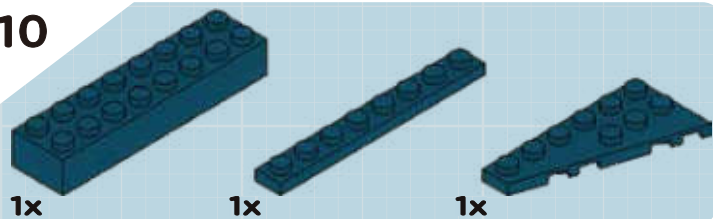

11

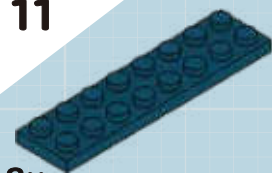

2x



1x



1x



1x



2x

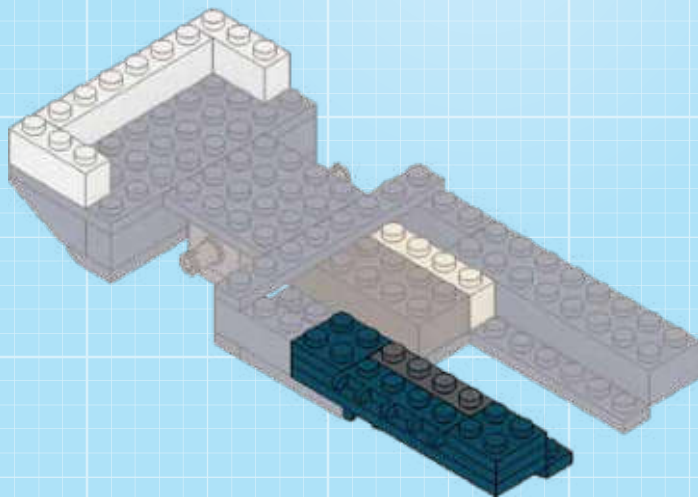
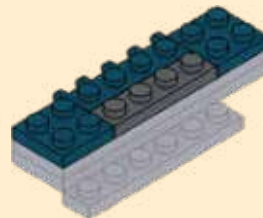
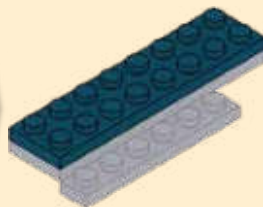
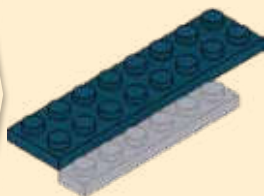

12

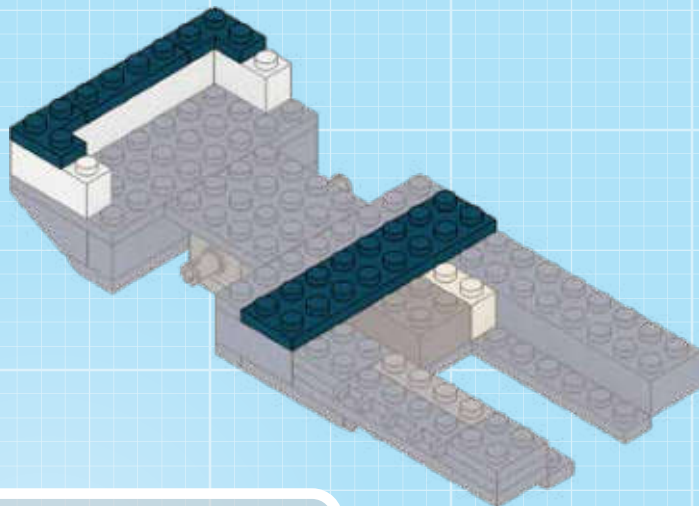
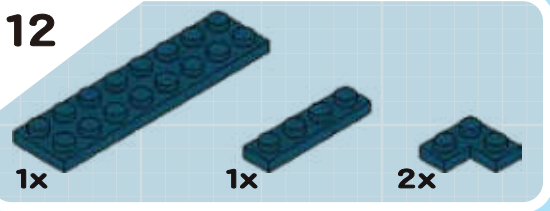

13

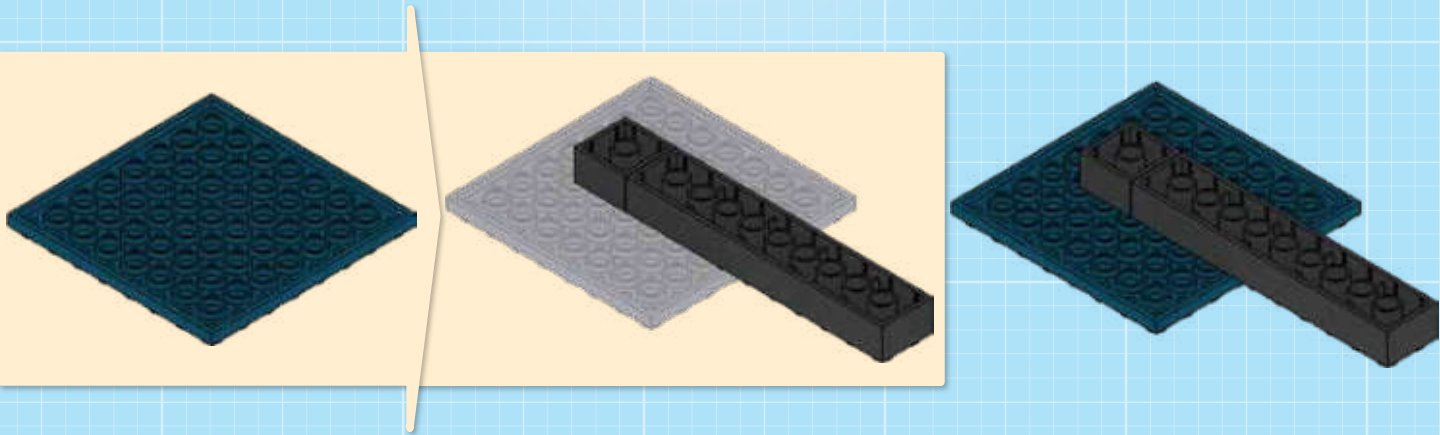
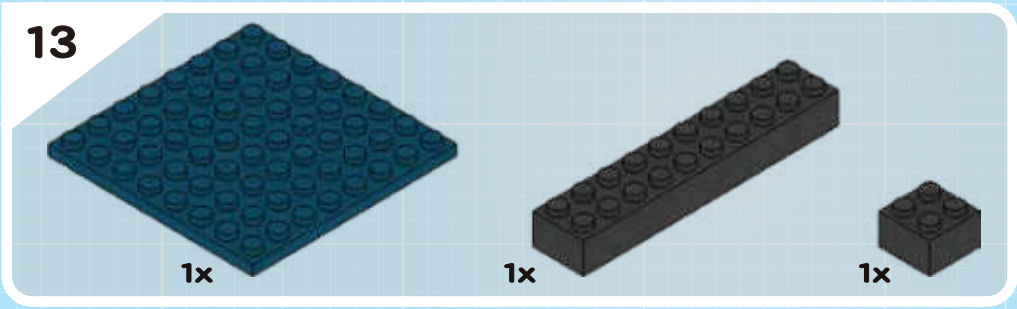

14

1x

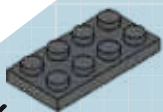

2x



2x

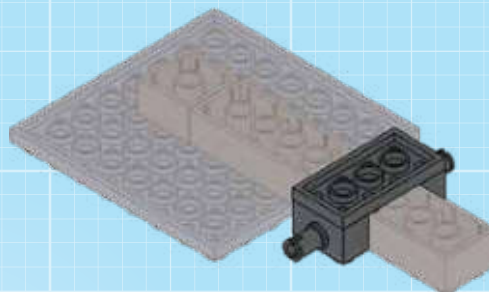
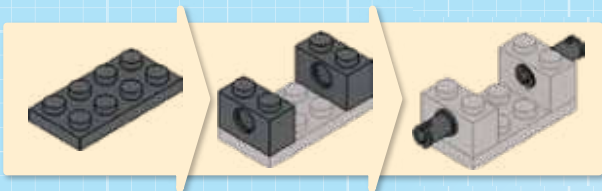

15



12

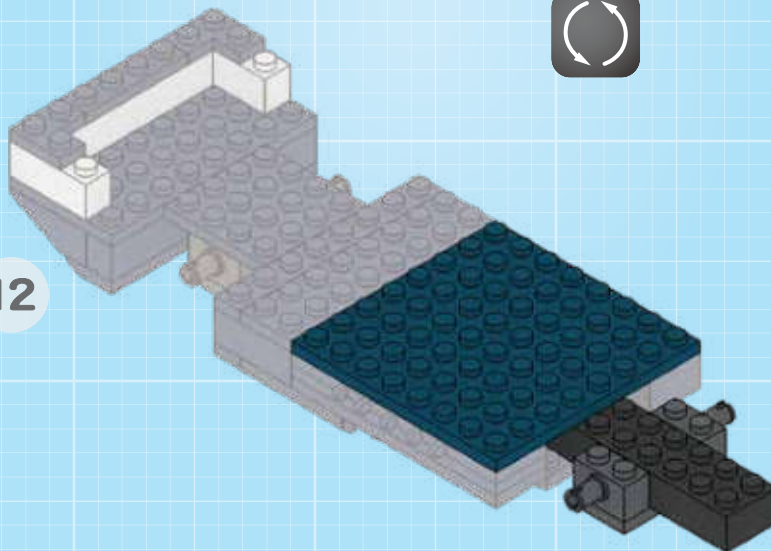

14

16

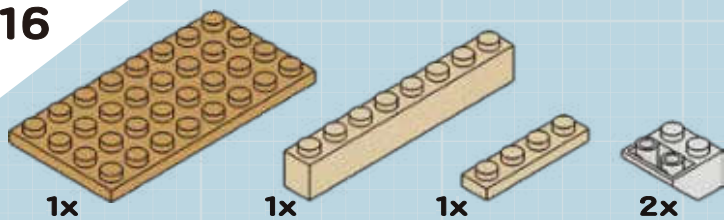

17

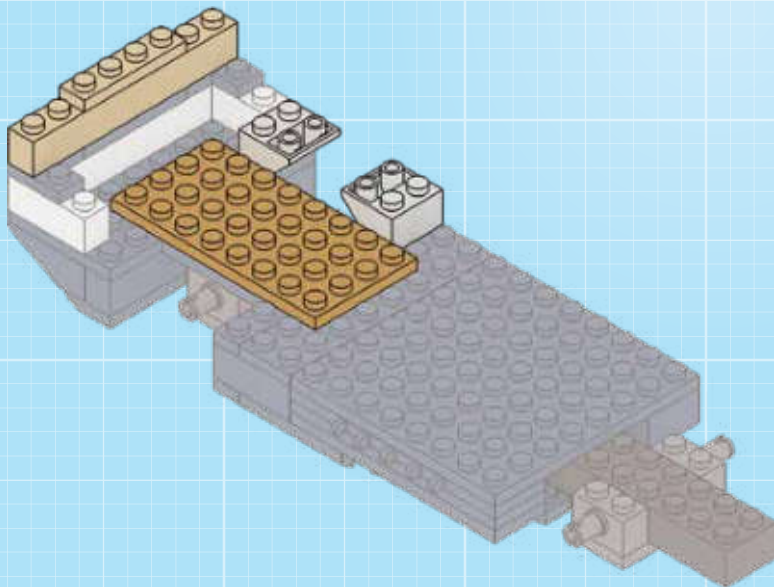
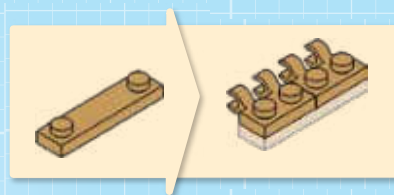
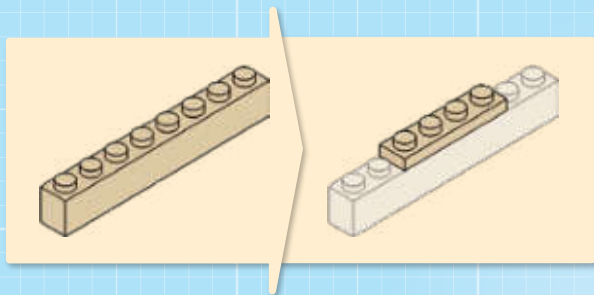

18

1x

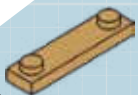

19

2x

1x

2x

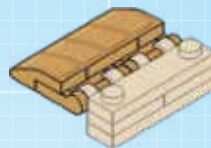
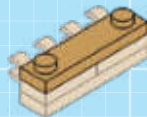

20

19

16

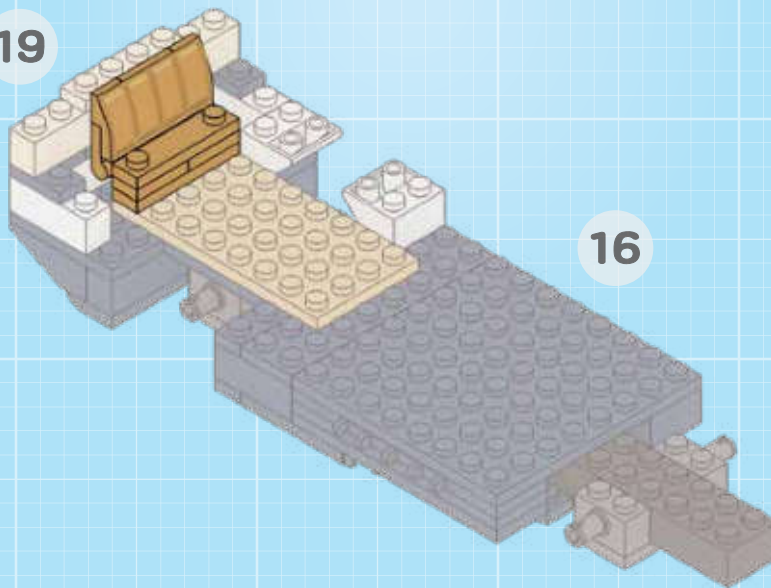

21

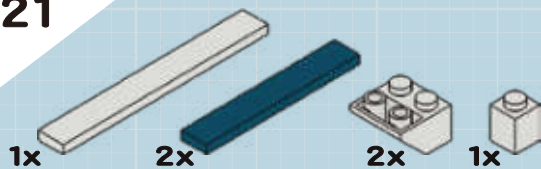

22

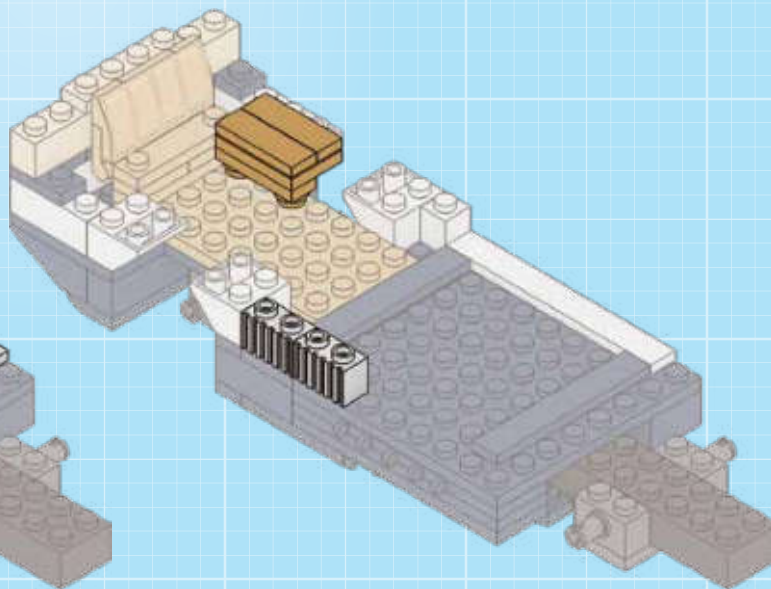
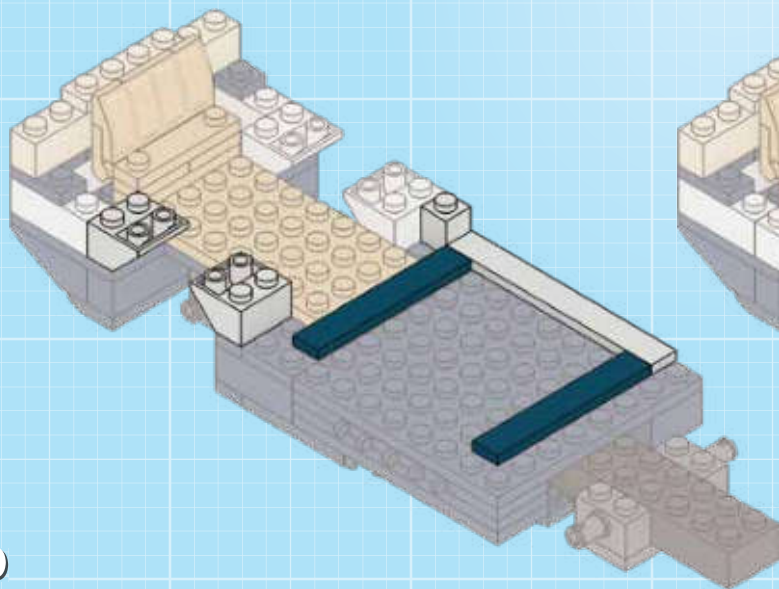
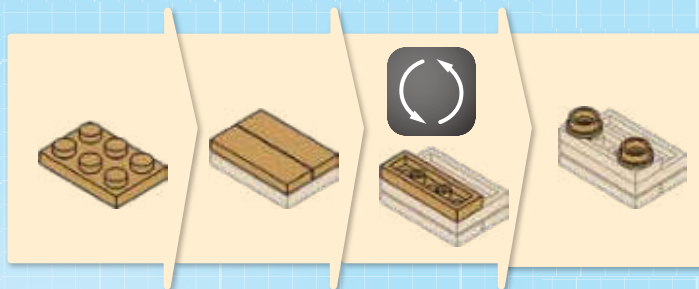
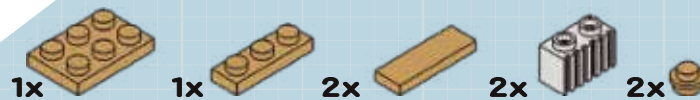

23

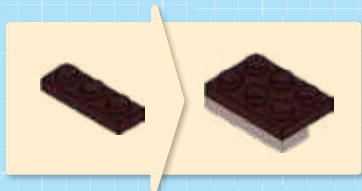

24

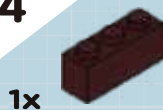

25

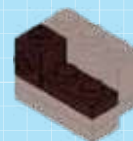

26

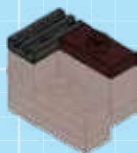

27



28

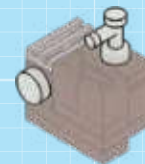

29

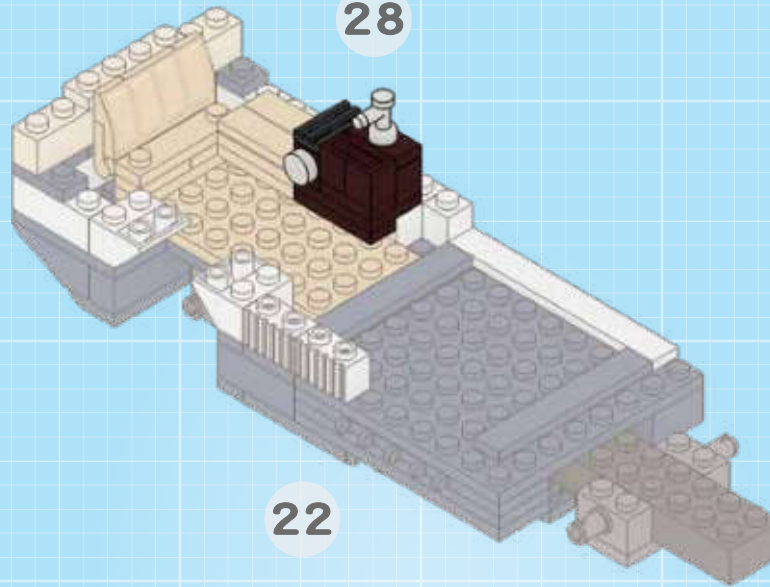

30

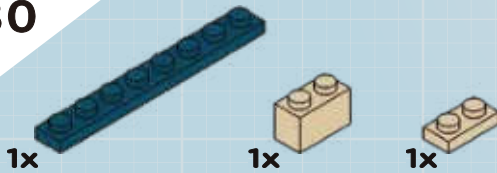

31

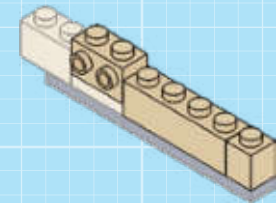
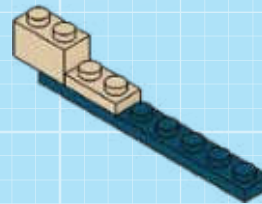
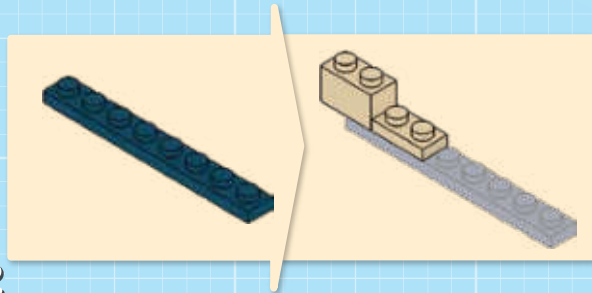
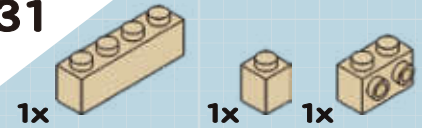

32

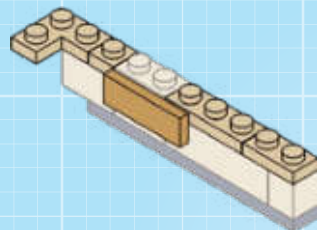
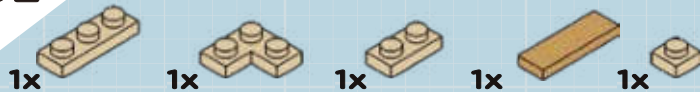

33

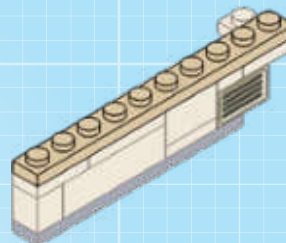
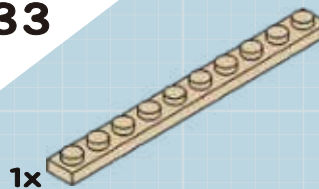

34



29

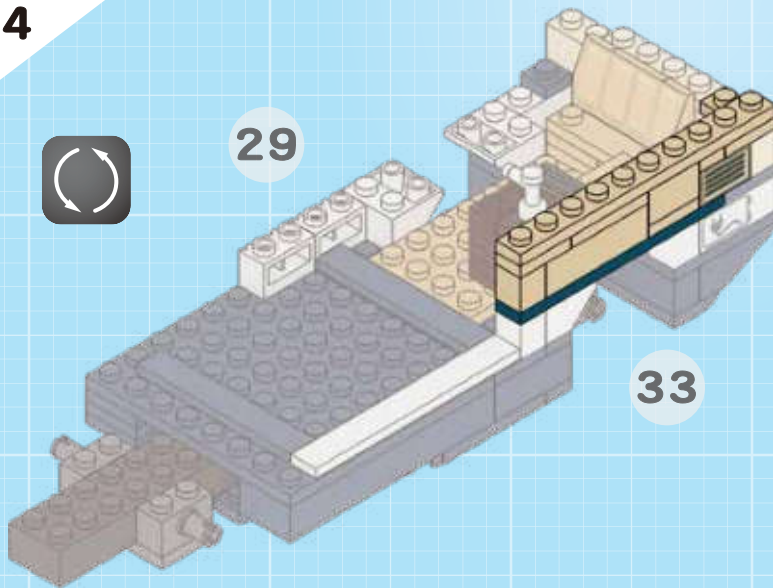

33

35

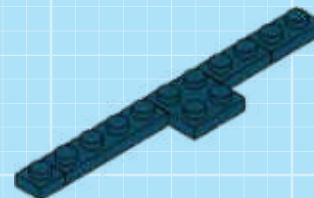

36

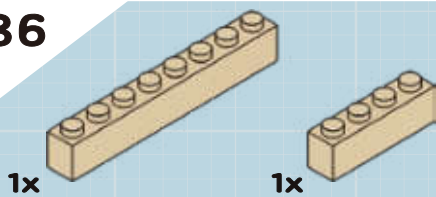

37

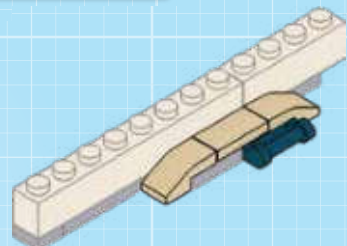
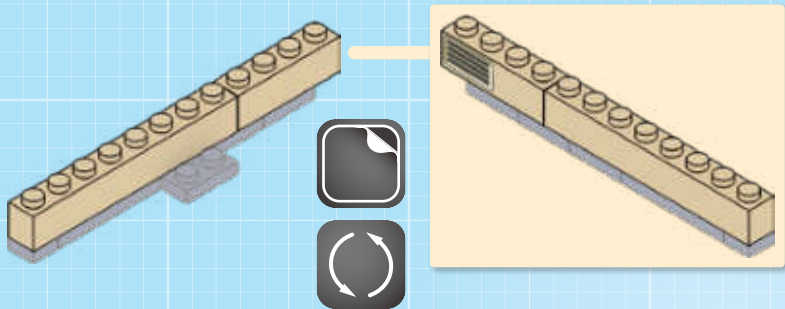
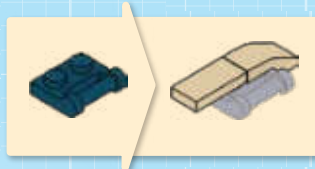

38

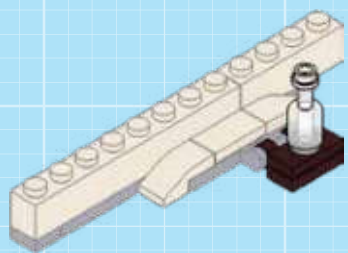
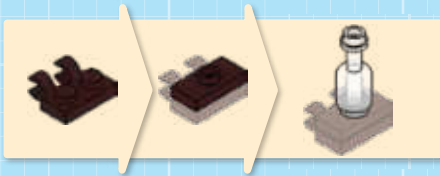
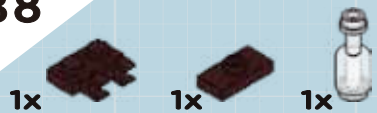

39

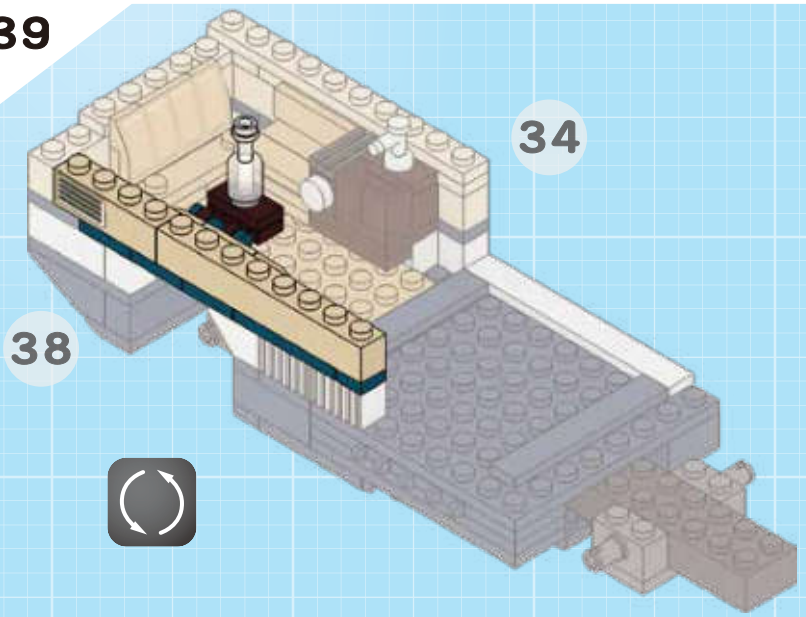

40

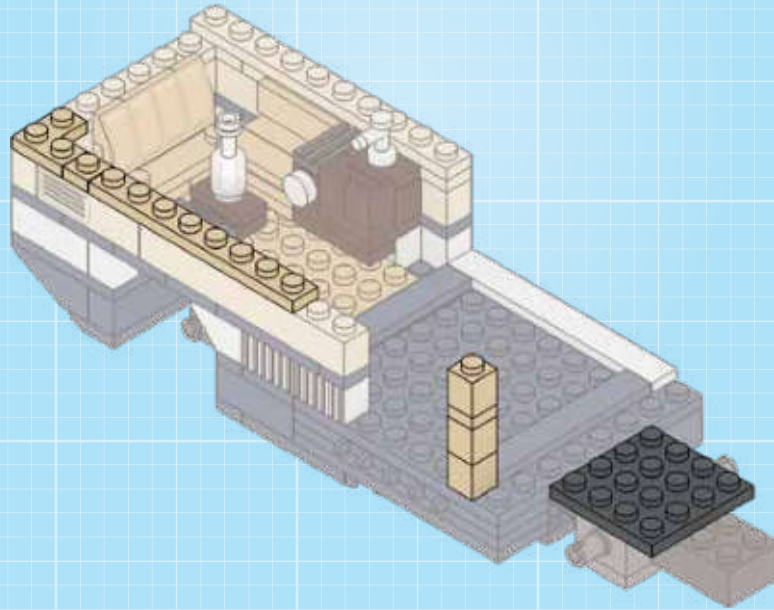
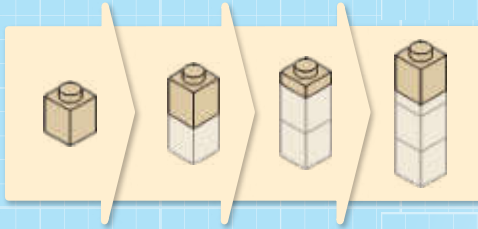
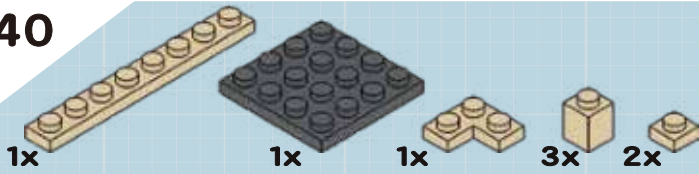

41

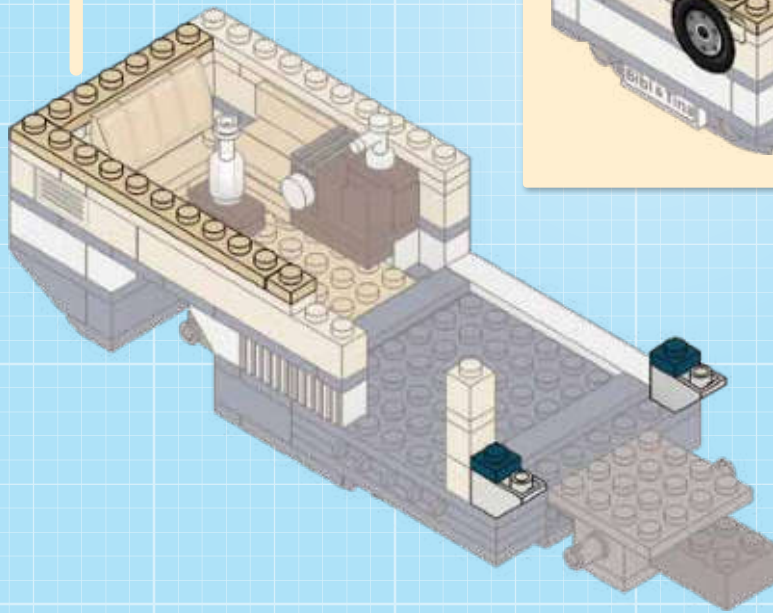
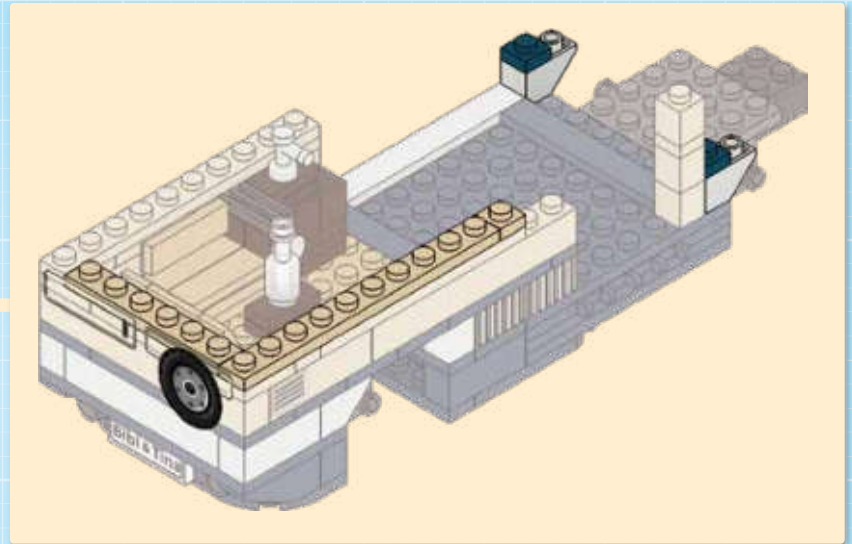
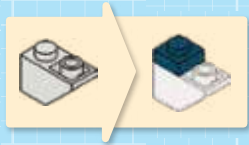
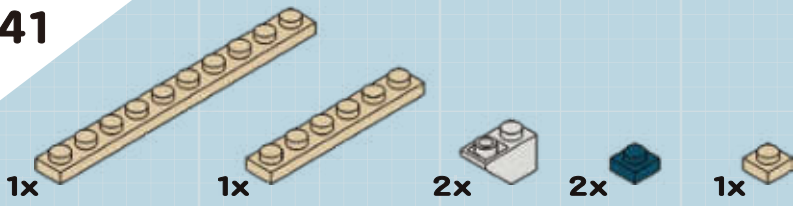

42

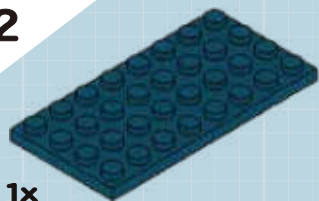

1x

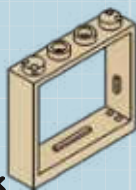

2x

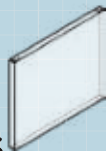

2x

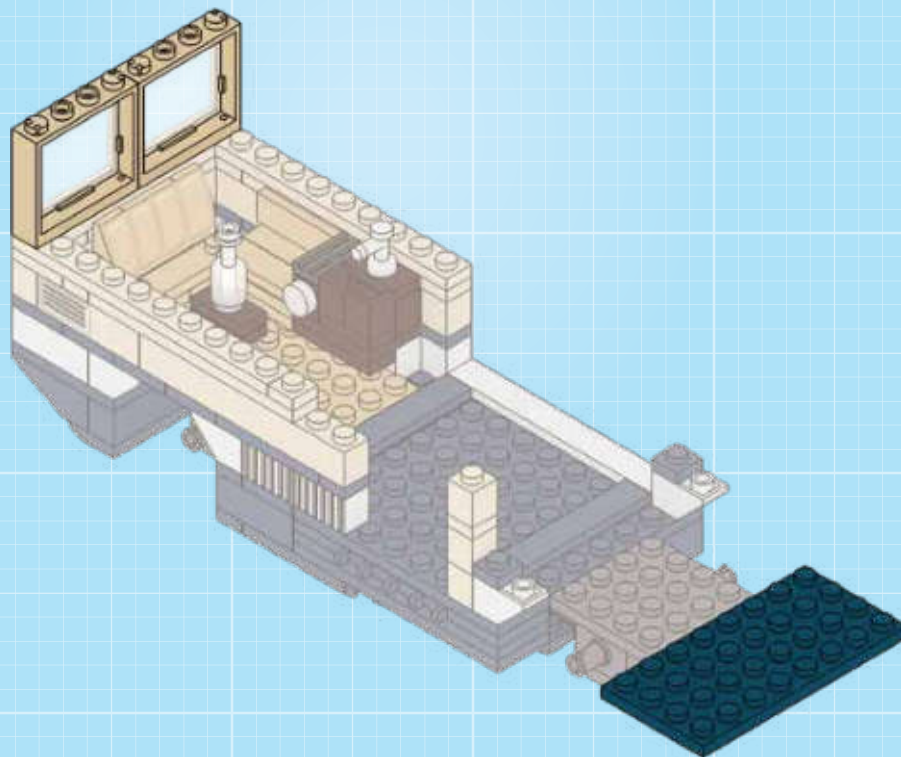
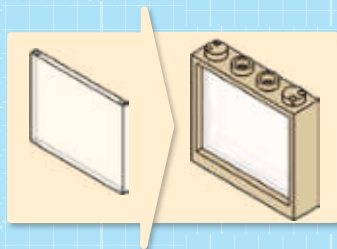

43

1x

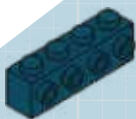

1x



4x

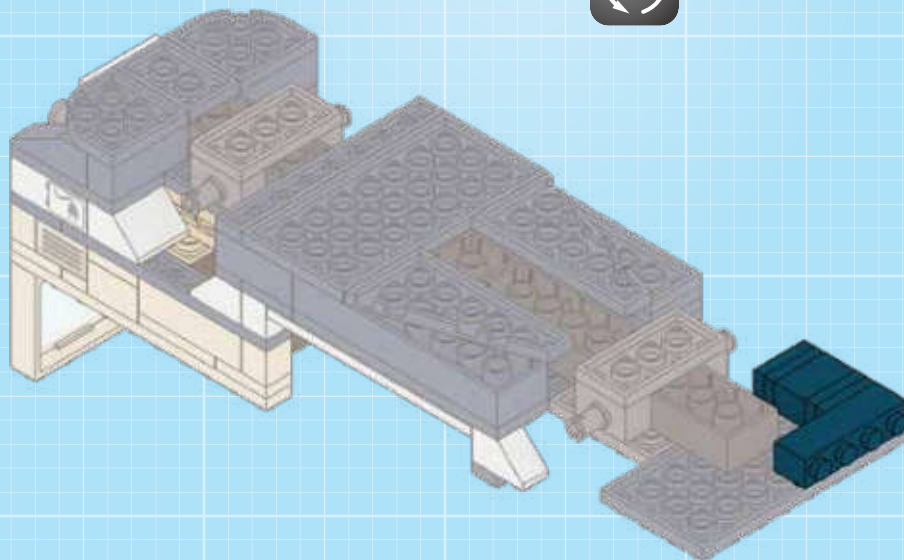
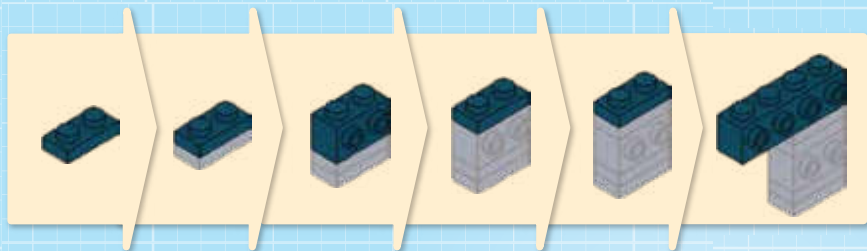

44

1x

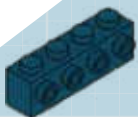

1x



4x

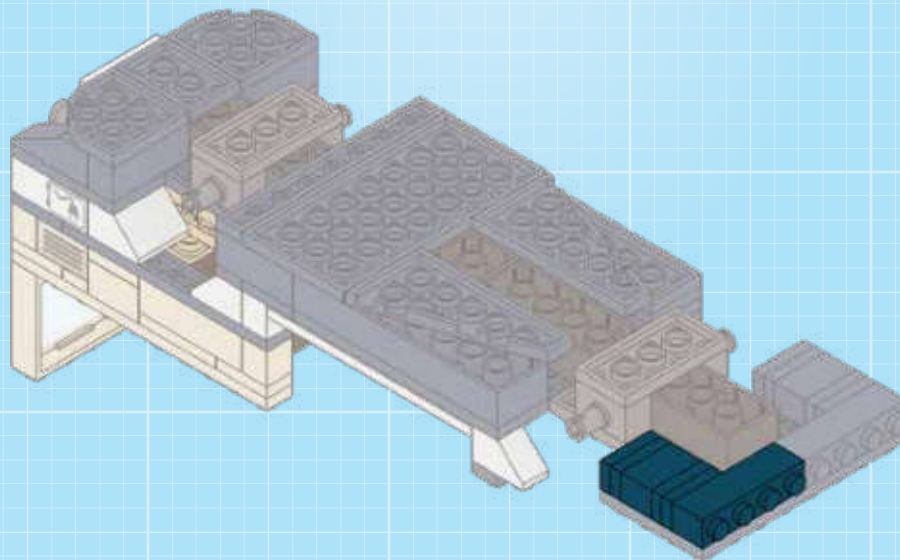
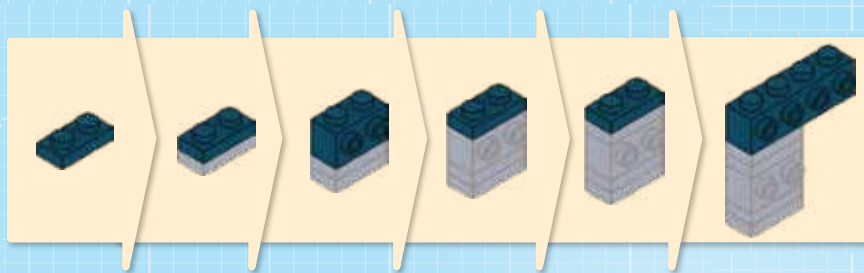

45

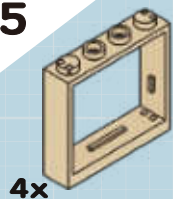

4x

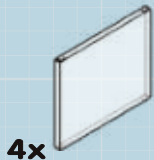

4x



1x

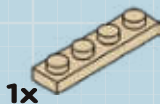

1x

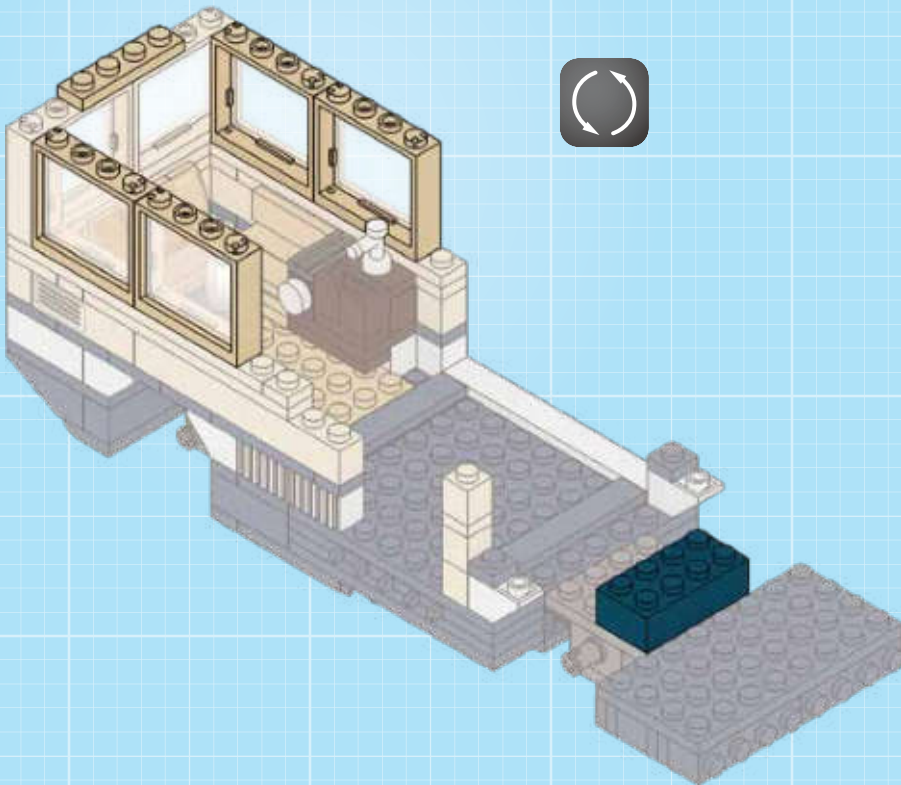
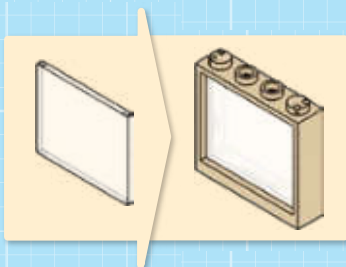

46



2x



2x



1x

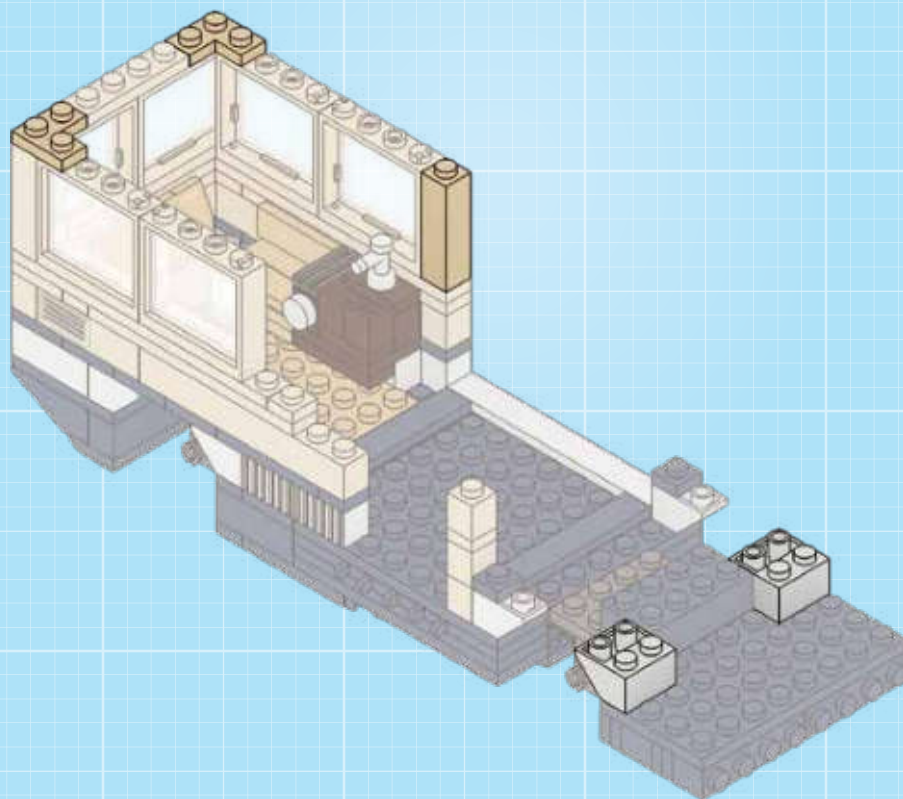

47

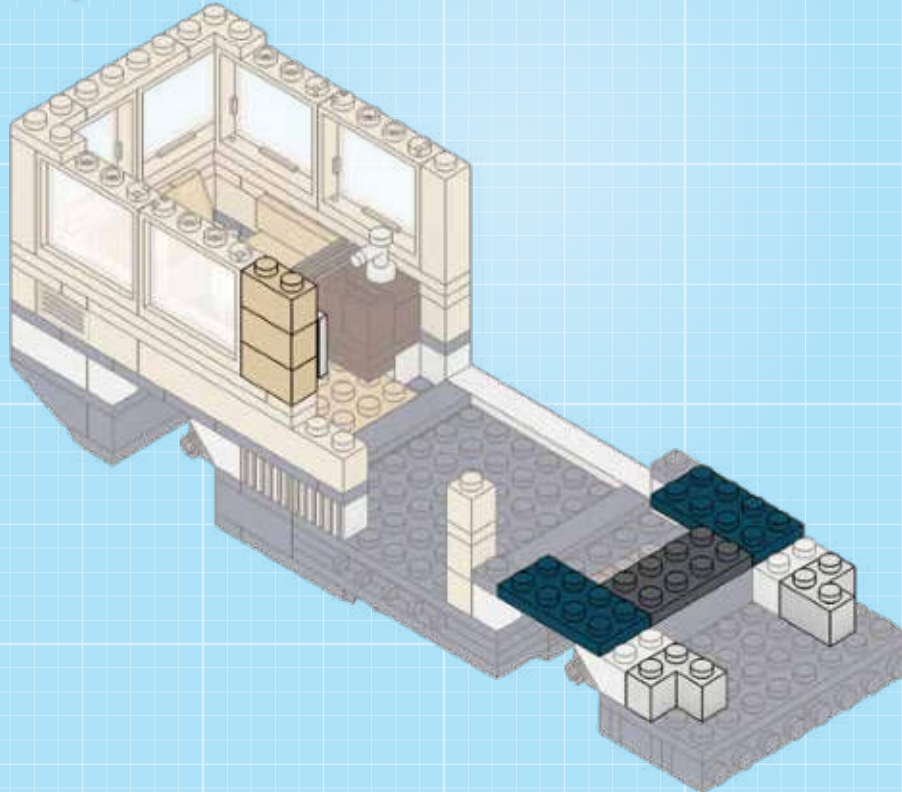
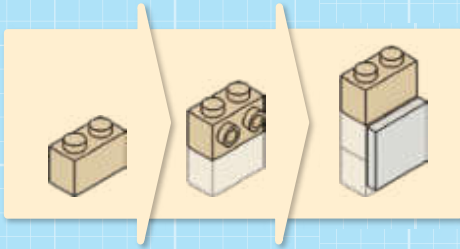

48

1x



1x



1x



2x



1x



2x

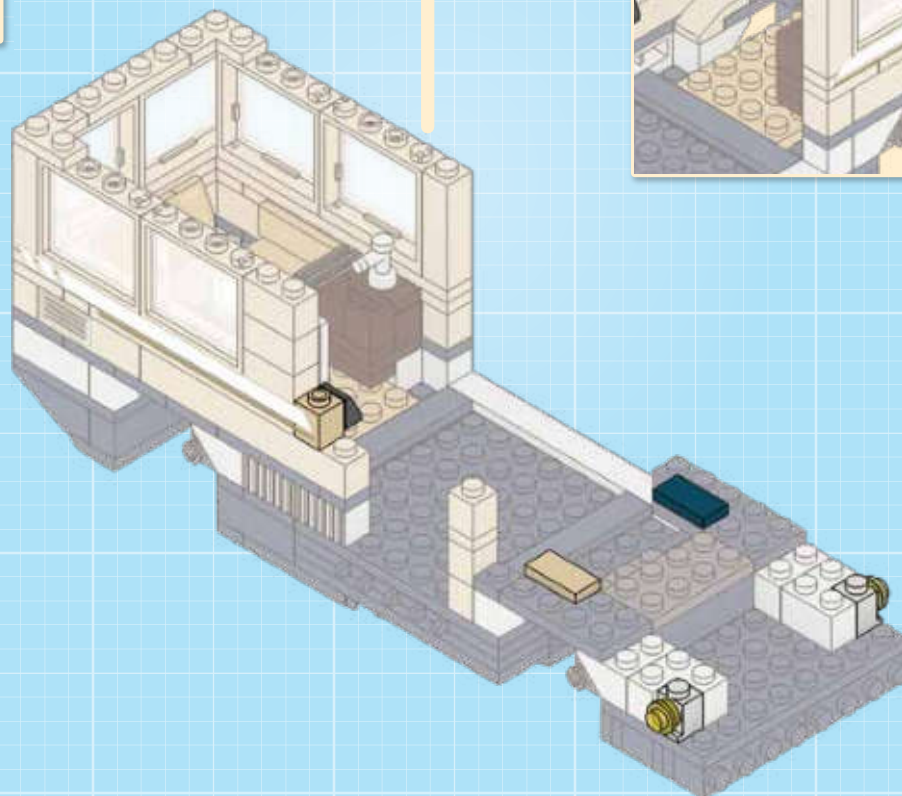
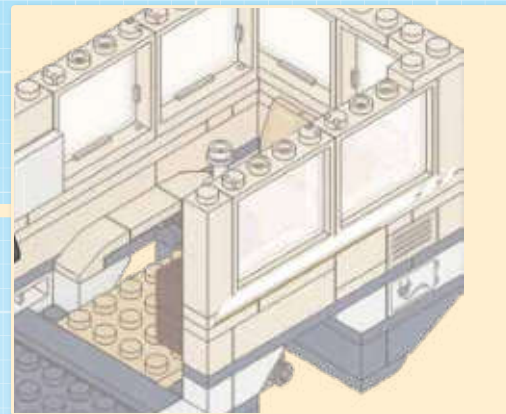

49

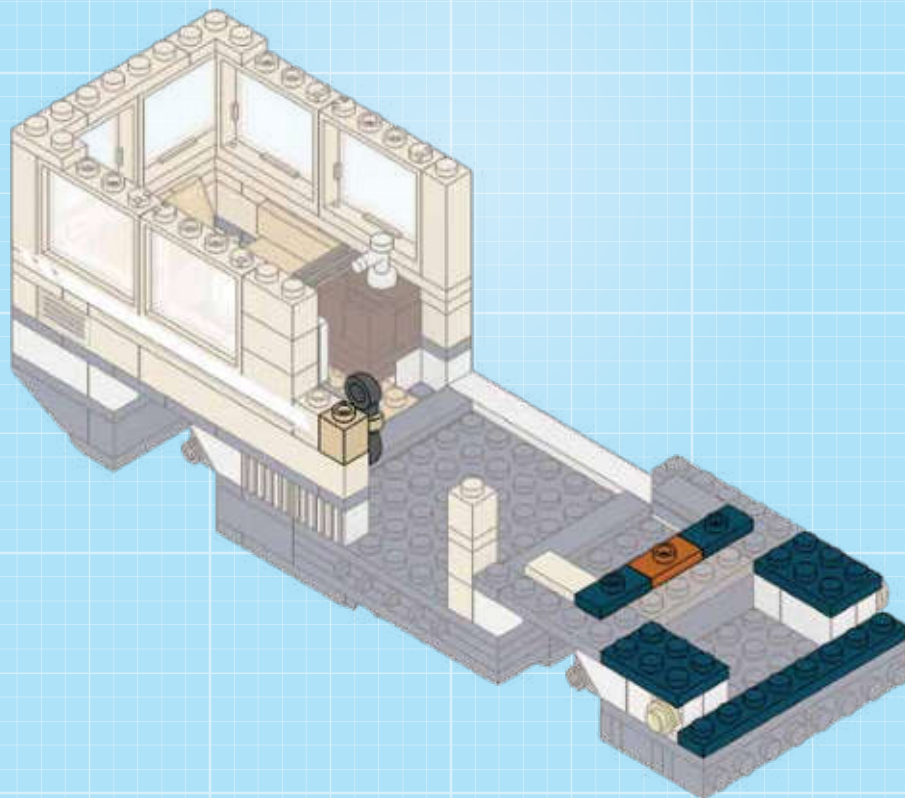
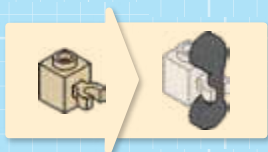
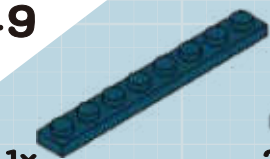

50

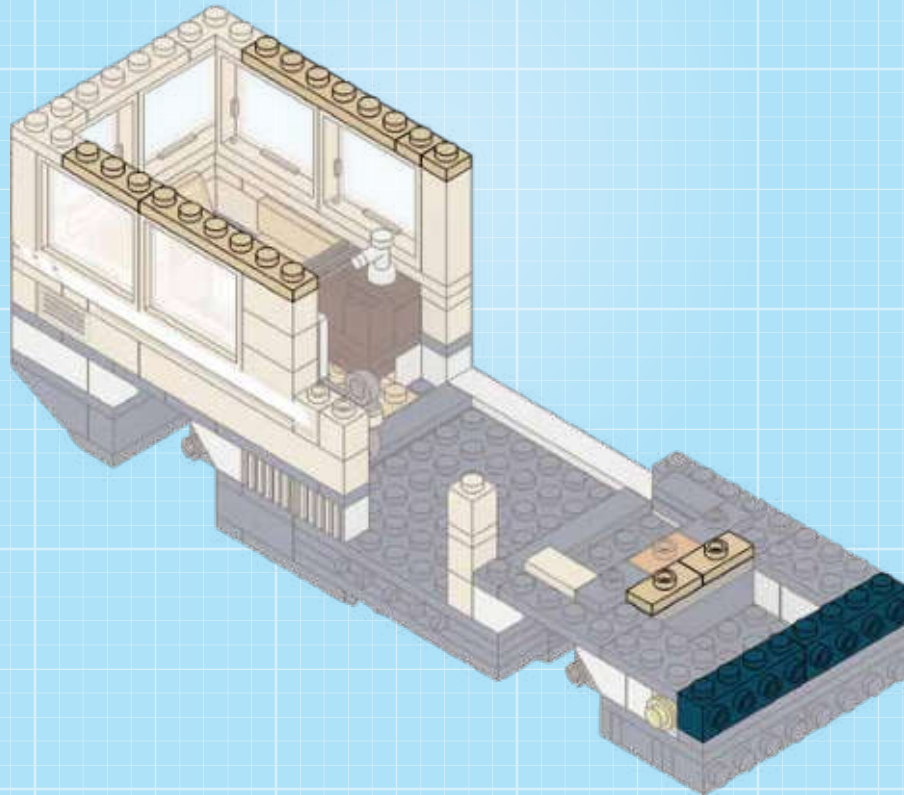
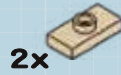
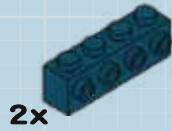
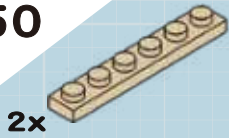

51

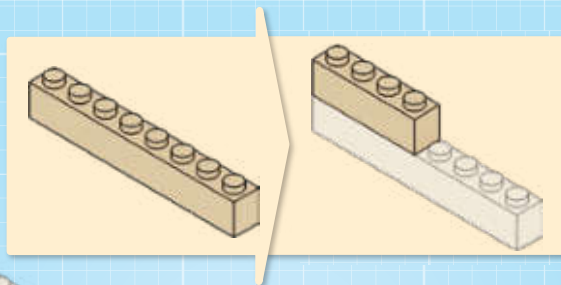
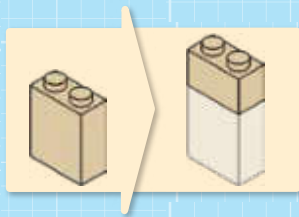
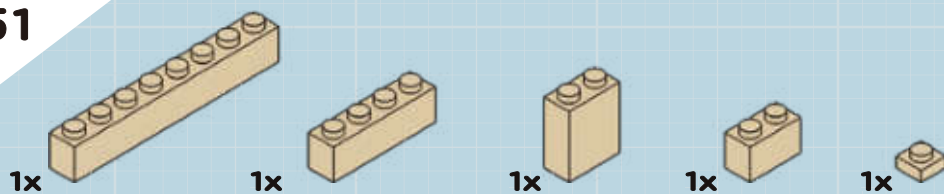

52



1x



1x



2x



1x



1x

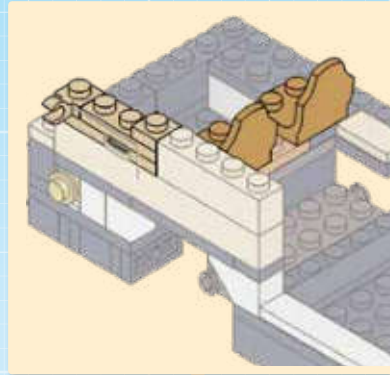
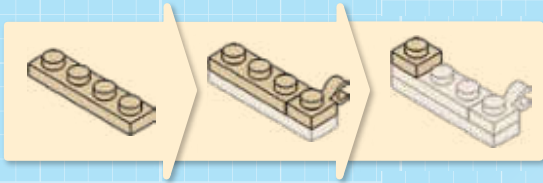

53



1x



4x



5x



1x

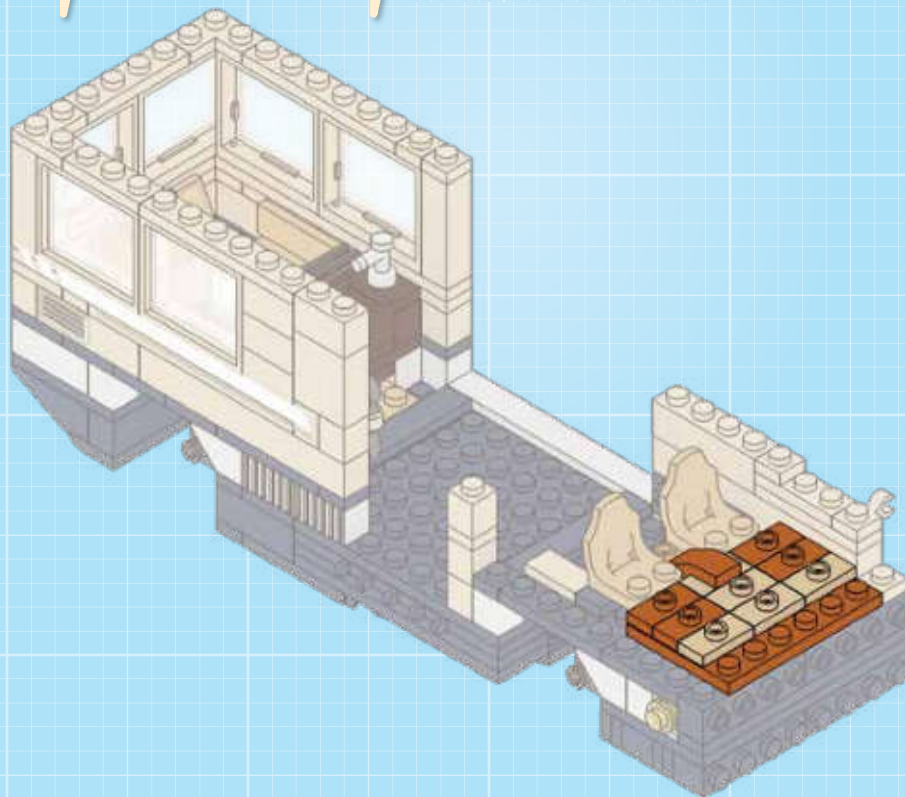
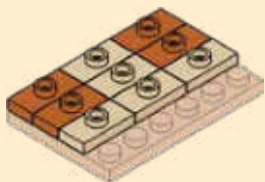

54



1x



1x



1x



1x



1x

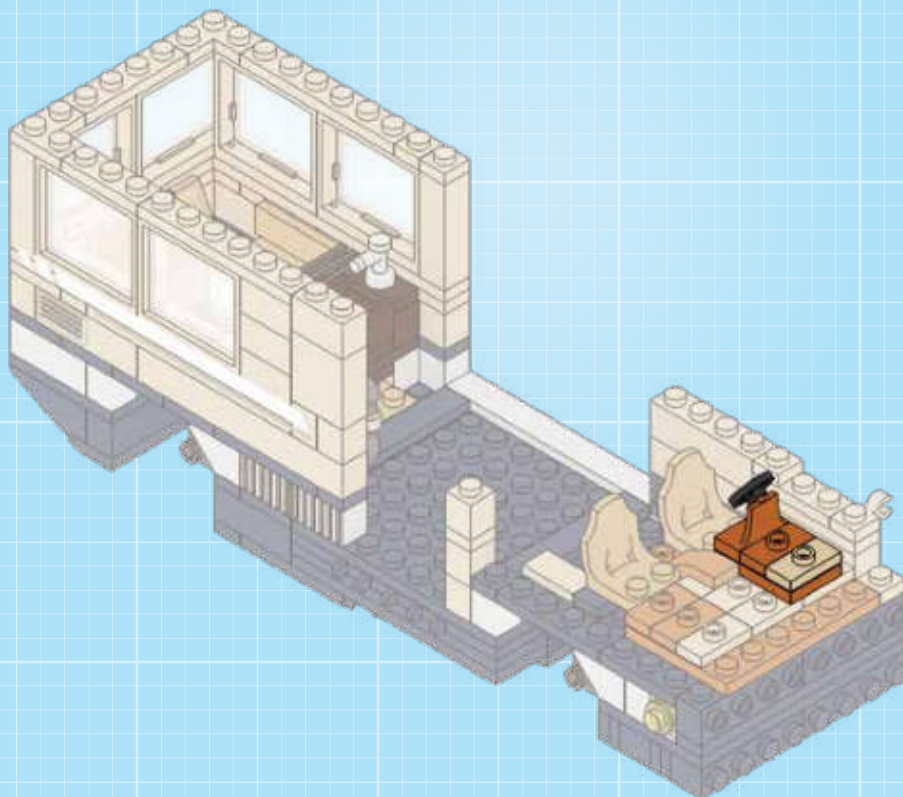
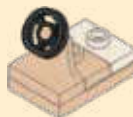

55

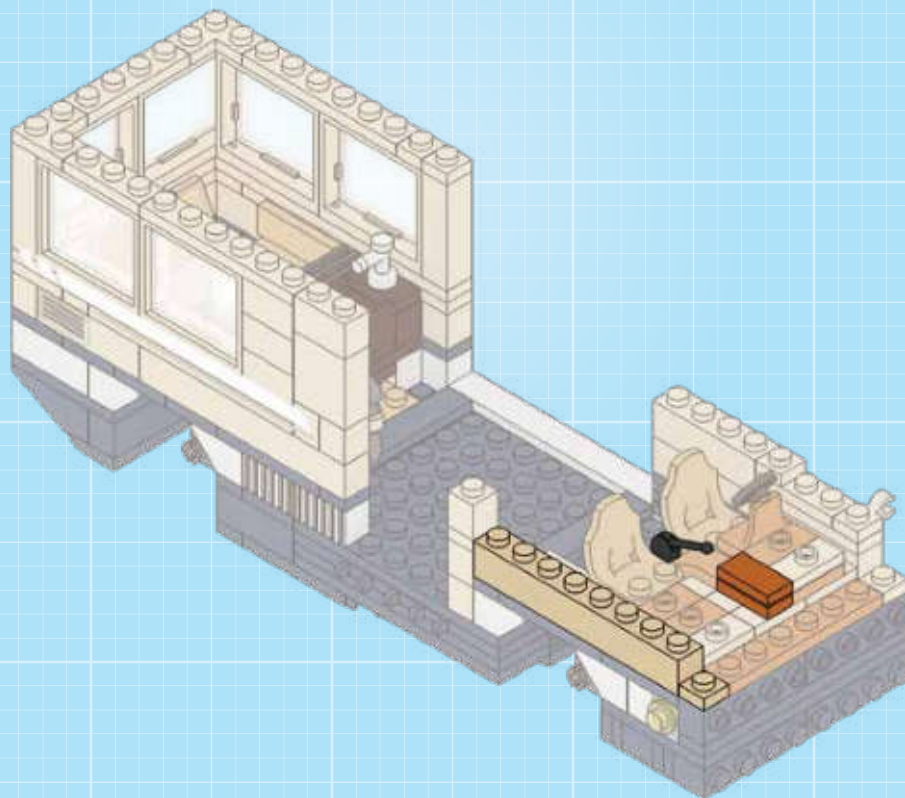
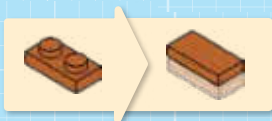
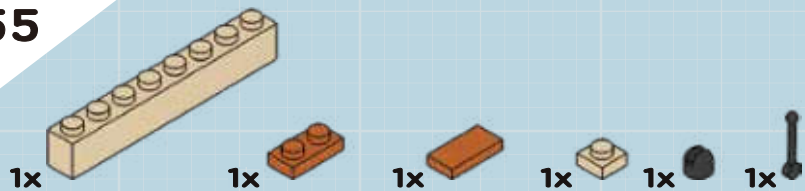

56

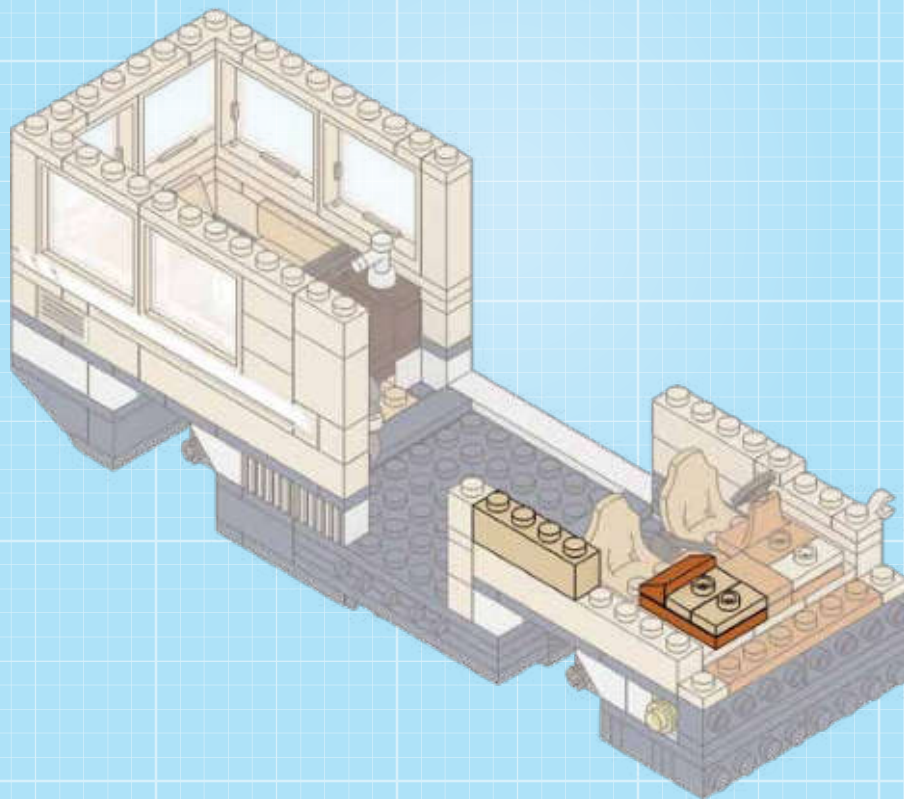
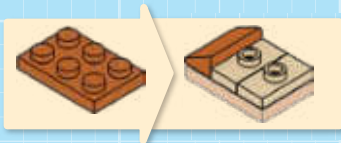
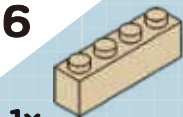

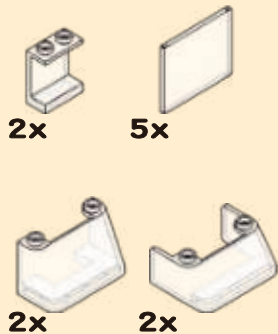

57

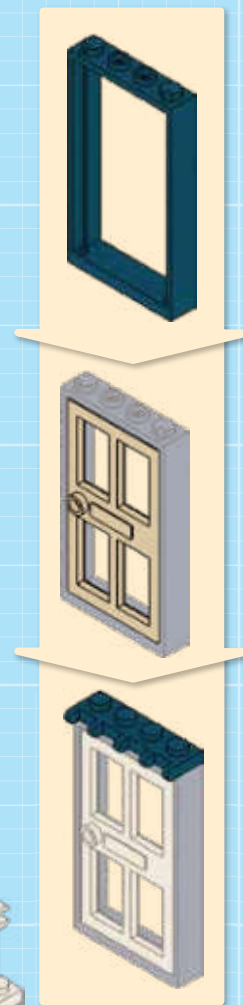
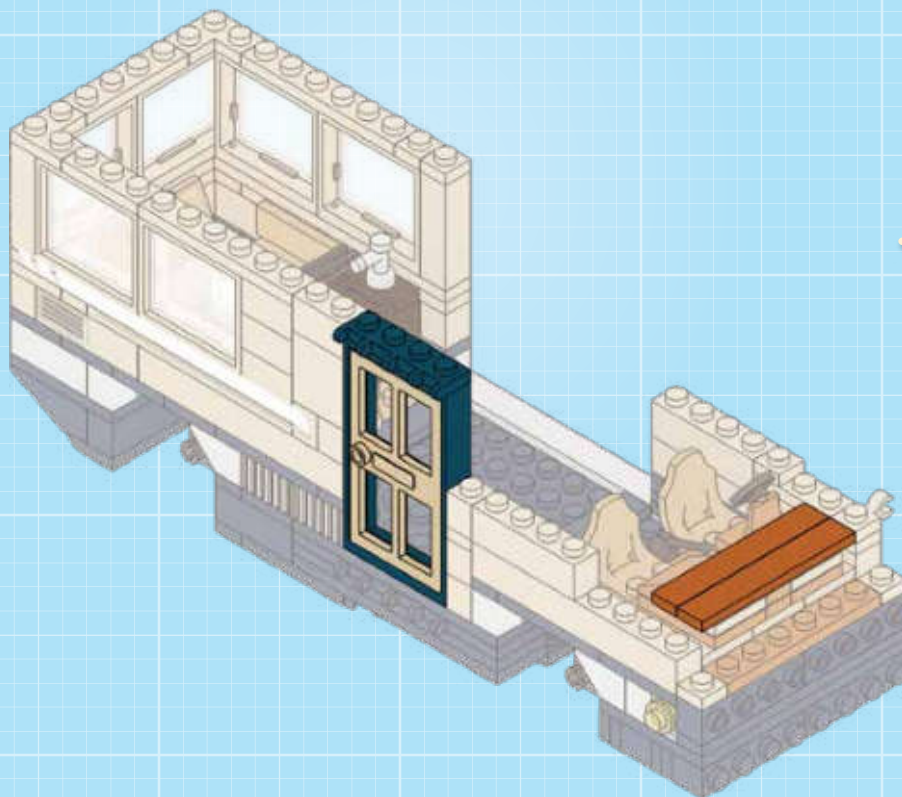
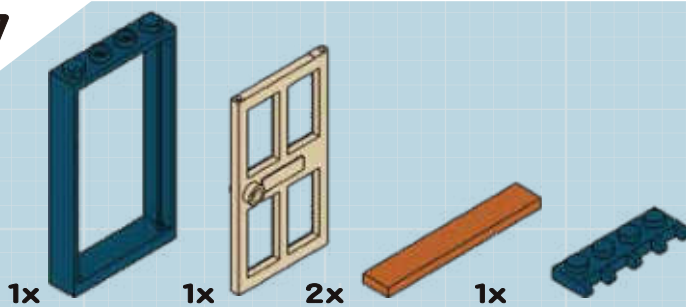

58

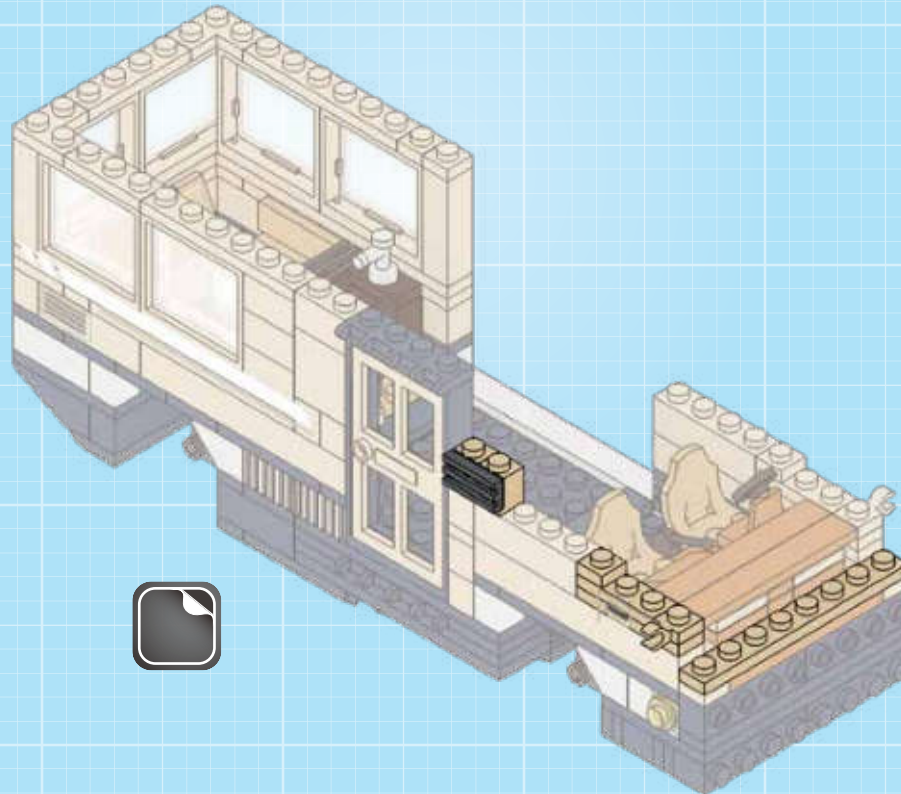
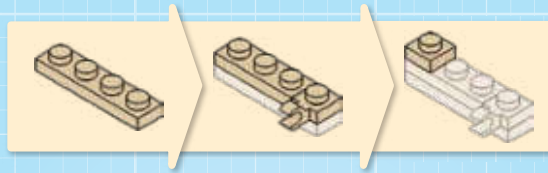
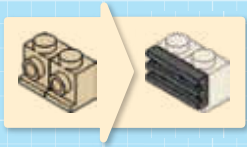
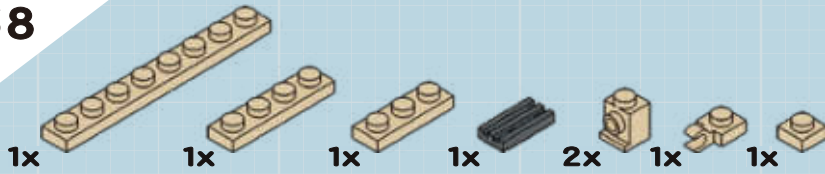

59

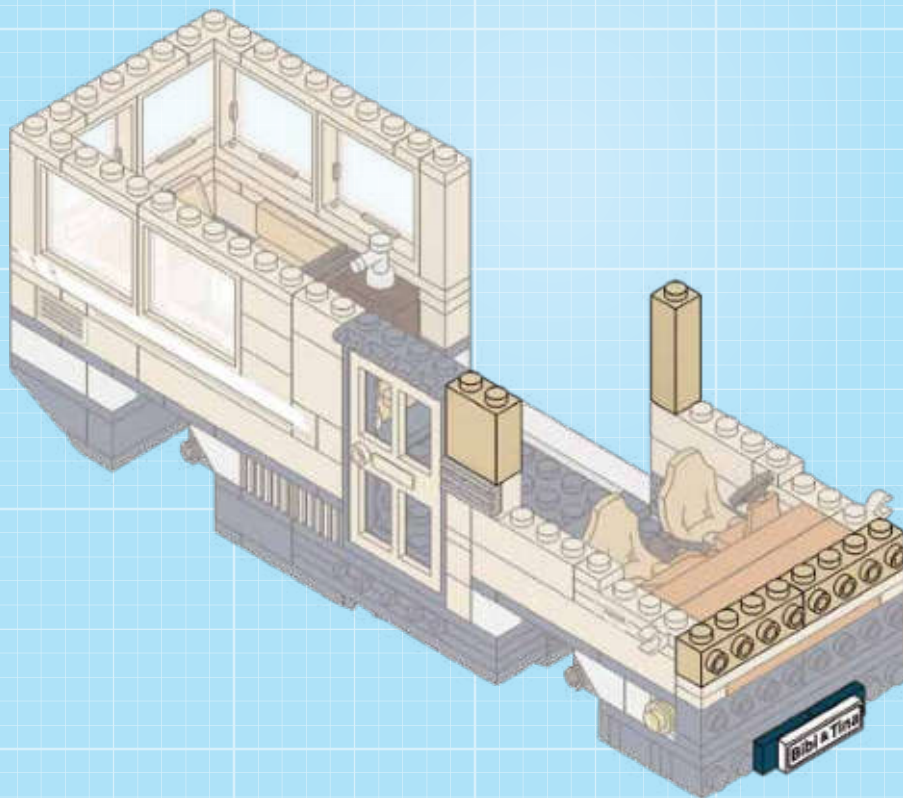
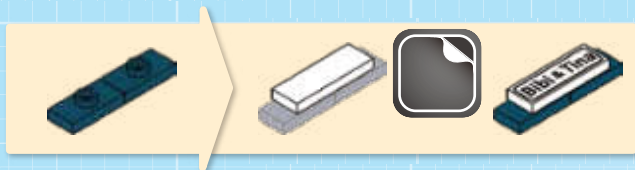
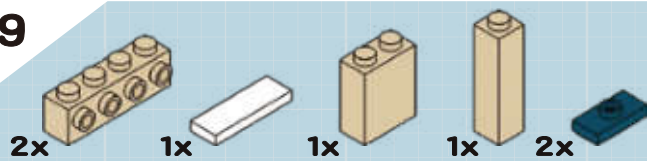

60

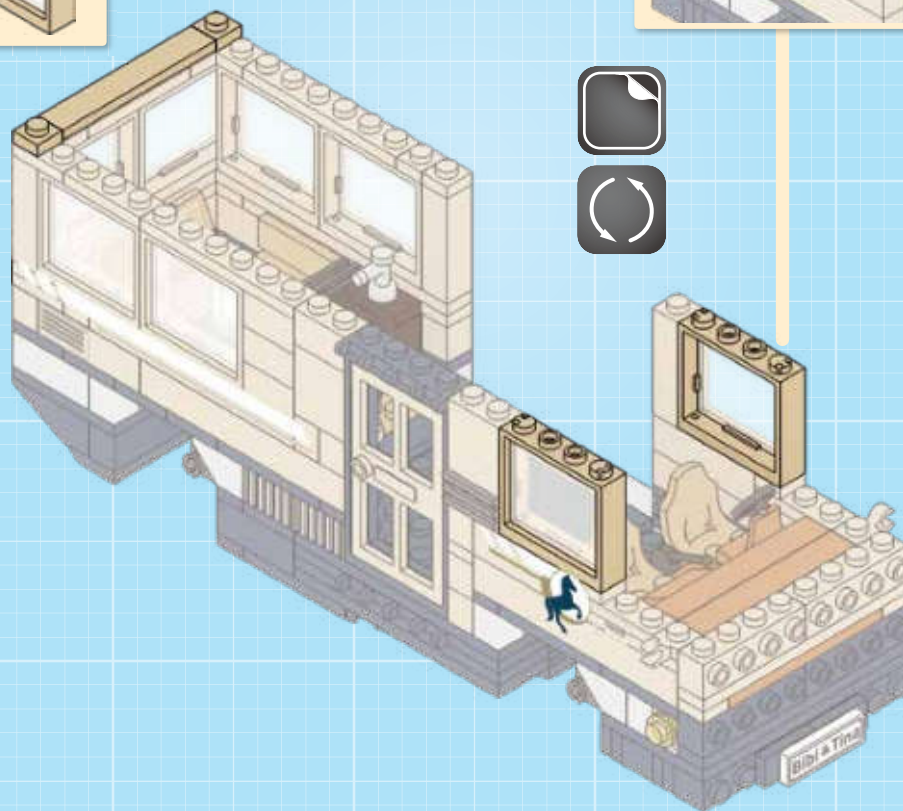
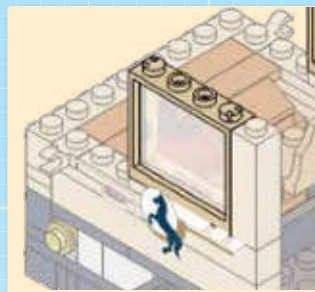
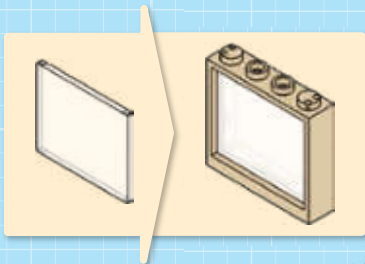
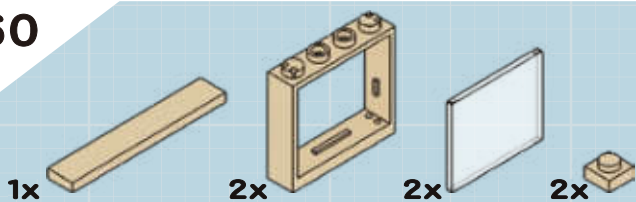

61

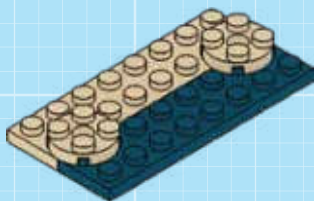
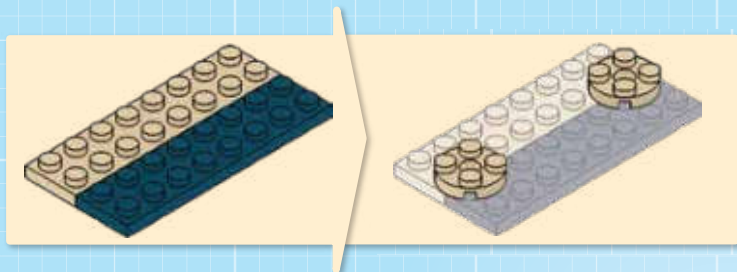
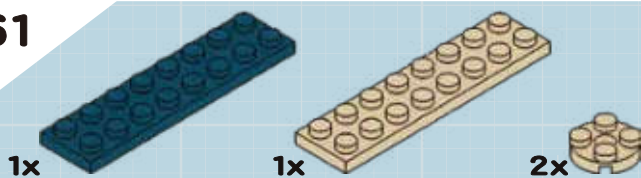

62

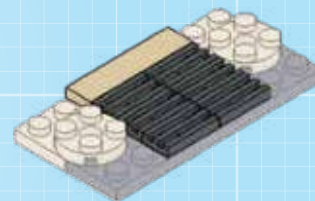
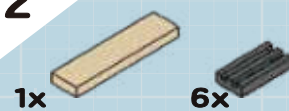

63

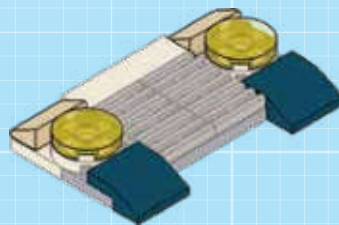
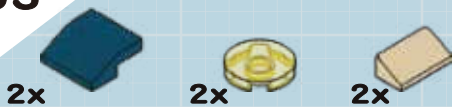

64

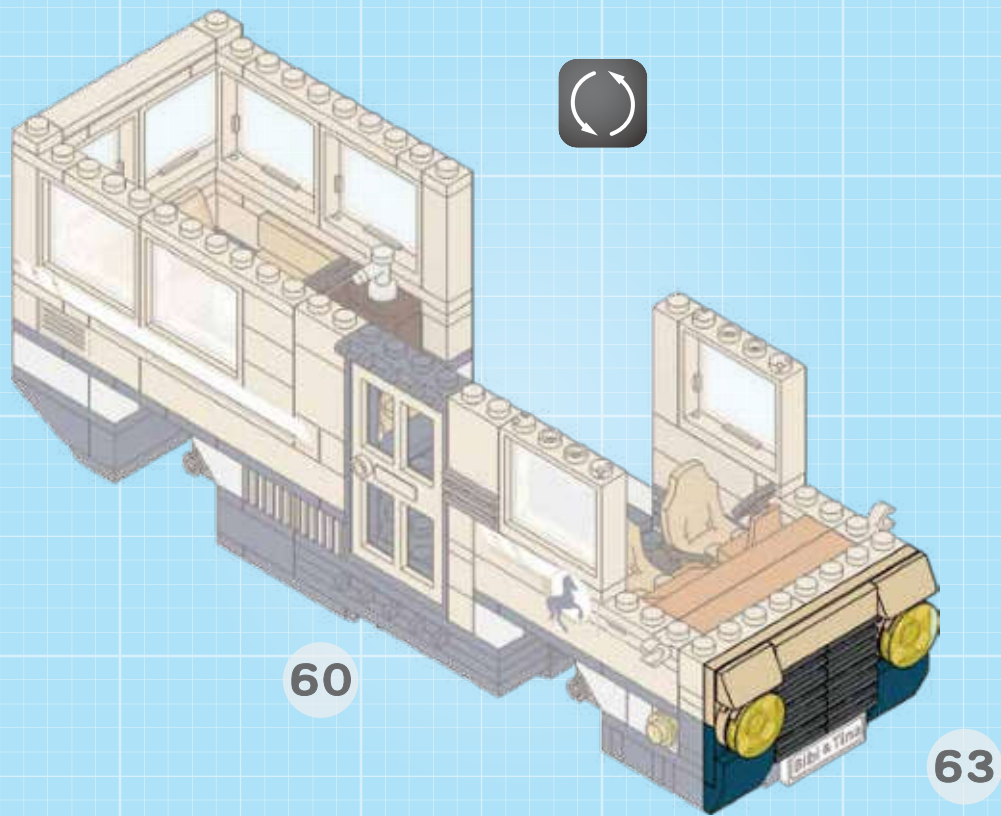

65

2x

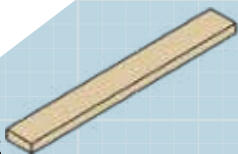

1x

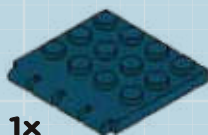

2x



2x



66

1x

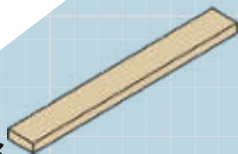

2x



2x

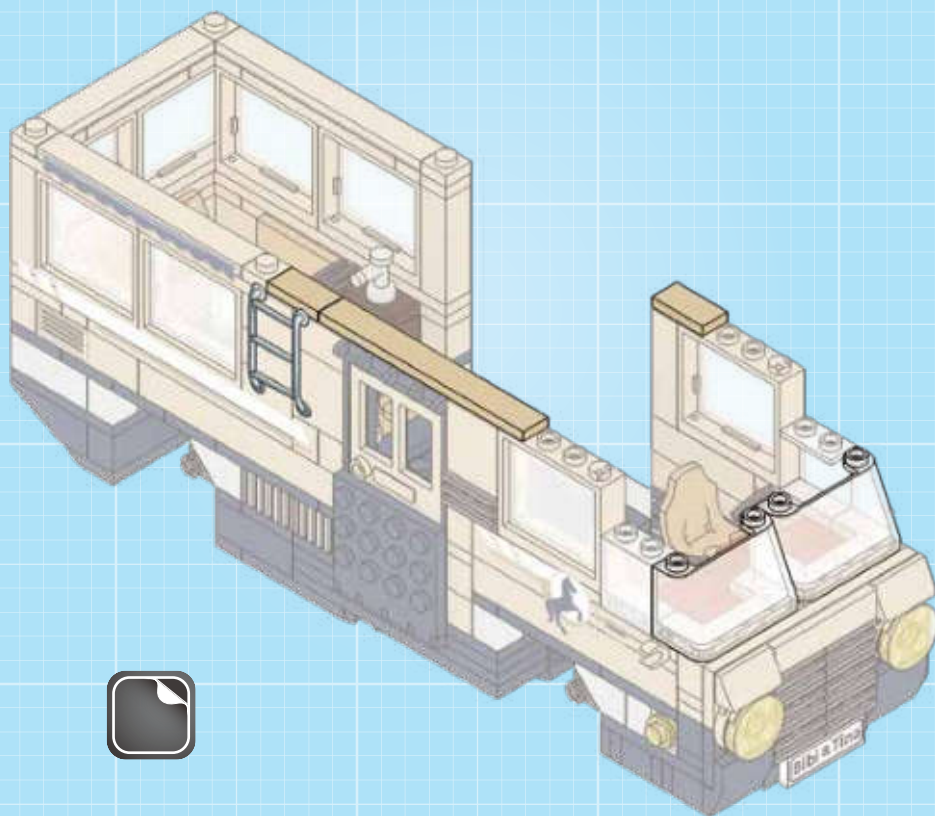

67

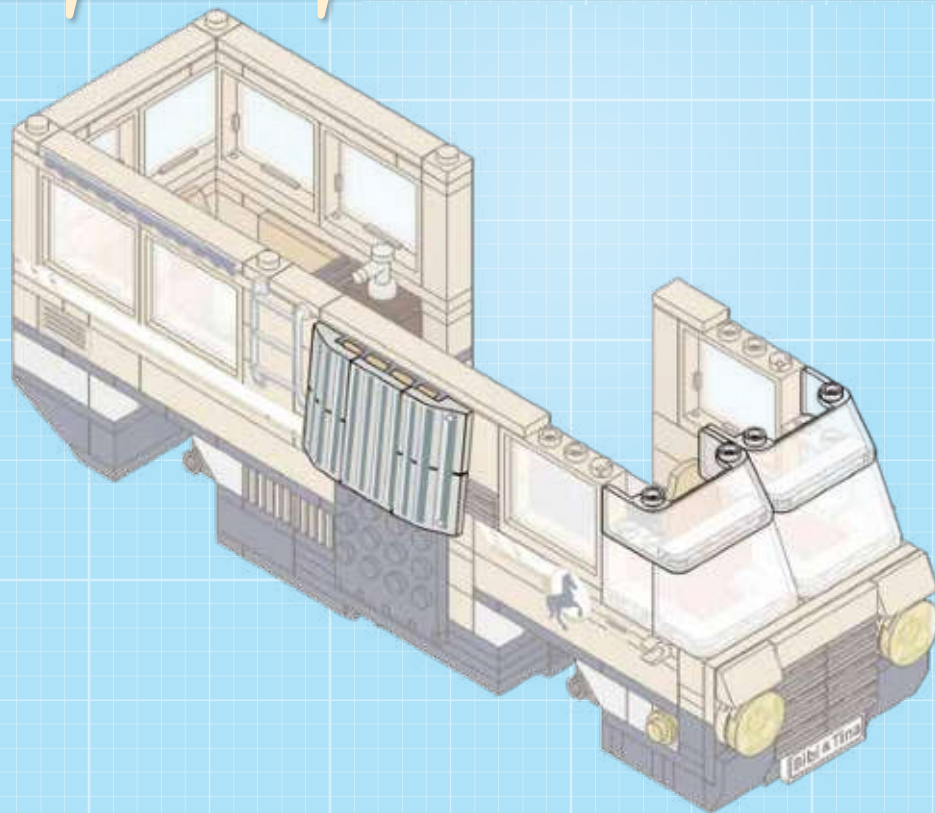
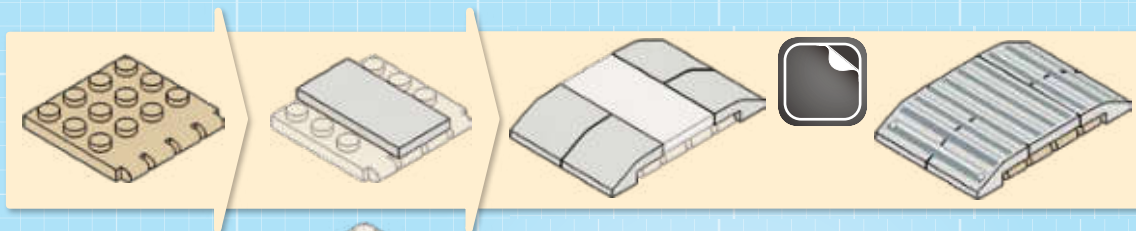
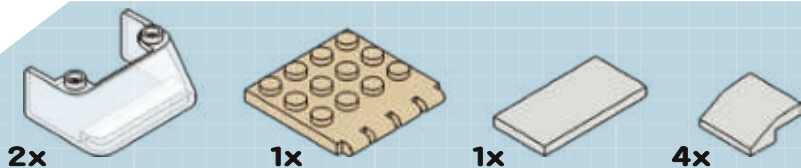

68

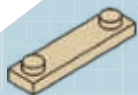

2x



1x



1x

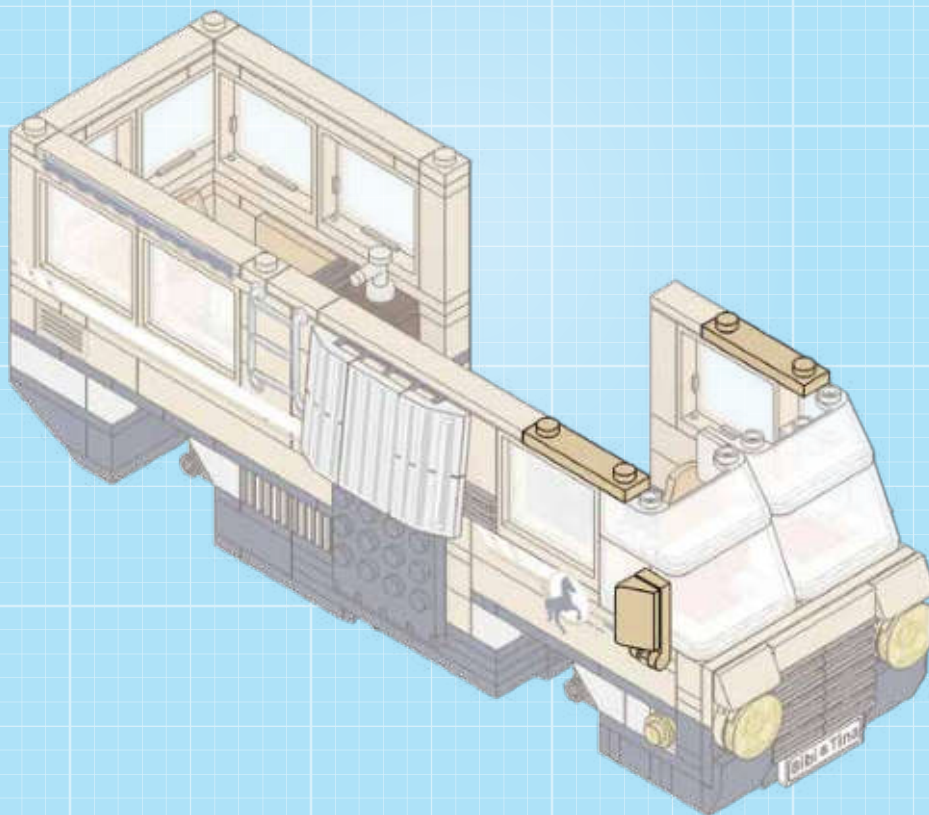
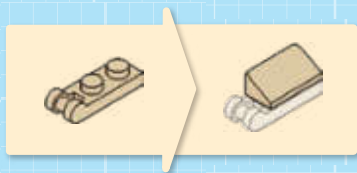

69

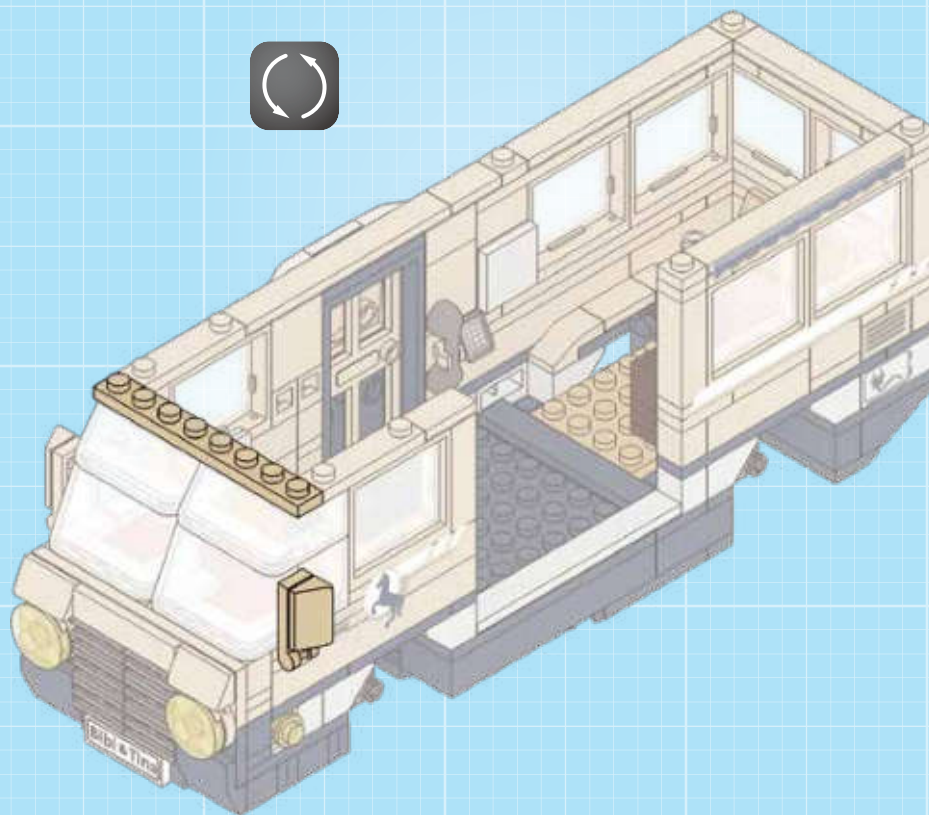
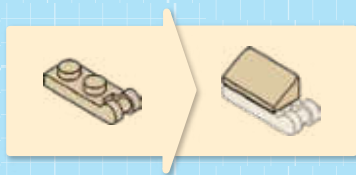
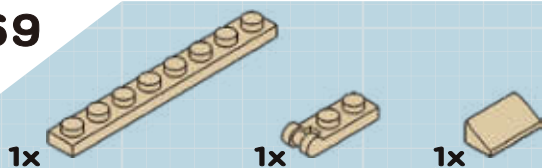

70

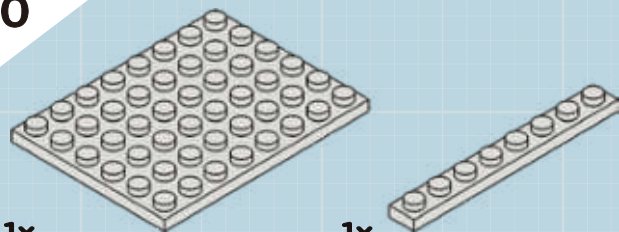

1x

1x

71



2x

1x

2x

2x

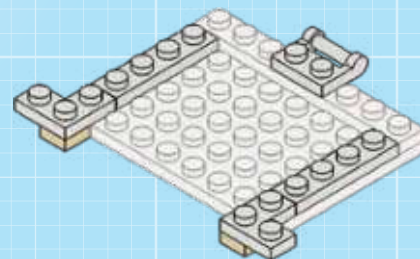
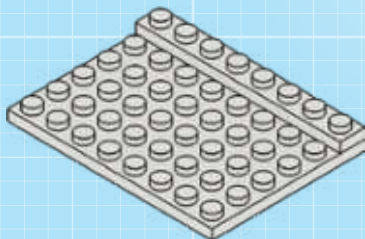
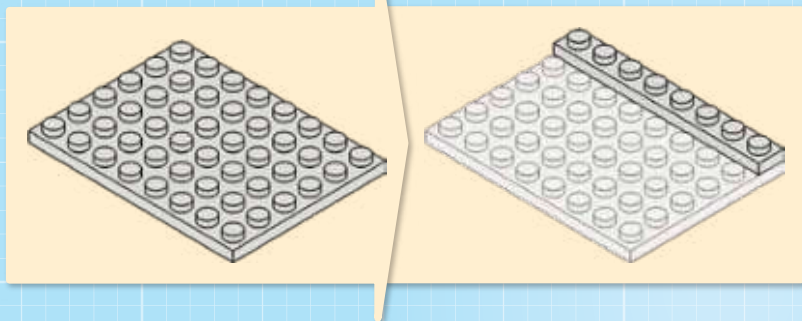

72

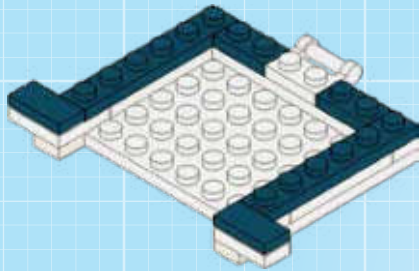
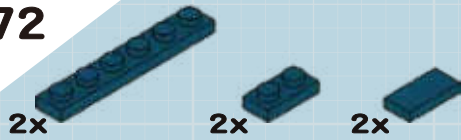

73

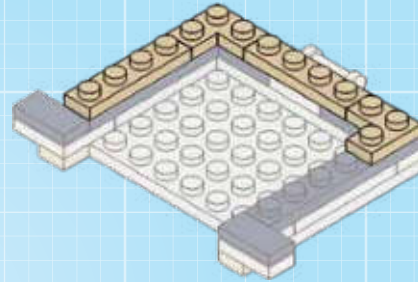

74

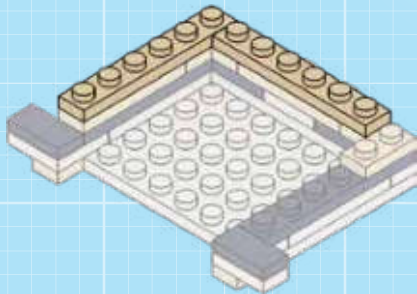
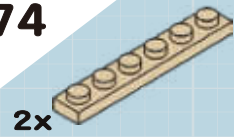

75

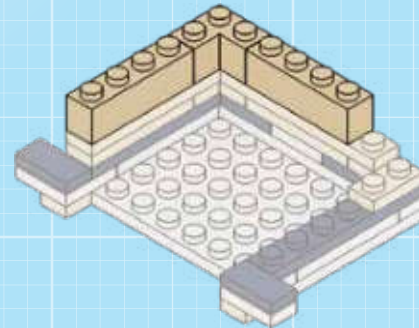
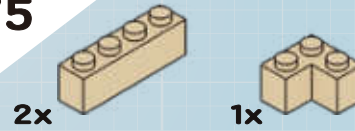

76

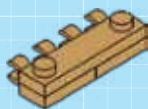
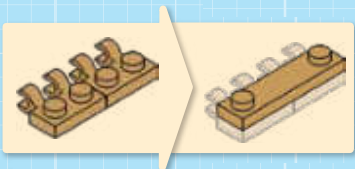

77

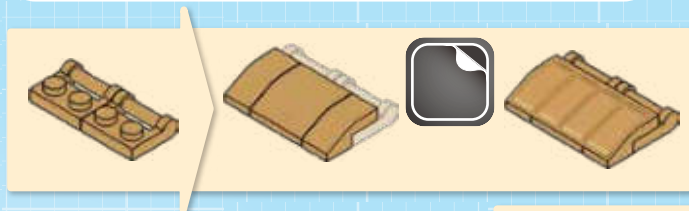

78

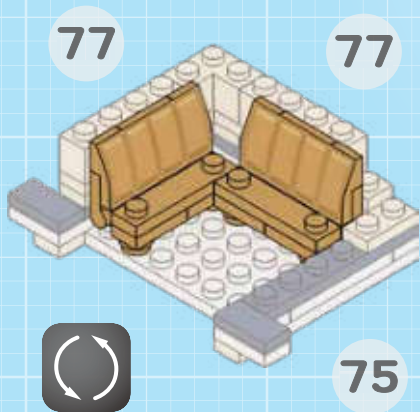

79

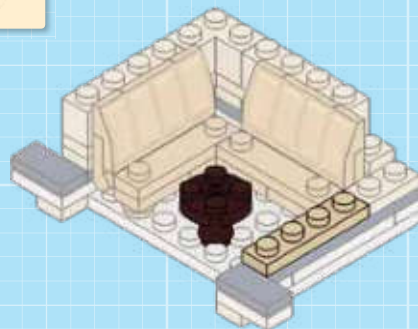
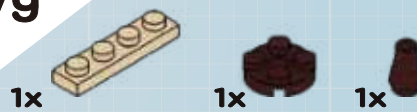

80

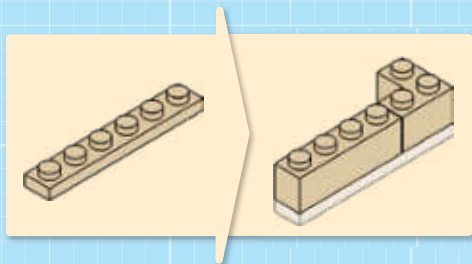
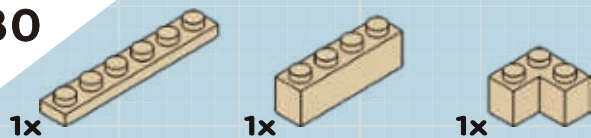

81

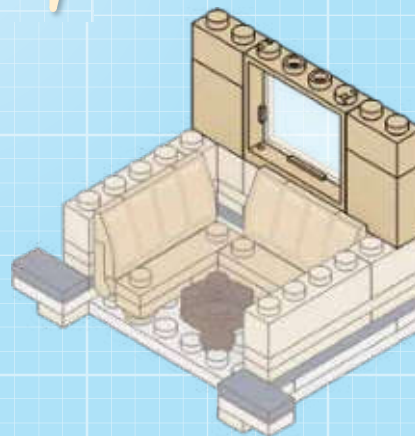
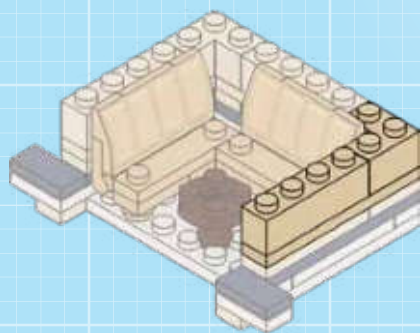
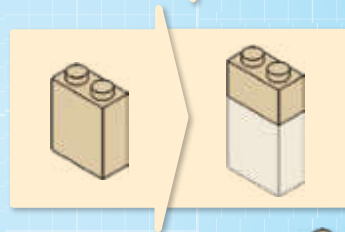
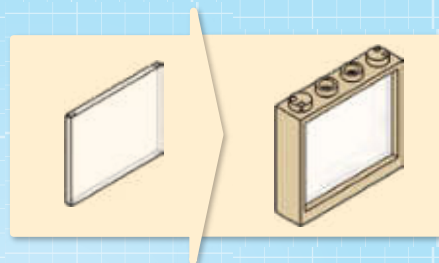
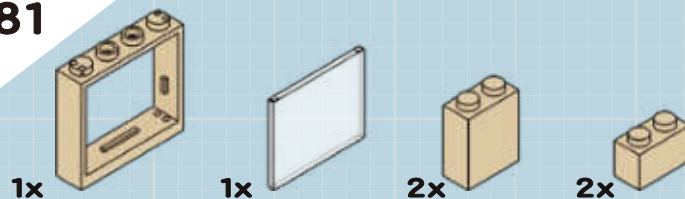

82

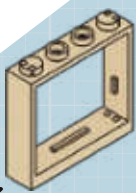

2x

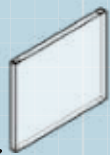

2x



2x



1x

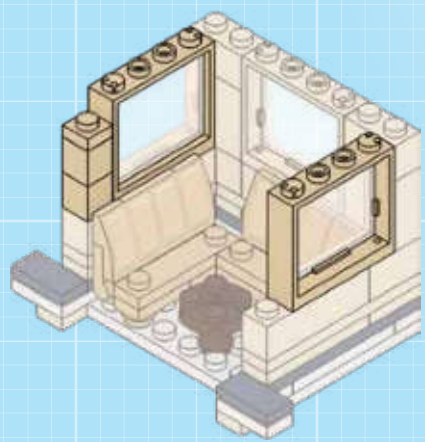
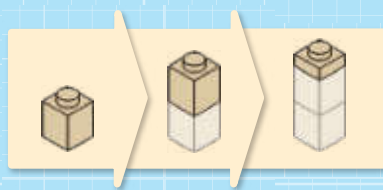
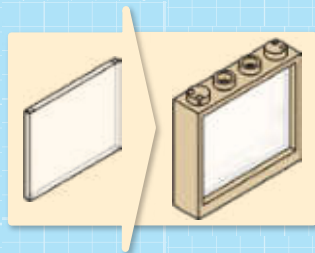

83



1x



1x



1x



1x



1x

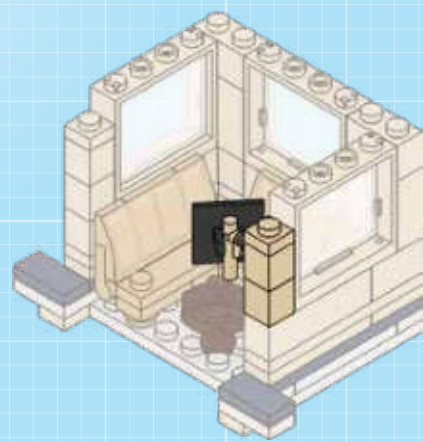
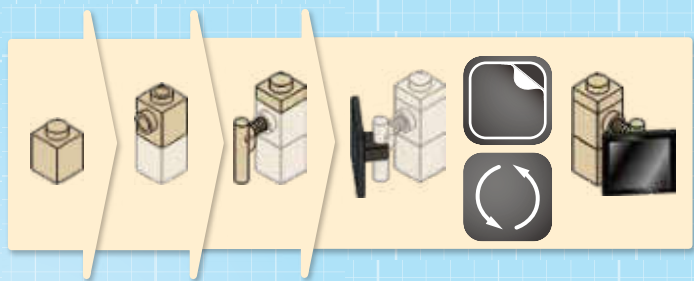

84

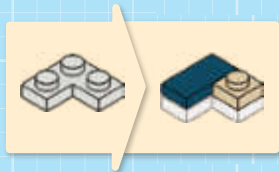
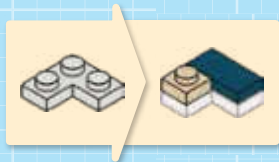

85

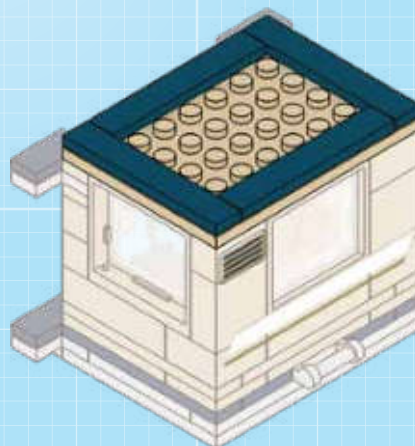
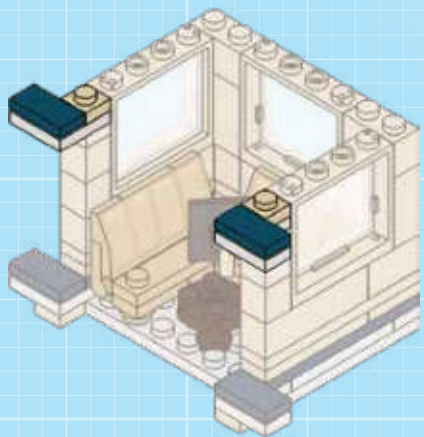
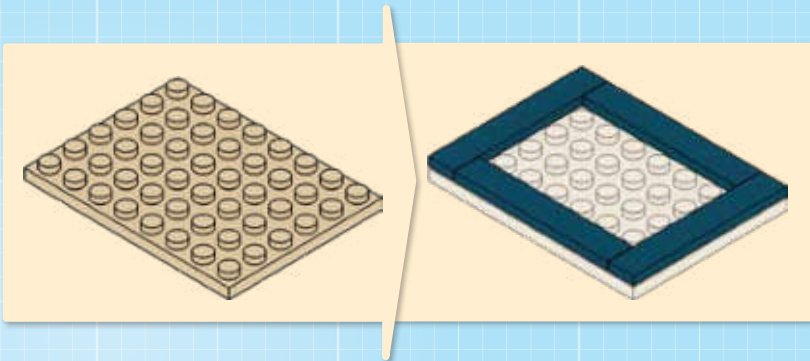

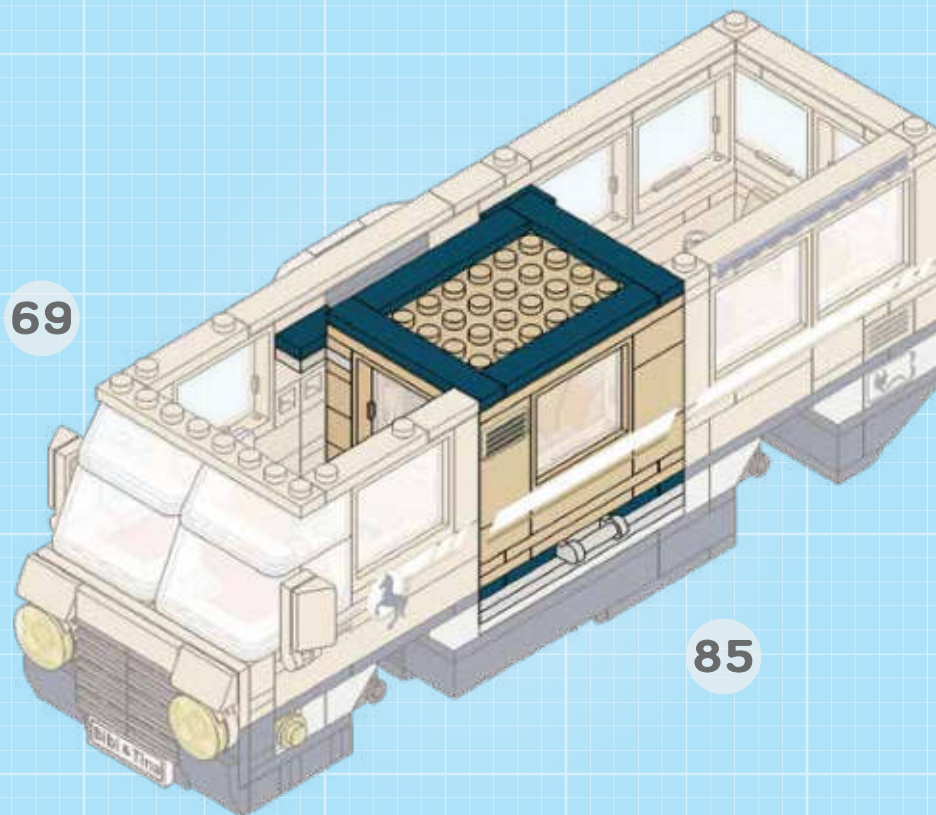

87

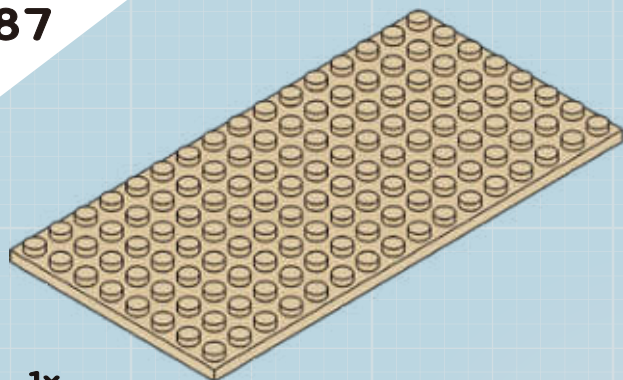

1x



1x

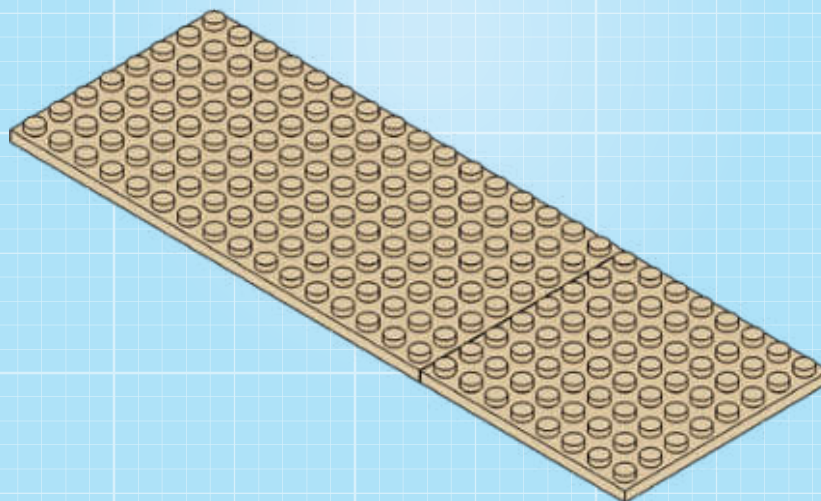

88

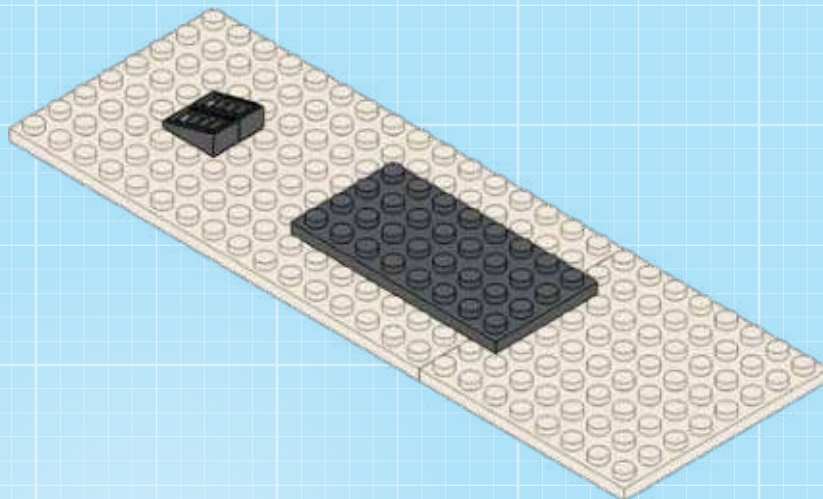
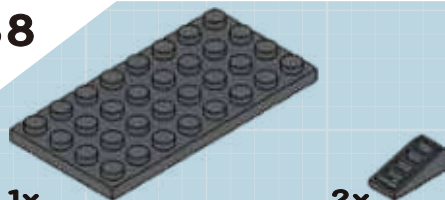

89

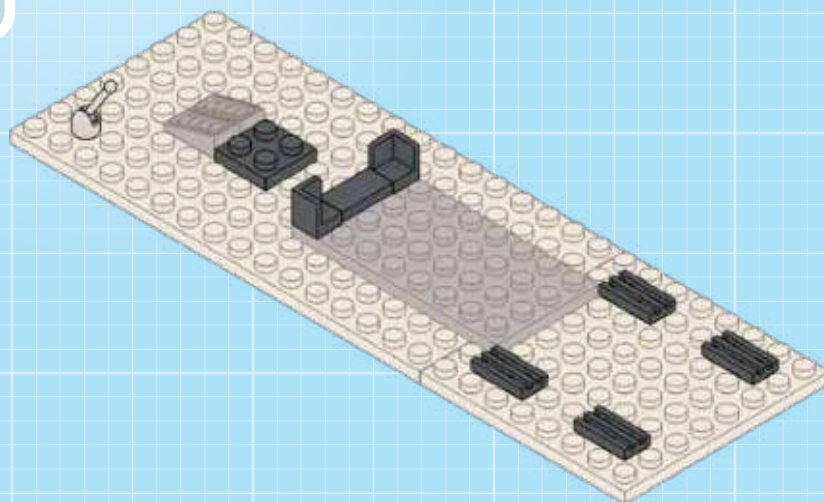
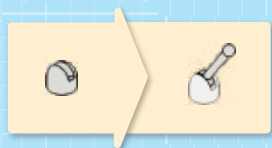
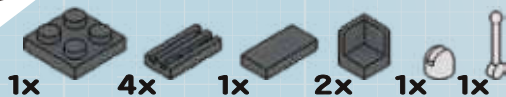

90

4x

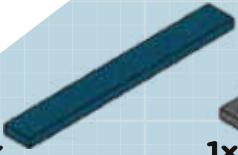

1x



1x



2x

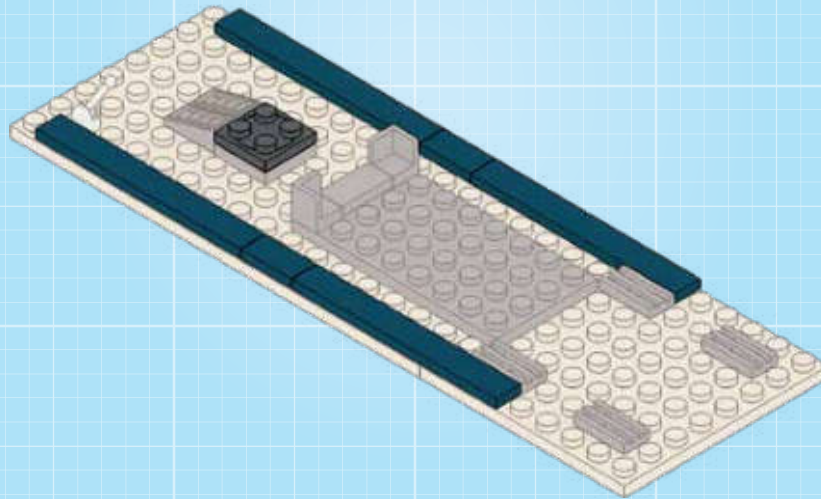
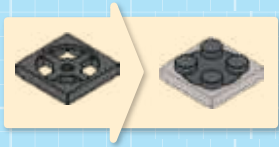

91

2x



2x



4x

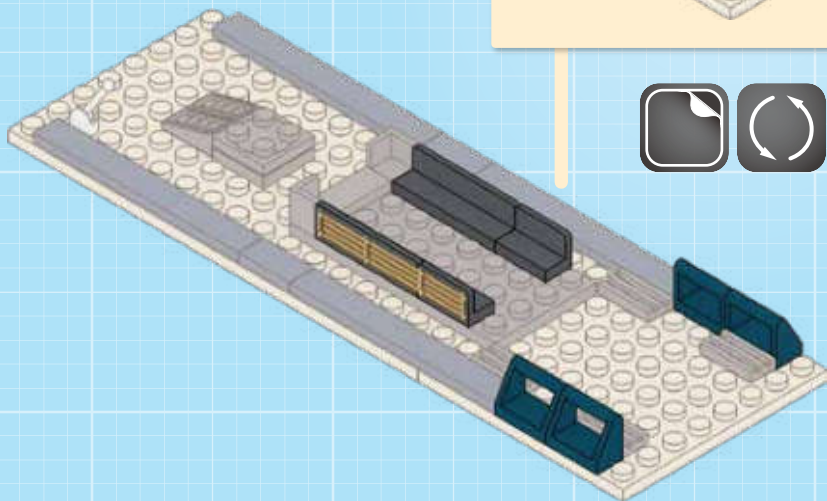
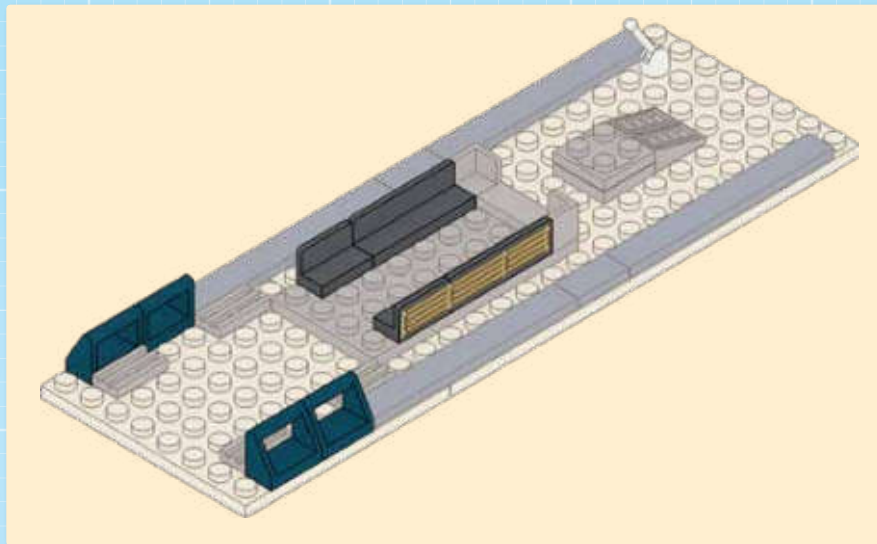

92

4x

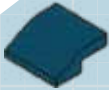

2x

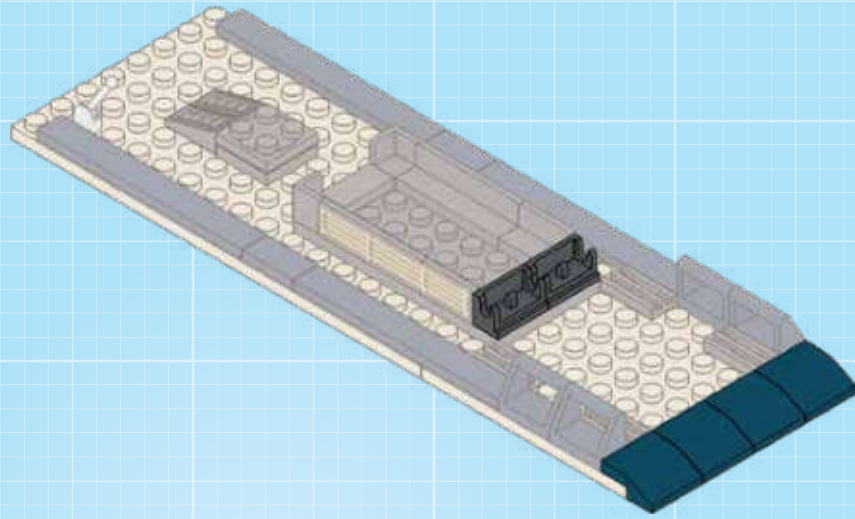

93

4x

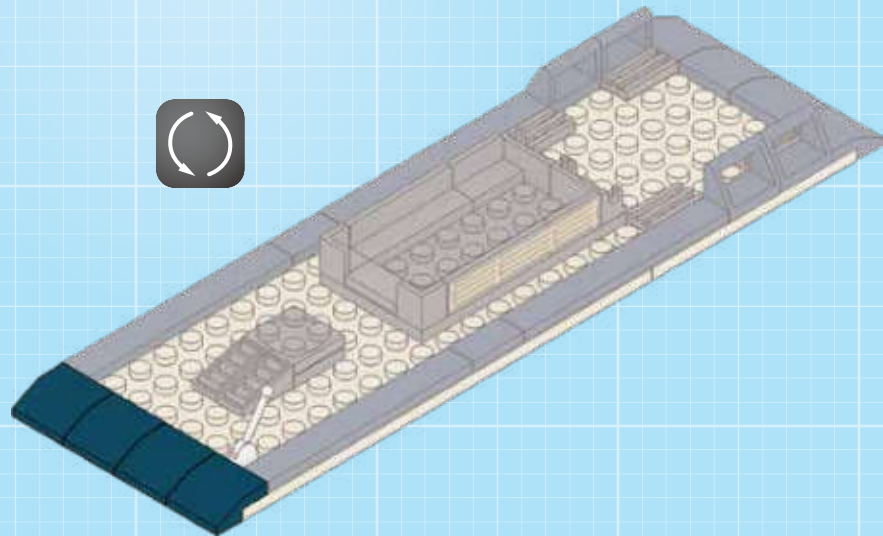
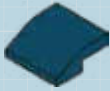

94

1x

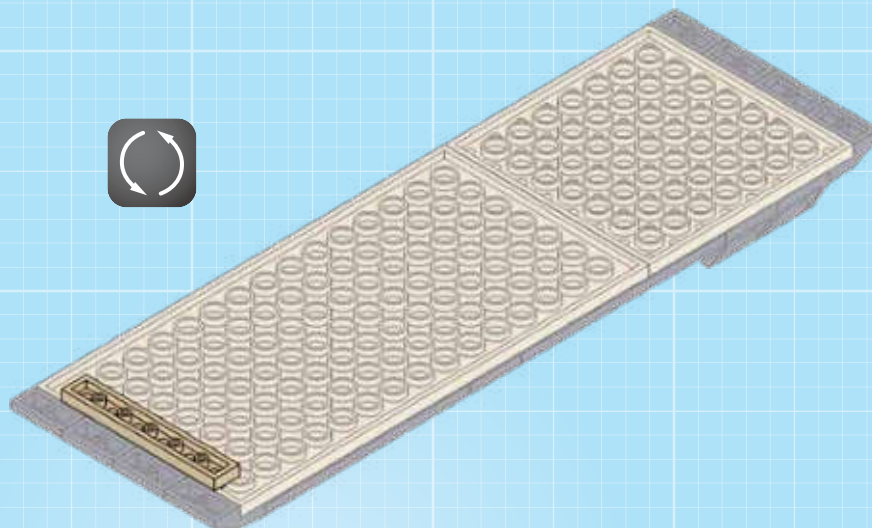
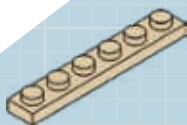

95

2x

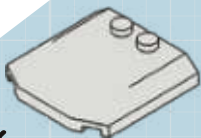

1x

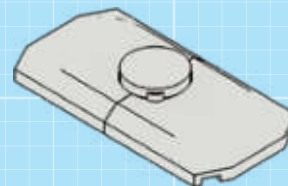
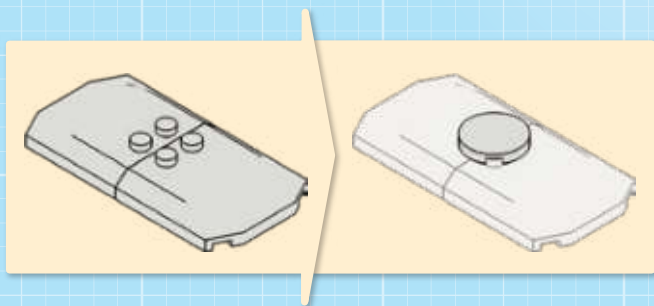

96

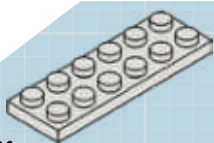

1x

97



1x



1x



2x

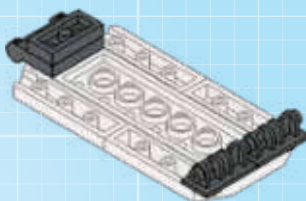
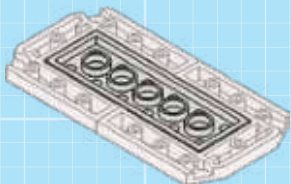
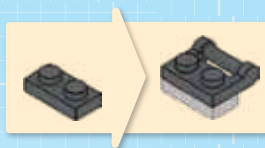

98

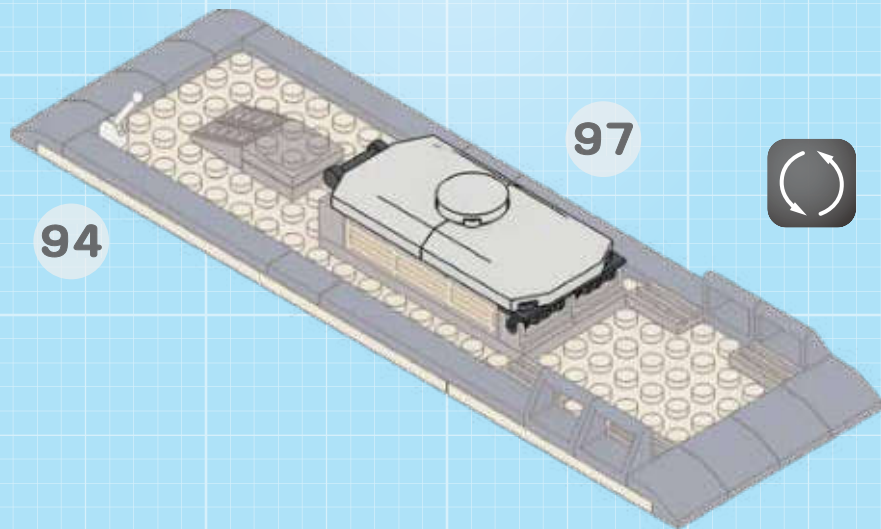

94

97



99

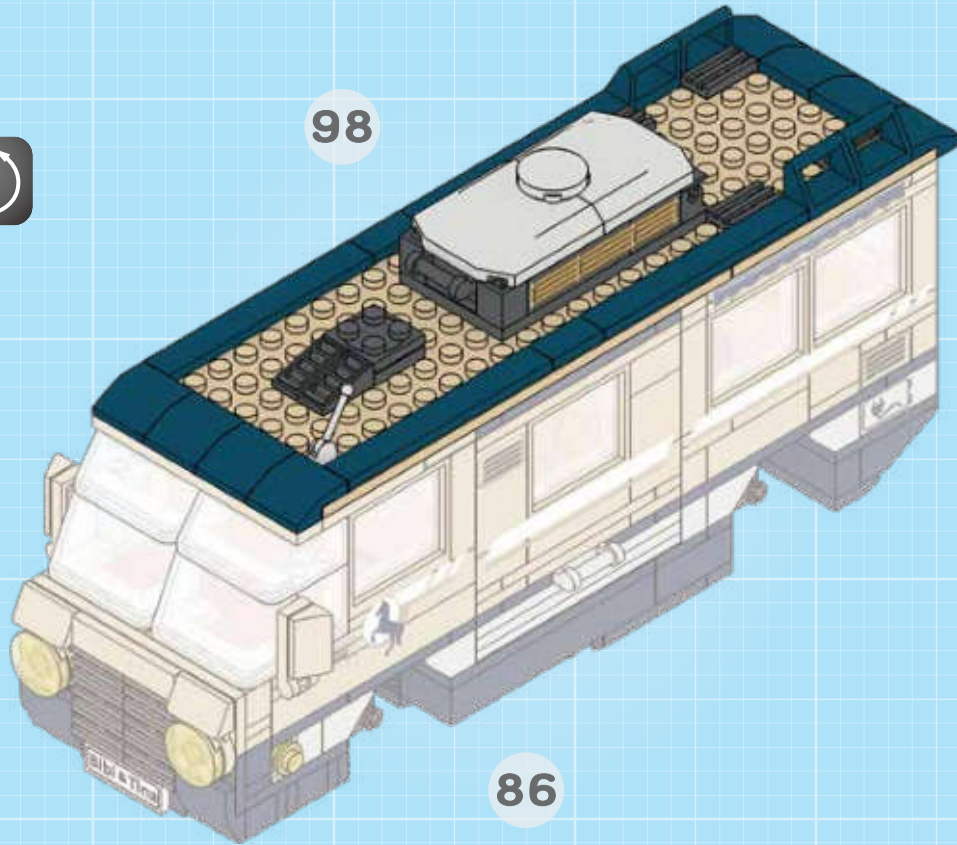

100



4x



4x

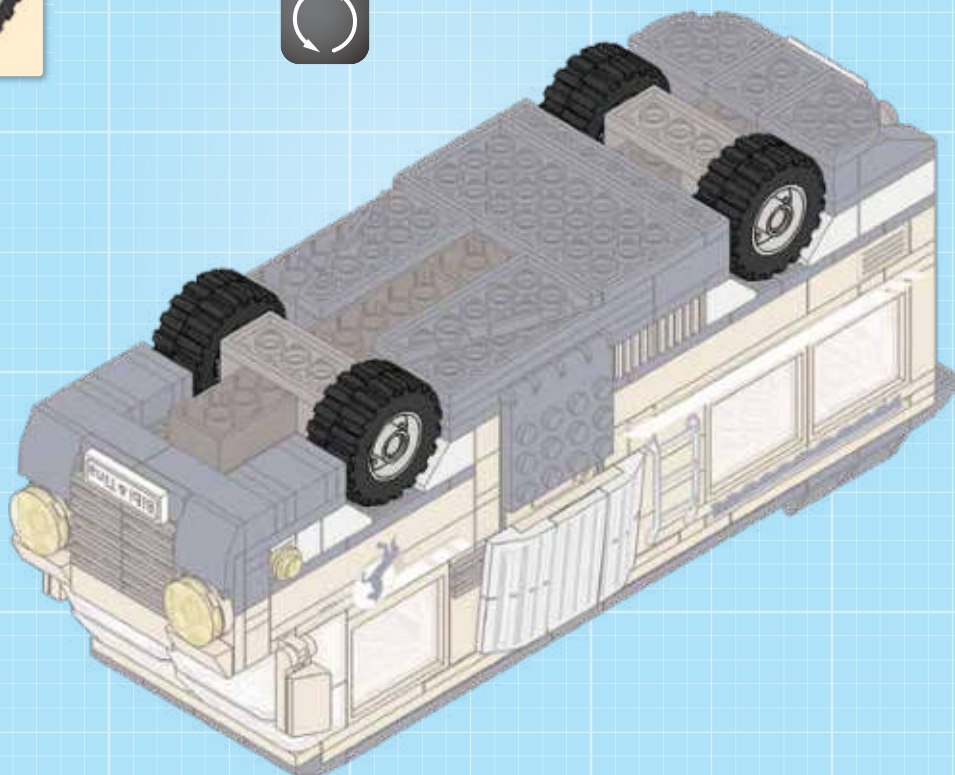

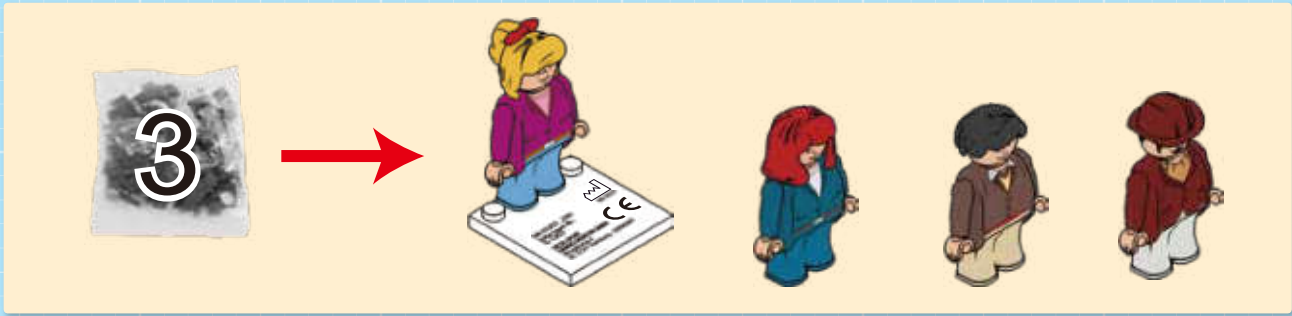

101

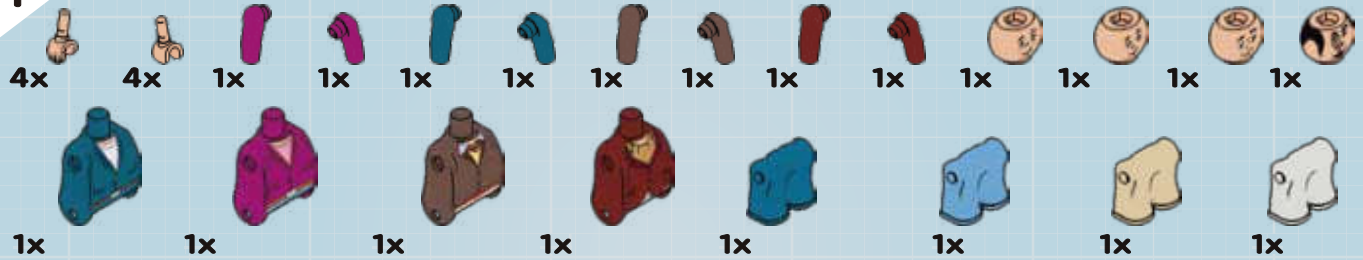

102

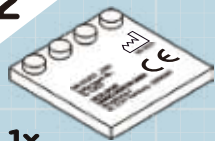

1x



1x



1x



1x



1x



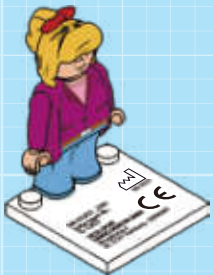
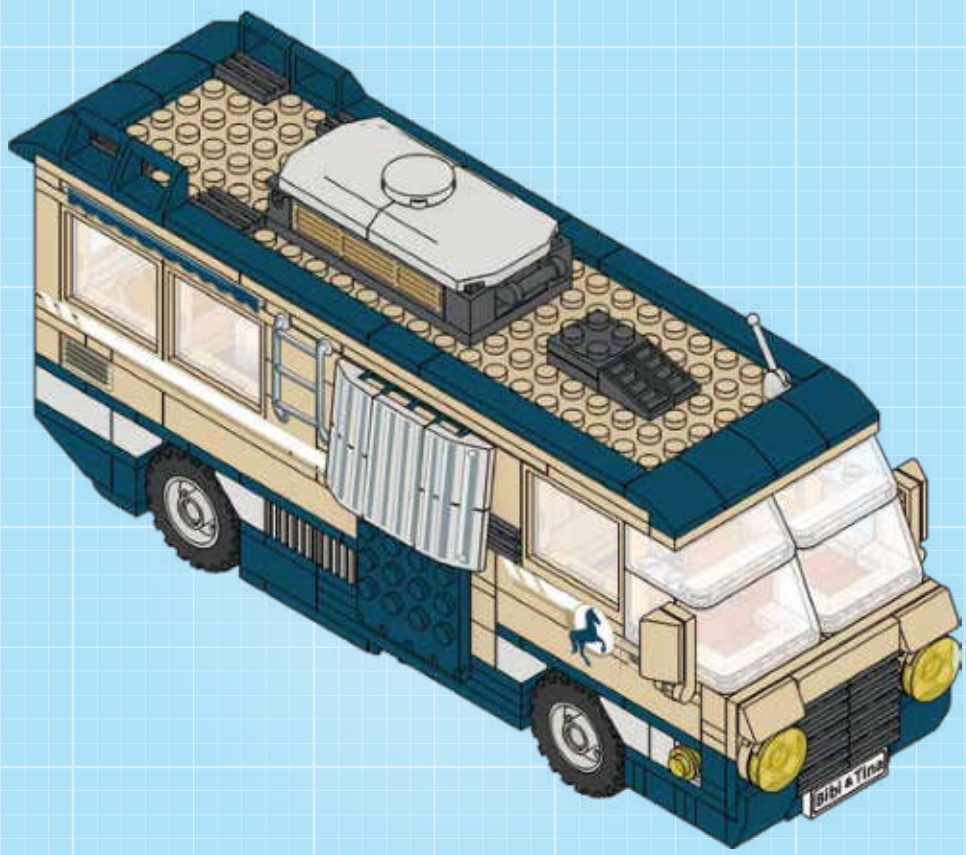

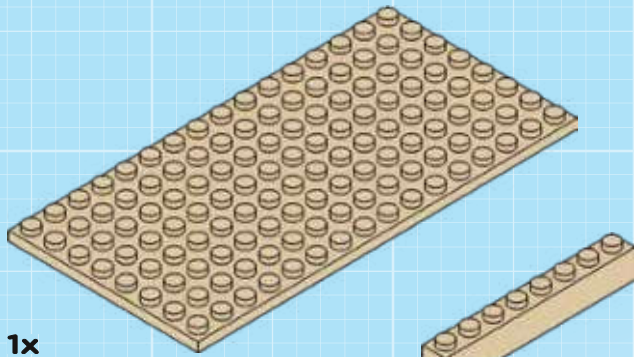

1x



1x



1x

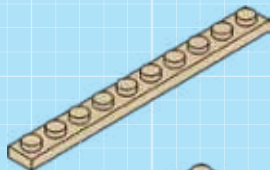

2x

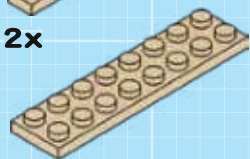

1x

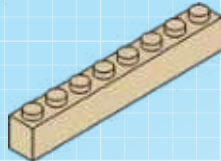

4x

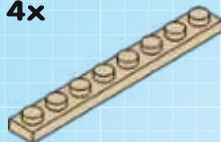

3x

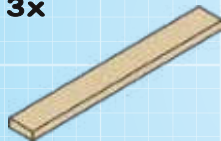

3x

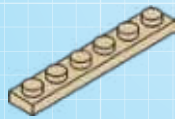

7x

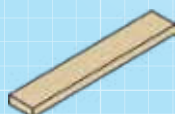

1x

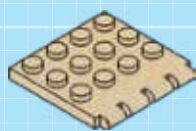

1x



1x

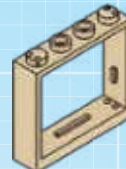

11x



2x



8x



7x



2x



1x



4x



2x



6x



2x



4x



2x



6x



2x



2x



10x



4x



4x



2x



1x



2x



1x



2x



2x



7x



2x



20x



2x

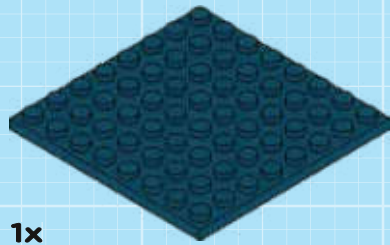

1x

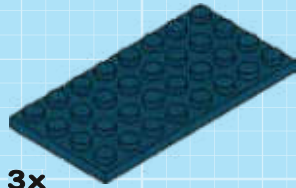

3x

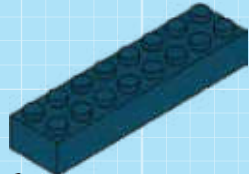

1x

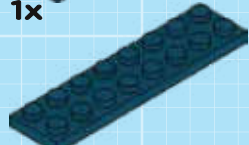

4x

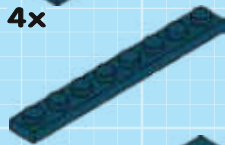

4x

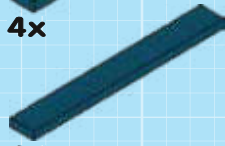

4x

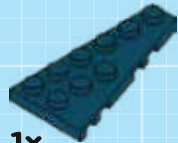

1x

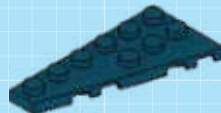

1x

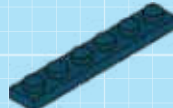

2x

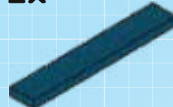

6x



1x

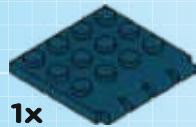

1x



1x

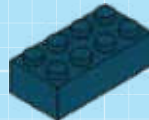

1x



2x



5x



2x



2x



2x



3x

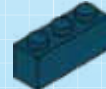

4x



2x



3x

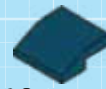

10x



2x



1x



2x



4x



12x



6x



7x



2x



3x

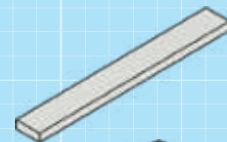

1x



1x

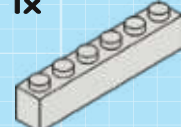

1x



2x

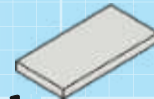

1x

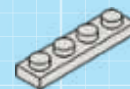

2x

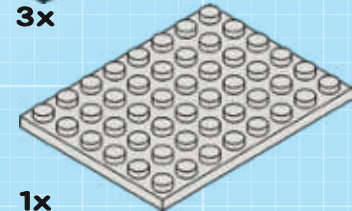

1x

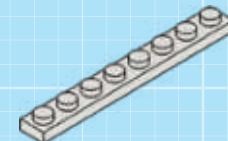

1x

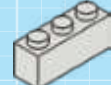

2x



4x



6x



1x



4x



2x



4x



1x



1x



2x



2x



1x



2x



1x



1x



1x



1x

1x

1x

1x

1x

1x

1x

1x

1x

1x

1x

1x

1x

1x

1x

1x

1x

1x

1x

1x

1x

1x

1x

1x

1x

1x

1x



1x



1x



2x



2x



4x



1x



2x



2x



1x



11x



1x



4x



2x



2x



1x



1x



4x



1x



1x



3x



2x



3x



6x



6x



6x

6x



1x



2x



2x



1x



1x



6x



1x



1x



1x



2x



2x



4x

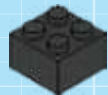

1x



1x



1x



1x



1x



1x



1x



1x



1x



1x



1x



1x



1x



1x



1x



1x

2x



1x



2x



1x



1x



2x

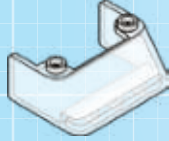

2x



2x



11x



2x



1x



2x



2x

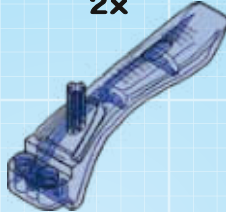

1x



1x



1x



1x

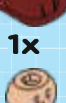

1x



1x



1x



1x



4x



4x



1x



1x



1x



1x



1x



1x



1x



1x



1x



1x



1x



1x



1x

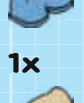

1x

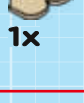

1x

