

BATHROOM CABINET PALERMO

 **Bathroom cabinet**
Assembly instruction

 **Bad-Seitenschrank**
Montageanleitung

GB	Assembly, safety and warranty instructions Assembly steps	Page	7-8 11-21
DE	Sicherheitshinweise, Garantie Zusammenbau	Seite	9-10 11-21

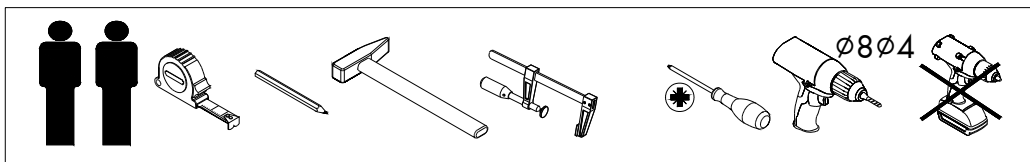
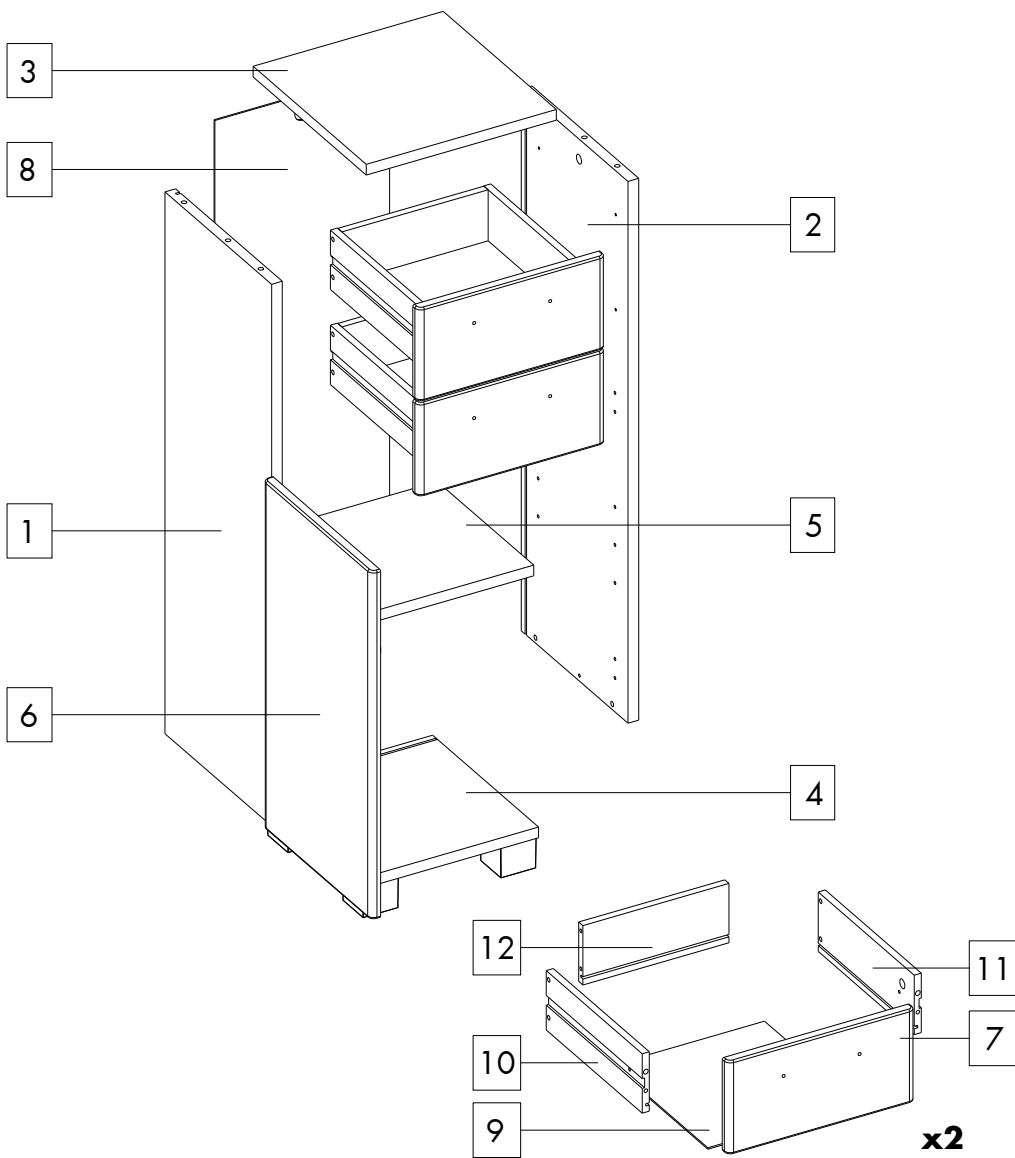

1

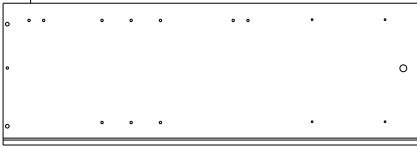

2

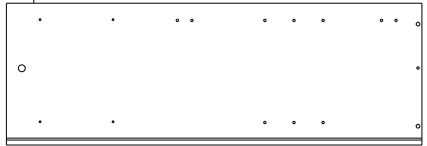

3

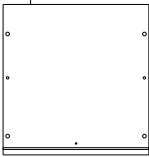

4

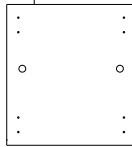

5

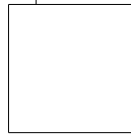

6



7 **x2**

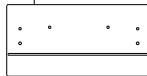

8

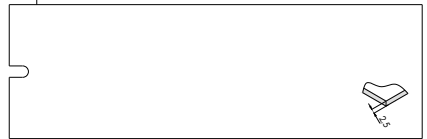

9 **x2**



10 **x2**



11 **x2**



12 **x2**

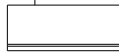

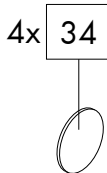
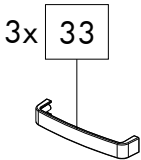
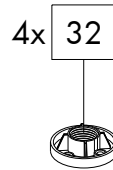
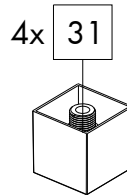
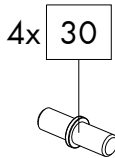
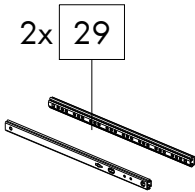
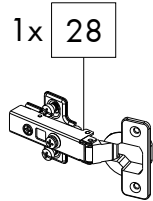
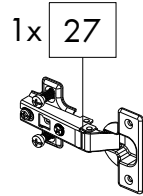
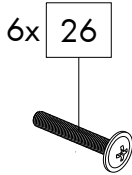
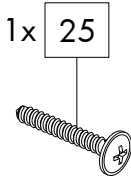
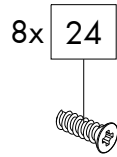
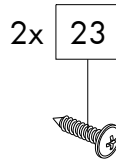
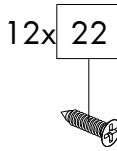
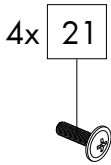
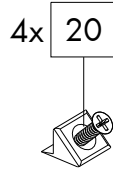
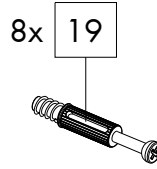
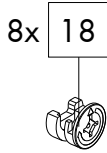
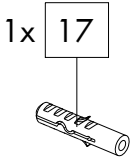
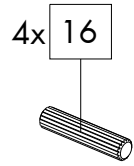
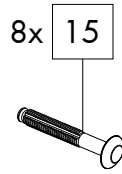
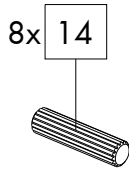
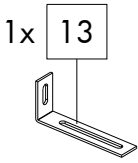

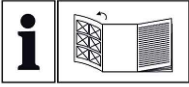

GB MT IE NI CY

Before reading, unfold the page containing the illustrations and familiarise yourself with all functions of the product.

DE AT CH BE

Klappen Sie vor dem Lesen die Seite mit den Abbildungen aus und machen Sie sich anschließend mit allen Funktionen des Produkts vertraut.

Congratulations!

You have chosen a high-quality product. The operating instructions are part of this product. They contain important information about safety, usage and disposal. Before using the product, please familiarise yourself with all operating and safety instructions. Use the product only as described and for the range of applications specified. Please also pass these operating instructions on to any future owner.

Intended use

This product is intended solely for private use and not for commercial purposes. The warranty shall be deemed void in cases of misuse or improper handling, use of force and modifications / repairs which have not been carried out by one of our authorised Service centres.

Safety instructions

Warning: Please follow directly the manufacturer assembly instruction. Deficient assembly causes safety risks. Please check if the surface is appropriate and choose appropriate fasteners. Assembling by qualified personnel is recommended.

Warning! Furniture consists small parts.

Warning! Children under 3 years shall not be unattended.

Wall fixing /ANTI-TOPPLE WARNING

This product has to be permanently fixed to the wall with the bracket(s) included, to avoid fatal injury in case it topples over. In case of connective devices for the wall mounting, the supporting material must be checked for suitability.

Care instructions

Please do only clean with a duster or a damp cloth.

Do not use any scouring agents!



Warranty

Dear customer, this appliance comes with a 3-year warranty valid from the date of purchase. In the event that this product has any defects, you, the buyer, have certain statutory rights. Your statutory rights are not limited in any way by the warranty described below.

Warranty conditions

The warranty period starts on the date of purchase. Please keep your receipt in a safe place. This will be required as proof of purchase. If any material or manufacturing fault occurs within 3 years of the product's date of purchase, we will either repair or replace the product for you or refund the purchase price (at our discretion). This warranty service requires that you present the defective appliance and the proof of purchase (receipt) within the 3-year warranty period, together with a brief written description of the fault and of when it occurred. If the defect is covered by the warranty, your product will either be repaired or replaced by us. The repair or replacement of a product does not signify the beginning of a new warranty period.

Warranty period and statutory claims for defects

The warranty period is not prolonged by repairs effected under the warranty. This also applies to replaced and repaired components. Any damage and defects present at the time of purchase must be reported immediately after unpacking. Repairs carried out after expiry of the warranty period shall be subject to a fee.

Scope of the warranty

This appliance has been manufactured in accordance with strict quality guidelines and inspected meticulously prior to delivery. The warranty covers material faults or production faults. The warranty does not extend to product parts subject to normal wear and tear or to fragile parts which could be considered as consumable parts such as switches or parts made of glass. The warranty does not apply if the product has been damaged, improperly used or improperly maintained. The directions in the operating instructions for the product regarding proper use of the product are to be strictly followed. Uses and actions that are discouraged in the operating instructions or which are warned against must be avoided

Disposal

Please dispose packaging and product after use in an environmentally sound manner.

Herzlichen Glückwunsch!

Sie haben sich damit für ein hochwertiges Produkt entschieden. Die Bedienungsanleitung ist Teil dieses Produkts. Sie enthält wichtige Hinweise für Sicherheit, Gebrauch und Entsorgung. Machen Sie sich vor der Benutzung des Produkts mit allen Bedien- und Sicherheitshinweisen vertraut. Benutzen Sie das Produkt nur wie beschrieben und für die angegebenen Einsatzbereiche. Händigen Sie alle Unterlagen bei Weitergabe des Produkts an Dritte mit aus.

Bestimmungsgemäße Verwendung

Das Produkt ist lediglich für den privaten und nicht für den gewerblichen Gebrauch bestimmt. Bei missbräuchlicher und unsachgemäßer Behandlung, Gewaltanwendung und bei Eingriffen, die nicht von unserer autorisierten Service-Niederlassung vorgenommen wurden, erlischt die Garantie.

Sicherheitshinweis

Achtung: Die Montage muss exakt nach den Anweisungen des Herstellers erfolgen - anderenfalls kann eine fehlerhafte Montage zu einem Sicherheitsrisiko führen. Bei mangelhafter Montage besteht Gefahr für die Sicherheit. Prüfen Sie bitte den Untergrund auf Eignung und wählen Sie geeignete Befestigungsmittel. Aufbau durch fachkundiges Personal empfohlen!

Achtung! Möbel enthält verschluckbare Kleinteile.

Achtung! Kinder < 3 Jahre nicht ohne Beaufsichtigung lassen.

Wandmontage

WARNHINWEIS: Um ein Umkippen zu verhindern, ist dieses Produkt mit dem mitgelieferten Schrankaufhänger zu verwenden. Bei Verbindungsmittel für die Wandbefestigung ist das Trägermaterial auf Eignung zu prüfen.

Pflegehinweis

Bitte nur mit einem Staubtuch oder einem feuchten Lappen reinigen. Keine scheuernden Putzmittel verwenden!



Garantiezeit und gesetzliche Mängelansprüche

Die Garantiezeit wird durch die Gewährleistung nicht verlängert. Dies gilt auch für ersetzte und reparierte Teile. Eventuell schon beim Kauf vorhandene Schäden und Mängel müssen sofort nach dem Auspacken gemeldet werden. Nach Ablauf der Garantiezeit anfallende Reparaturen sind kostenpflichtig.

Garantieumfang

Das Produkt wurde nach strengen Qualitätsrichtlinien sorgfältig produziert und vor Anlieferung gewissenhaft geprüft. Die Garantieleistung gilt für Material- oder Fabrikationsfehler. Diese Garantie erstreckt sich nicht auf Produktteile, die normaler Abnutzung ausgesetzt sind und daher als Verschleißteile angesehen werden können oder für Beschädigungen an zerbrechlichen Teilen, z. B. Schalter, oder Teile, die aus Glas gefertigt sind. Diese Garantie verfällt, wenn das Produkt beschädigt, nicht sachgemäß benutzt oder gewartet wurde. Für eine sachgemäße Benutzung des Produkts sind alle in der Bedienungsanleitung aufgeführten Anweisungen genau einzuhalten. Verwendungszwecke und Handlungen, von denen in der Bedienungsanleitung abgeraten oder vor denen gewarnt wird, sind unbedingt zu vermeiden.

Garantie

Sehr geehrte Kundin,
sehr geehrter Kunde, Sie erhalten auf dieses Produkt 3 Jahre Garantie ab Kaufdatum. Im Falle von Mängeln dieses Produkts stehen Ihnen gegen den Verkäufer des Produkts gesetzliche Rechte zu. Diese gesetzlichen Rechte werden durch unsere im Folgenden dargestellte Garantie nicht eingeschränkt.

Garantiebedingungen

Die Garantiefrist beginnt mit dem Kaufdatum. Bitte bewahren Sie den Original Kassenbon gut auf. Dieser wird als Nachweis für den Kauf benötigt. Tritt innerhalb von drei Jahren ab dem Kaufdatum dieses Produkts ein Material- oder Fabrikationsfehler auf, wird das Produkt von uns - nach unserer Wahl - für Sie kostenlos repariert, ersetzt, oder der Kaufpreis erstattet. Diese Garantieleistung setzt voraus, dass innerhalb der Drei-Jahres-Frist das defekte Produkt und der Kaufbeleg (Kassenbon) vorgelegt und schriftlich kurz beschrieben wird, worin der Mangel besteht und wann er aufgetreten ist. Wenn der Defekt von unserer Garantie gedeckt ist, erhalten Sie das reparierte oder ein neues Produkt zurück. Mit Reparatur oder Austausch des Produkts beginnt kein neuer Garantiezeitraum.

Entsorgung

Bitte entsorgen Sie Verpackung und Produkt nach der Verwendung umweltgerecht.

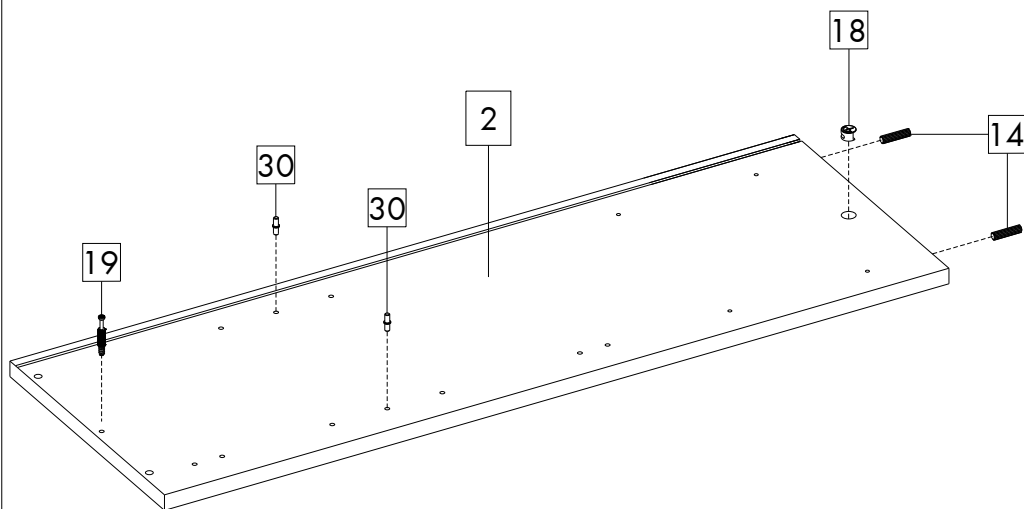
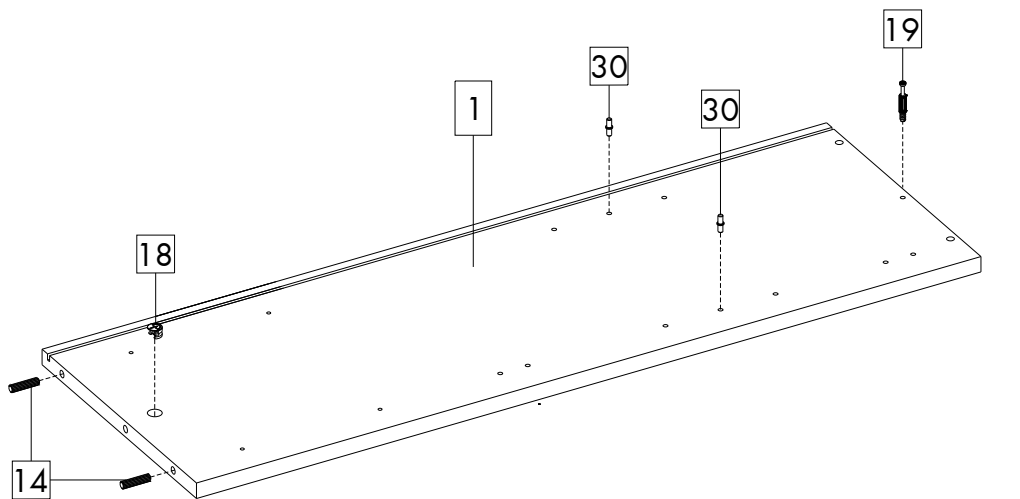
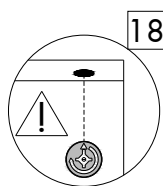
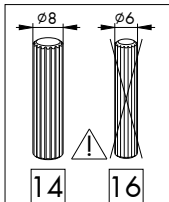
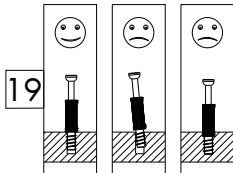
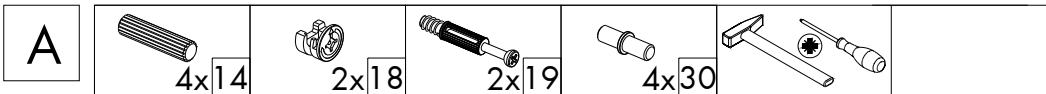

B

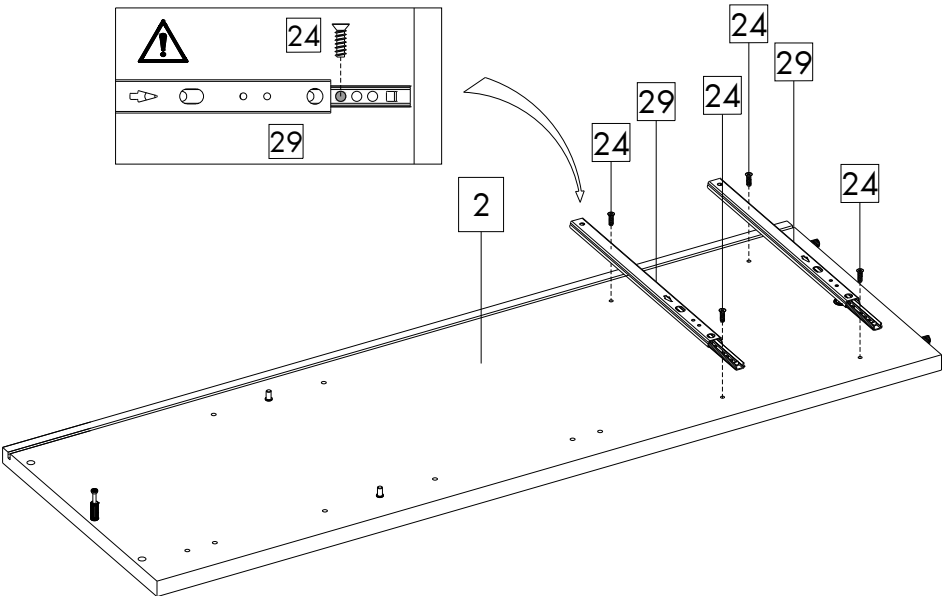
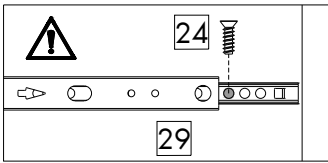
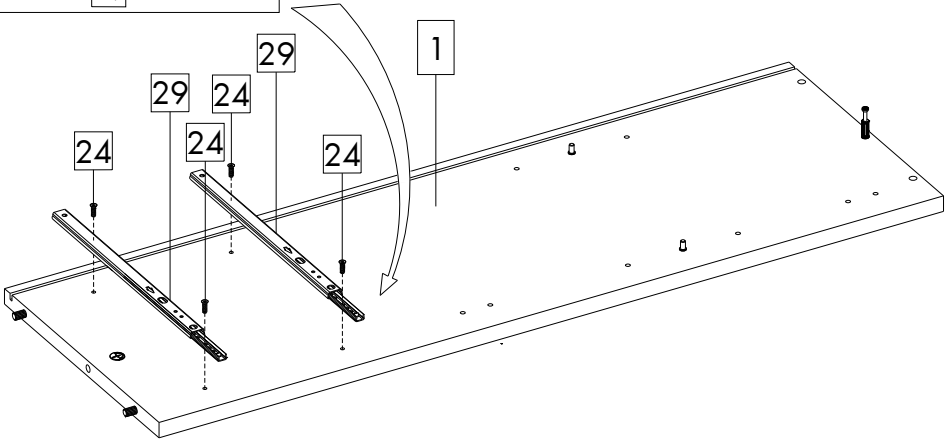
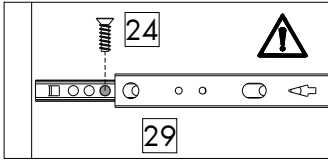
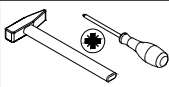
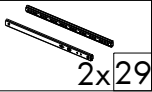
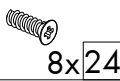

C

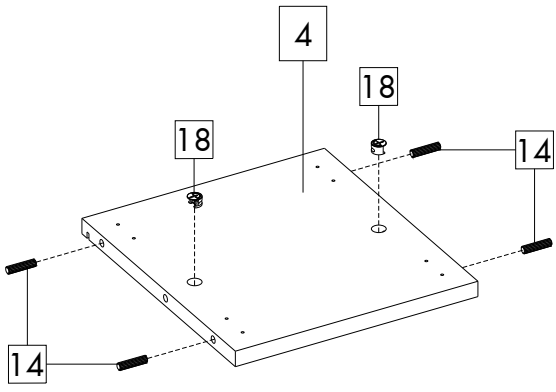
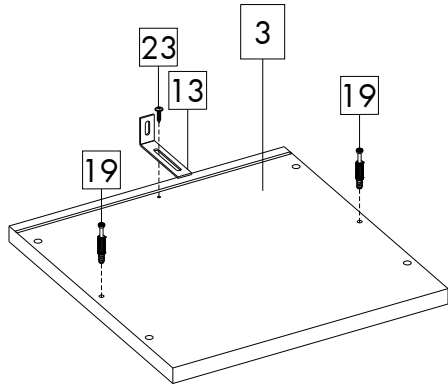
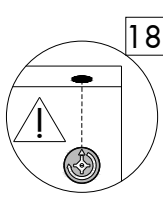
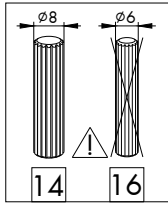
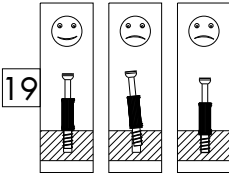
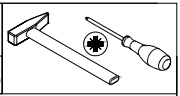
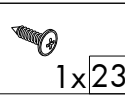
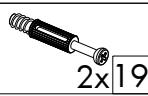
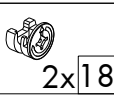
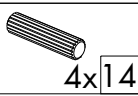
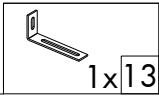

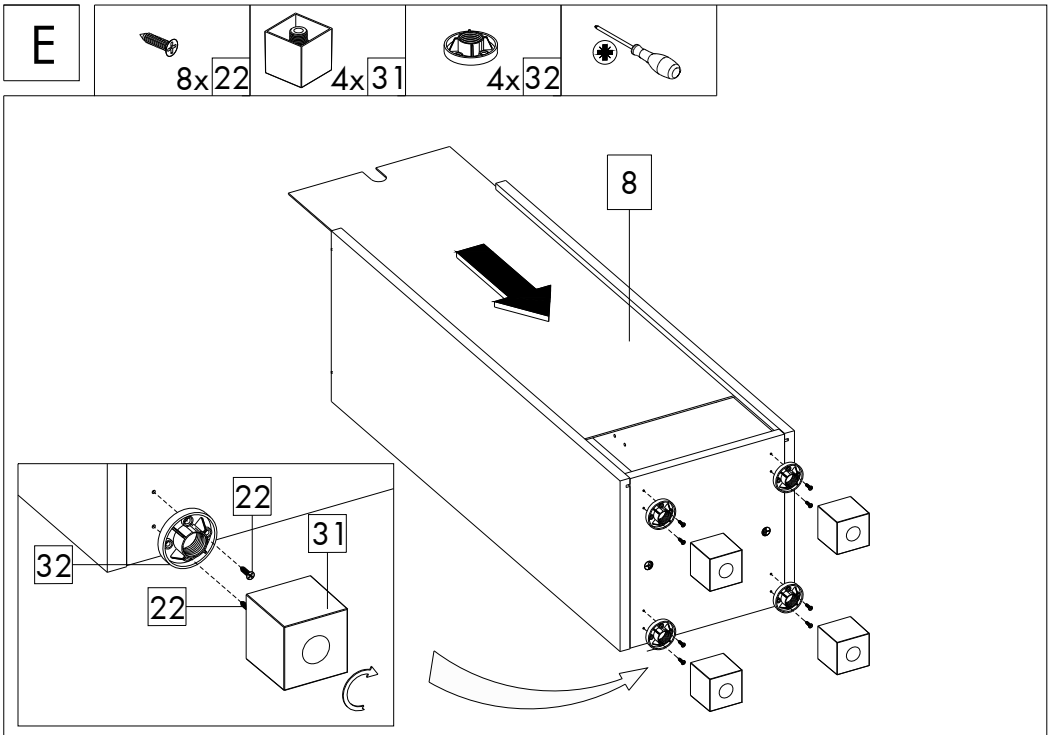
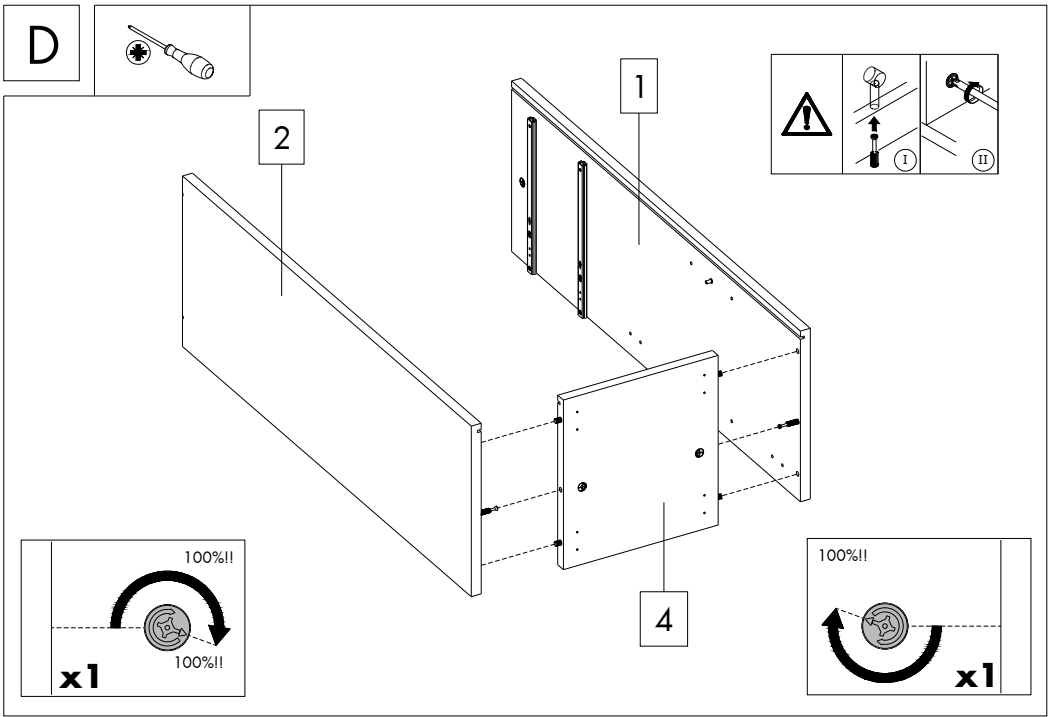

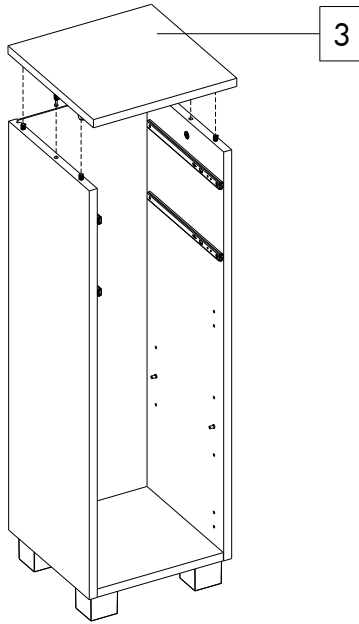
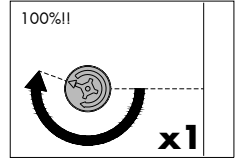
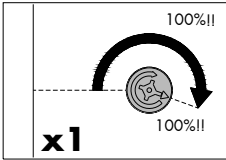
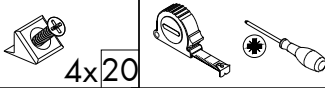
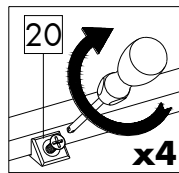
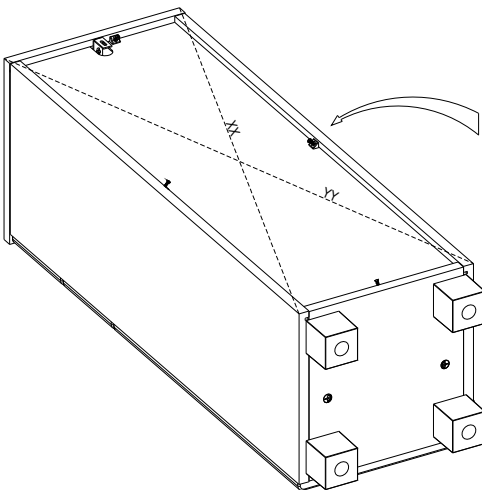
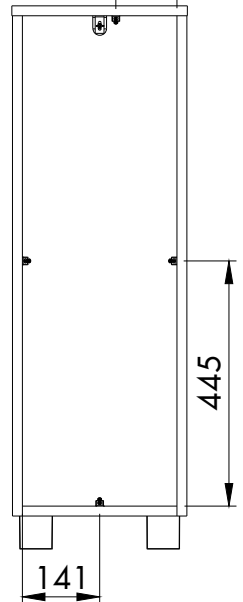
F**3****G****4x20** $XX=YY \cong 90^\circ$ **110****141**

H

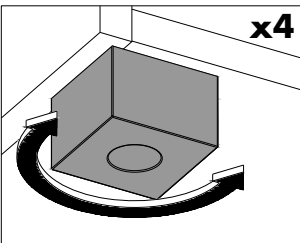
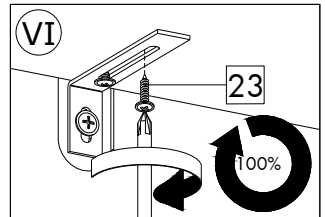
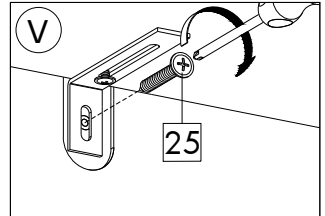
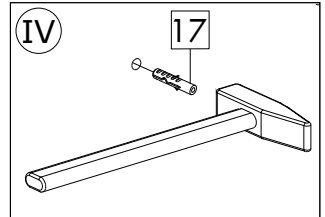
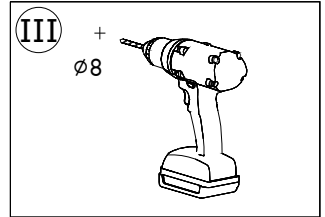
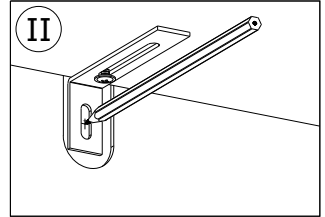
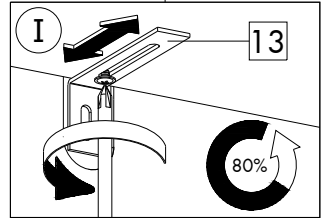
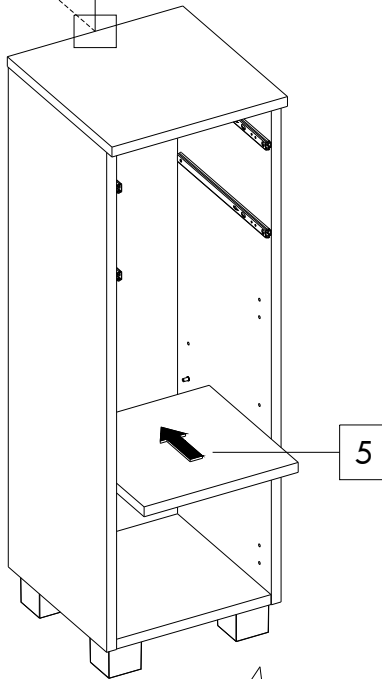
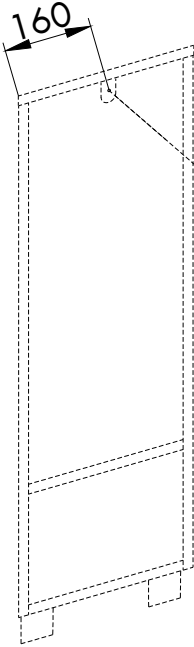
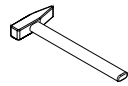
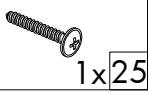
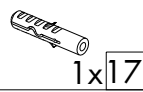

I

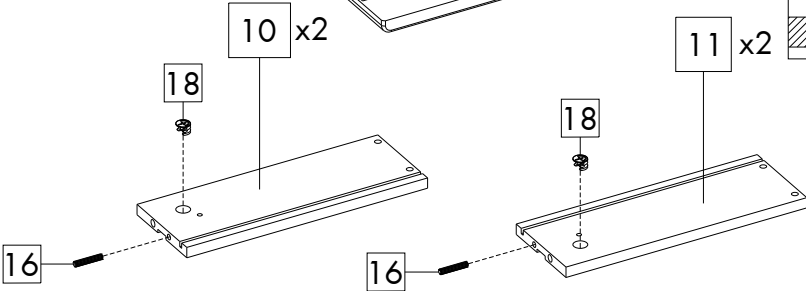
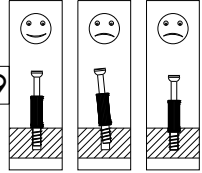
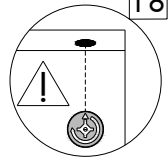
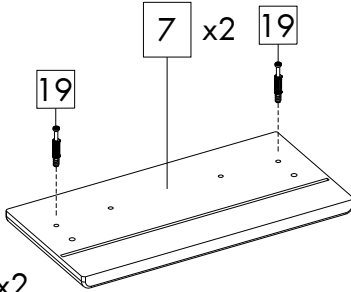
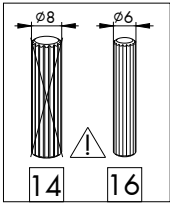
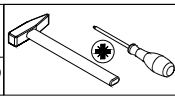
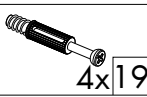
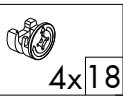
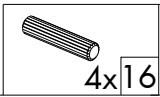

J

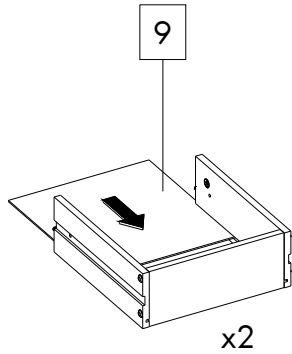
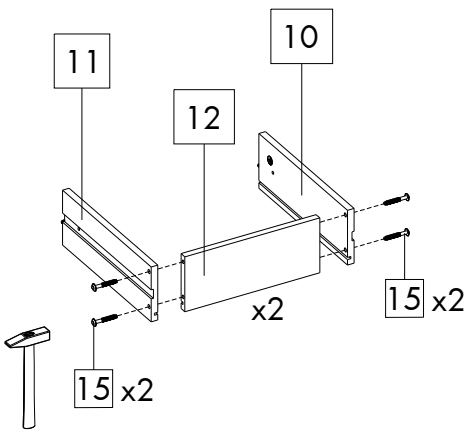
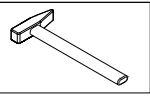
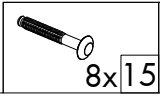

K

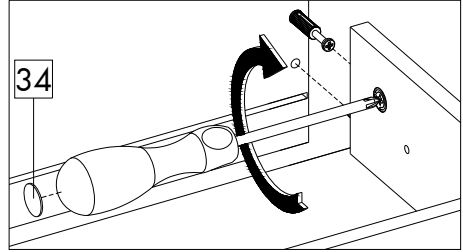
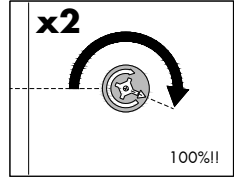
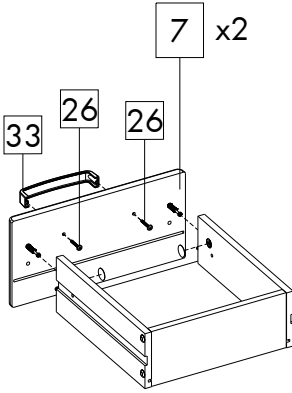
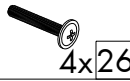
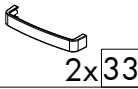
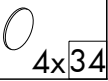

L

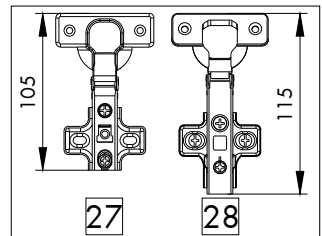
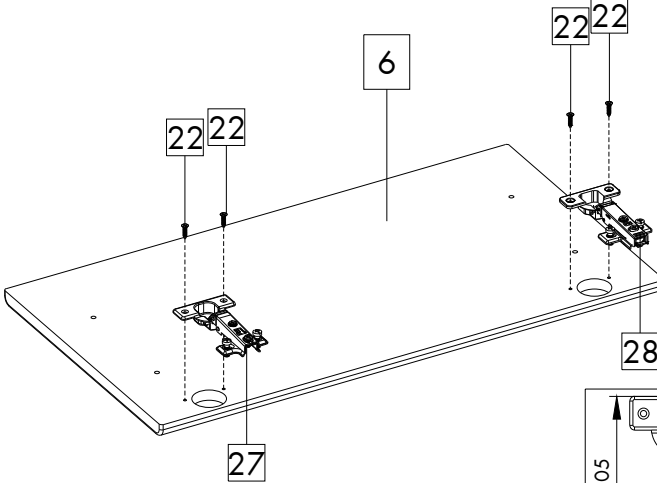
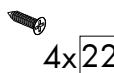
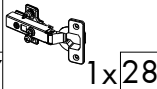
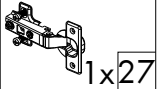

M

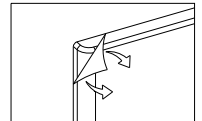
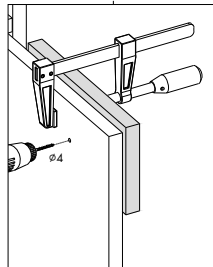
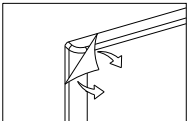
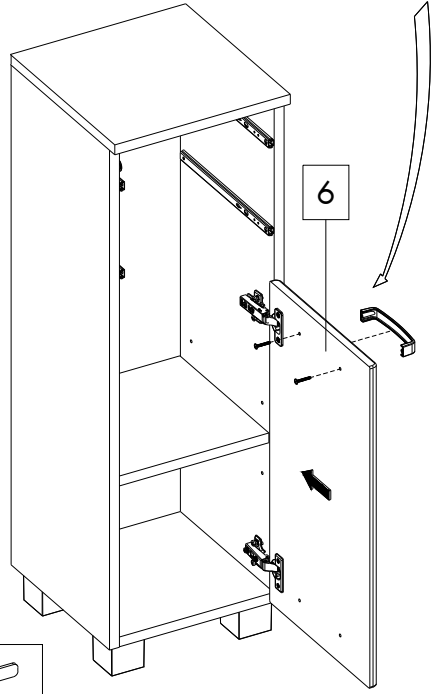
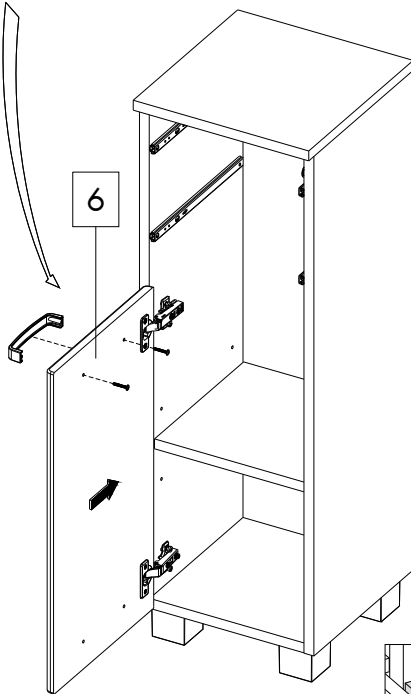
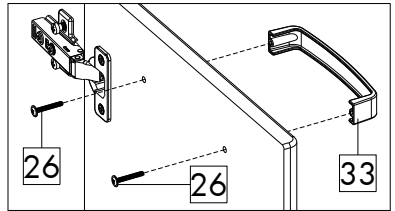
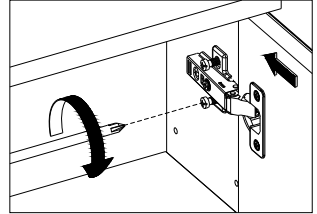
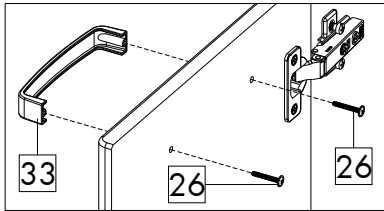
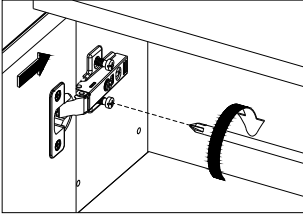
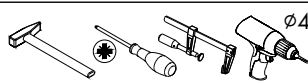
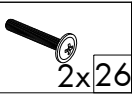
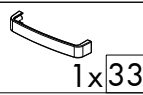

N

4x21

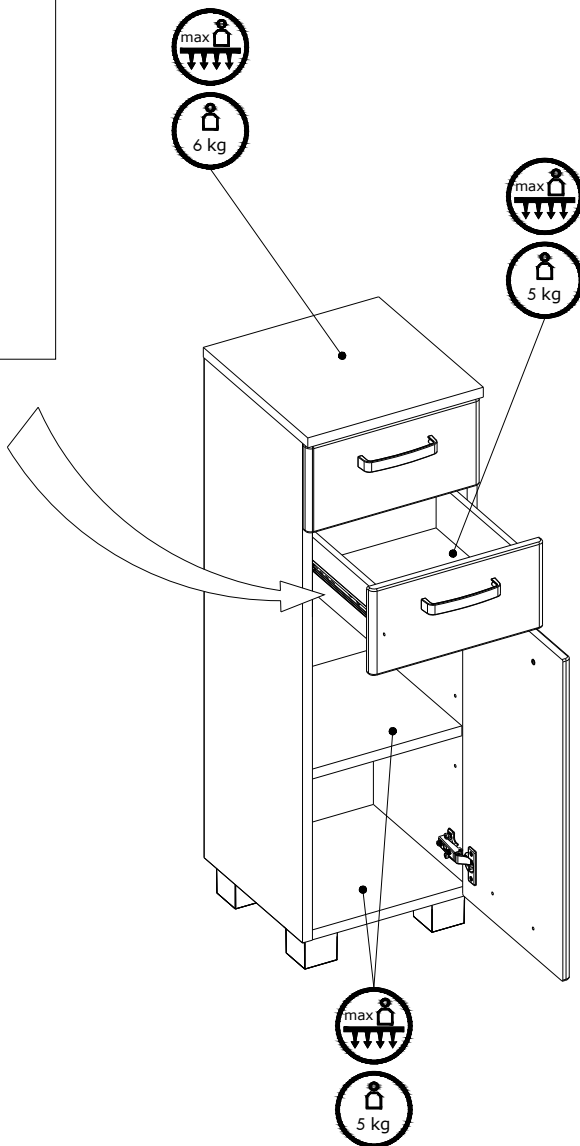
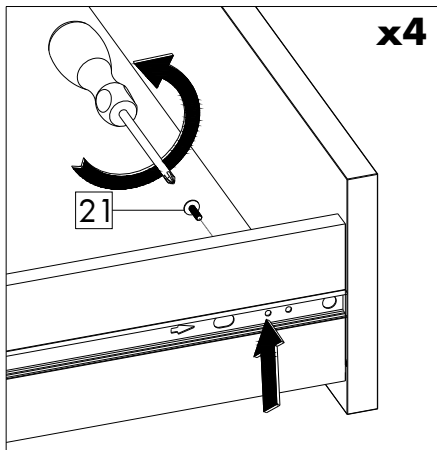
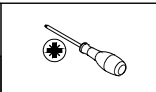

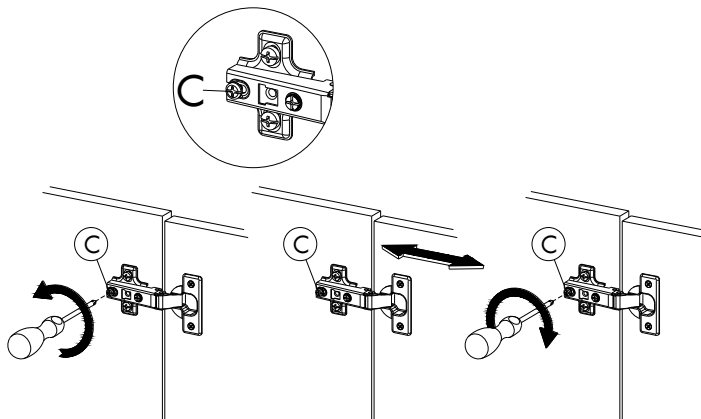
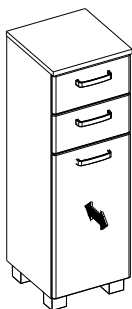
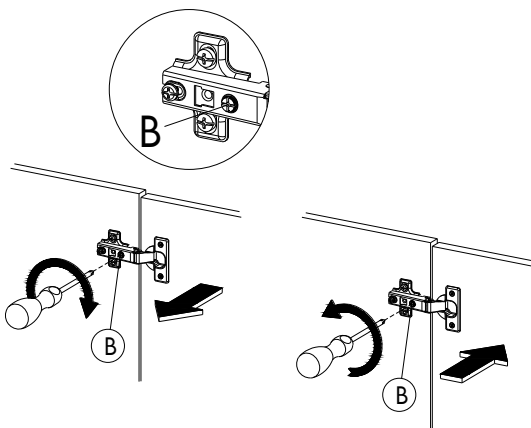
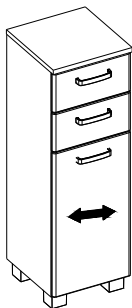
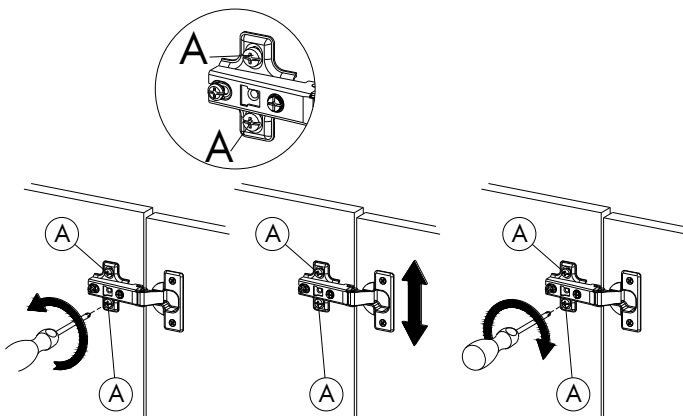
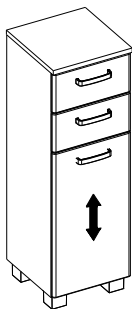
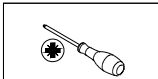

MEBLOMASTER sp. j.
Zelce I 3a
07-100 Wegrów
POLAND

reklamacje@meblomaster.pl
+48 (25) 740 26 21

MR1530
08 / 2025

IAN 508865_2507

